

Features

- Proprietary α SiC MOSFET technology
- Low loss, with low $R_{DS, ON}$
- Fast switching with low R_G and low capacitance
- Optimized gate drive voltage ($V_{GS} = 15V$)
- Low reverse recovery diode (Q_{rr})
- AEC-Q101 Automotive Qualified

Applications

- xEV Charger
- Electric Vehicle Supply Equipment (EVSE)
- Motor Drives
- Automotive Inverters

Pin Configuration

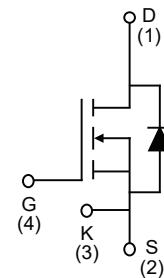
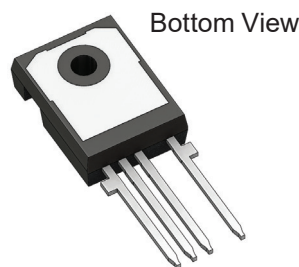
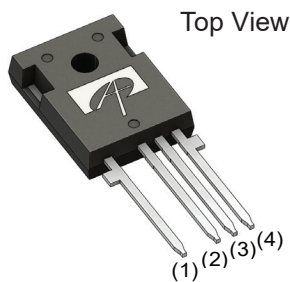

Product Summary

$V_{DS} @ T_{J, max}$	750 V
I_{DM}	200 A
$R_{DS(ON), typ}$	15 m Ω
Q_{rr}	211 nC
$E_{OSS} @ 400V$	36 μ J
100% UIS Tested	

Ordering Part Number	Package Type	Form	Shipping Quantity
AOM015V75X2Q	TO-247-4L	Tube	30/Tube

Absolute Maximum Ratings

($T_A = 25^\circ C$, unless otherwise noted)

Symbol	Parameter	AOM015V75X2Q	Units
V_{DS}	Drain-Source Voltage	750	V
$V_{GS, MAX}$	Gate-Source Voltage	Maximum	-8/+18
$V_{GS, OP, TRANS}$		Max Transient ^(A)	-8/+20
$V_{GS, OP}$		Recommended Operating ^(B)	-5/+15
I_D	Continuous Drain Current	$T_C = 25^\circ C$	96
		$T_C = 100^\circ C$	67
I_{DM}	Pulsed Drain Current ^(C)	200	A
E_{AS}	Single Pulsed Avalanche Energy ^(D)	1.8	J
P_D	Power Dissipation ^(C)	312	W
T_J, T_{STG}	Junction and Storage Temperature Range	-55 to 175	$^\circ C$
T_L	Maximum lead temperature for soldering purpose, 1/8" from case for 5 seconds	300	$^\circ C$

Thermal Characteristics

Symbol	Parameter	AOM015V75X2Q	Units
R _{θJA}	Maximum Junction-to-Ambient ^(E,F)	40	°C/W
R _{θJC}	Maximum Junction-to-Case ^(G)	0.48	°C/W

Electrical Characteristics

(T_A = 25°C, unless otherwise noted)

Symbol	Parameter	Conditions	Min	Typ	Max	Units	
STATIC							
BV _{DSS}	Drain-Source Breakdown Voltage	I _D = 250 μA, V _{GS} = 0 V, T _J = 25°C	750			V	
		I _D = 250 μA, V _{GS} = 0 V, T _J = 150°C	750			V	
I _{DSS}	Zero Gate Voltage Drain Current	V _{DS} = 750 V, V _{GS} = 0 V			100	μA	
I _{GSS}	Gate-Body Leakage Current	V _{DS} = 0 V, V _{GS} = +15/-5 V			250	nA	
V _{GS(th)}	Gate Threshold Voltage	V _{DS} = V _{GS} , I _D = 24 mA	1.8	2.5	3.5	V	
R _{DS(ON)}	Static Drain-Source On-Resistance	V _{GS} = 15 V, I _D = 24 A		15	22	mΩ	
		T _J = 175°C		23		mΩ	
g _{FS}	Forward Transconductance	V _{DS} = 20 V, I _D = 24 V		23		S	
V _{SD}	Diode Forward Voltage	I _S = 24 A, V _{GS} = -5 V		4	5	V	
DYNAMIC							
C _{iss}	Input Capacitance	V _{GS} = 0 V, V _{DS} = 400 V, f = 1 MHz		4880		pF	
C _{oss}	Output Capacitance			371		pF	
C _{rss}	Reverse Transfer Capacitance			25		pF	
E _{oss}	Coss Stored Energy			36		μJ	
R _G	Gate Resistance	f = 1 MHz		1.1		Ω	
SWITCHING							
Q _g	Total Gate Charge	V _{GS} = -5/+15 V, V _{DS} = 520 V, I _D = 24 A		152		nC	
Q _{gs}	Gate Source Charge			58		nC	
Q _{gd}	Gate Drain Charge			30		nC	
t _{D(on)}	Turn-On Delay Time	V _{GS} = -5 V/+15 V, V _{DS} = 400 V, I _D = 50 A, R _{G,ON} = 2 Ω, R _{G,OFF} = 0 Ω		11		ns	
t _r	Turn-On Rise Time			13		ns	
t _{D(off)}	Turn-Off Delay Time			16		ns	
t _f	Turn-Off Fall Time			5		ns	
E _{on}	Turn-On Energy		L = 30 μH		180		μJ
E _{off}	Turn-Off Energy	FWD: AOM015V75X2Q		5		μJ	
E _{tot}	Total Switching Energy			185		μJ	
t _{rr}	Body Diode Reverse Recovery Time	I _F = 50 A, dI/dt = 2500 A/us, V _{DS} = 400 V		17.5		ns	
I _{rm}	Peak Reverse Recovery Current				20		A
Q _{rr}	Body Diode Reverse Recovery Charge				211		nC

Notes:

- t_{ON} < 1% *(Duty Cycle)/(Frequency), t < 25 hrs over lifetime
- Device can be operated at V_{GS} = 0/15 V. Actual operating VGS will depend on application specifics such as parasitic inductance and dV/dt but should not exceed maximum ratings.
- The power dissipation P_D is based on T_{J(MAX)} = 175°C, using junction-to-case thermal resistance, and is more useful in setting the upper dissipation limit for cases where additional heatsinking is used.
- L = 5 mH, I_{AS} = 27 A, R_G = 10 Ω, Starting T_J = 25°C.
- The value of R_{θJA} is measured with the device in a still air environment

- with T_A = 25°C.
- The R_{θJA} is the sum of the thermal impedance from junction to case R_{θJC} and case to ambient.
- The value of R_{θJC} is measured with the device mounted to a large heatsink, assuming a maximum junction temperature of T_{J(MAX)} = 175°C.
- The static characteristics in Figures 1 to 8 are obtained using < 300 μs pulses, duty cycle 0.5% max.
- These curves are based on R_{θJC} which is measured with the device mounted to a large heatsink, assuming a maximum junction temperature of T_{J(MAX)} = 175°C. The SOA curve provides a single pulse rating.

Typical Electrical and Thermal Characteristics

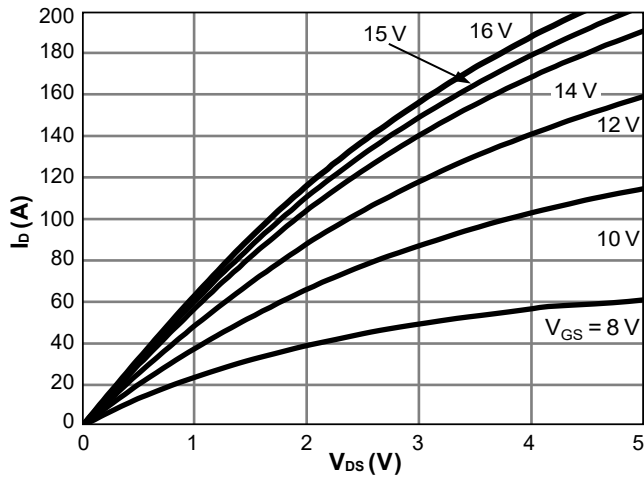

Figure 1. On-Region Characteristics $T_J = 25^\circ\text{C}$

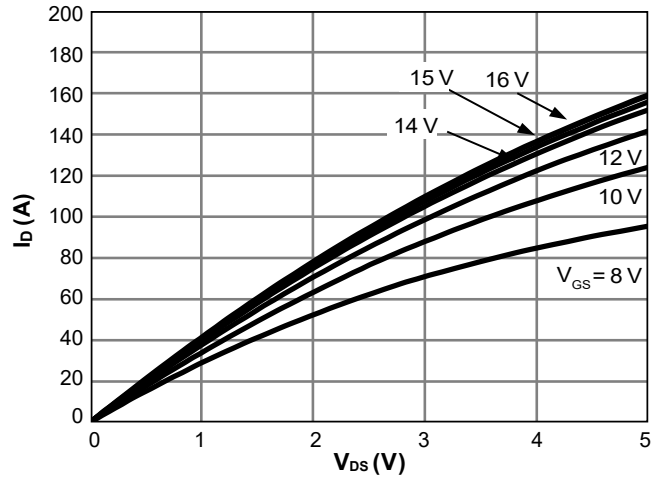

Figure 2. On-Region Characteristics $T_J = 175^\circ\text{C}$

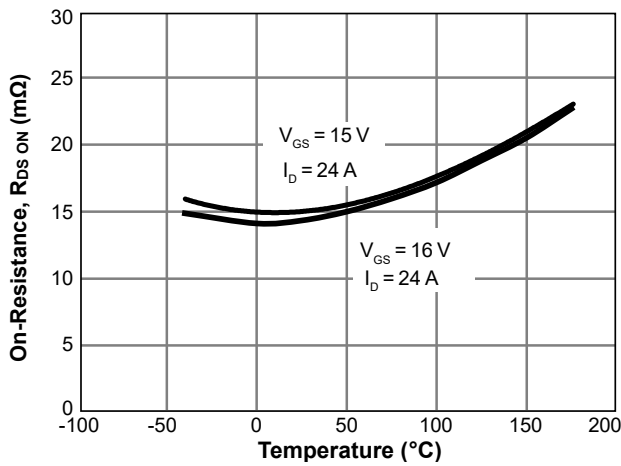

Figure 3. On-Resistance vs. Junction Temperature

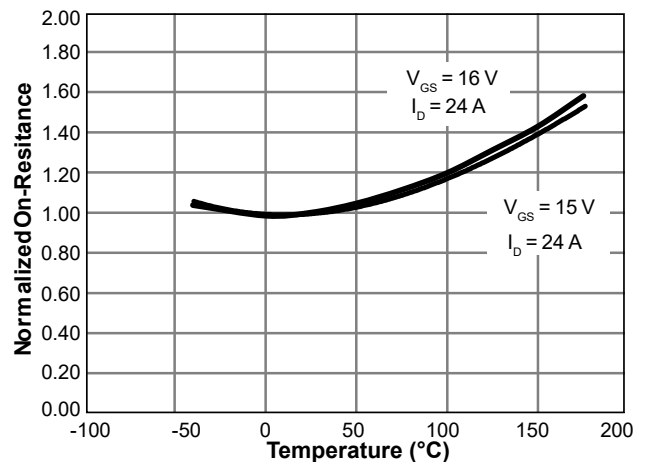

Figure 4. Normalized On-Resistance vs. Junction Temperature

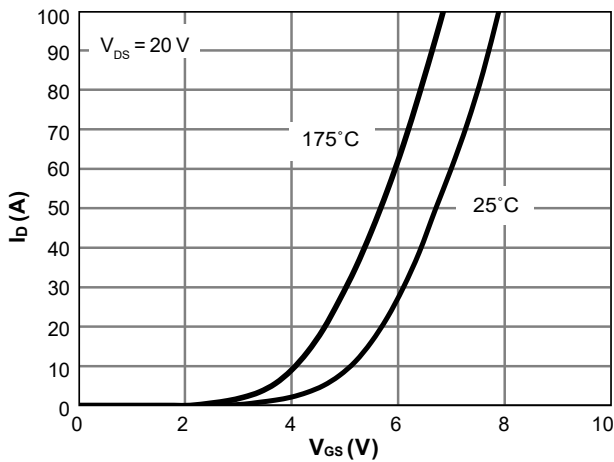

Figure 5. Transfer Characteristics

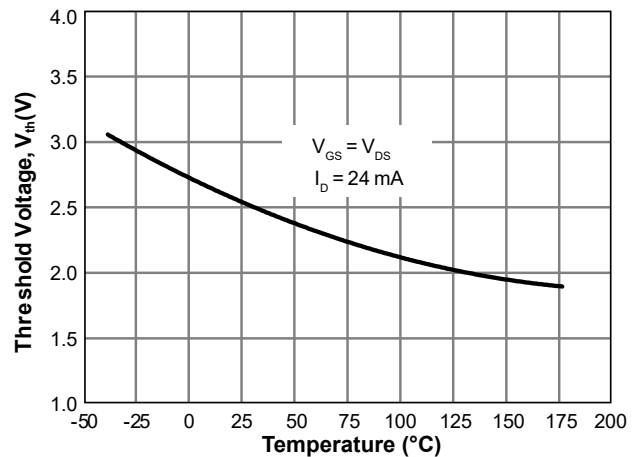

Figure 6. Threshold Voltage vs. Junction Temperature

Typical Electrical and Thermal Characteristics (Continued)

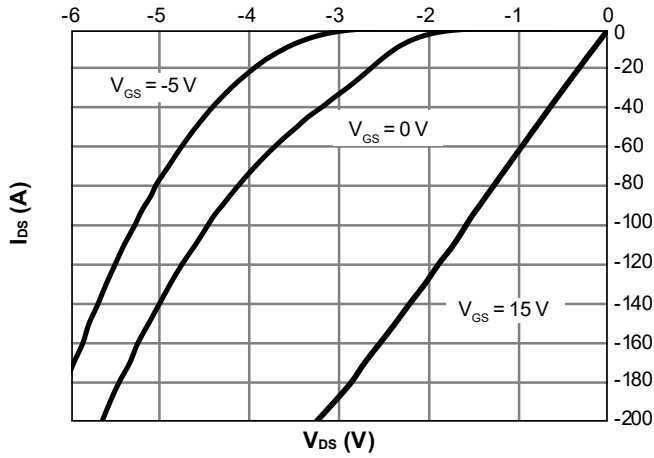

Figure 7. Body-Diode Characteristics at 25°C

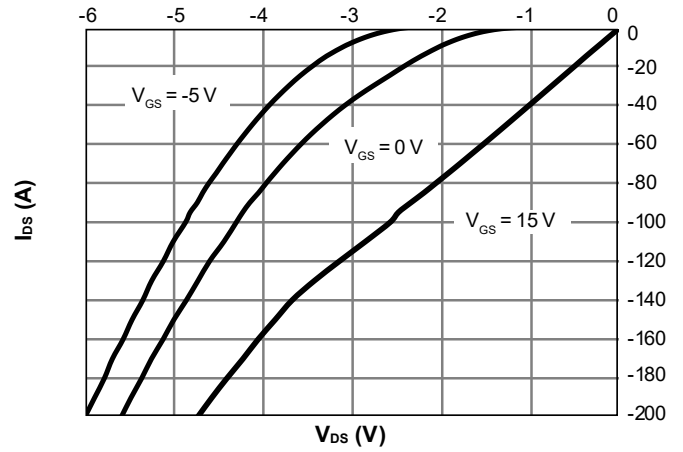

Figure 8. Body-Diode Characteristics at 175°C

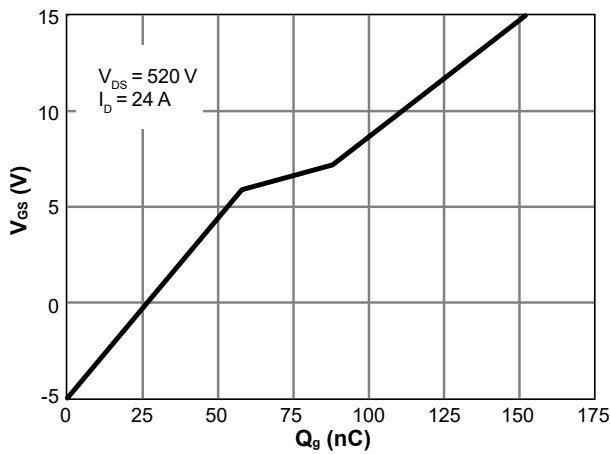

Figure 9. Gate-Charge Characteristics

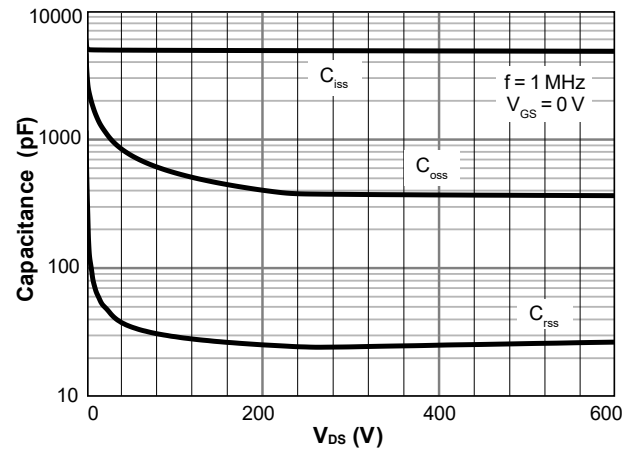

Figure 10. Capacitance Characteristics

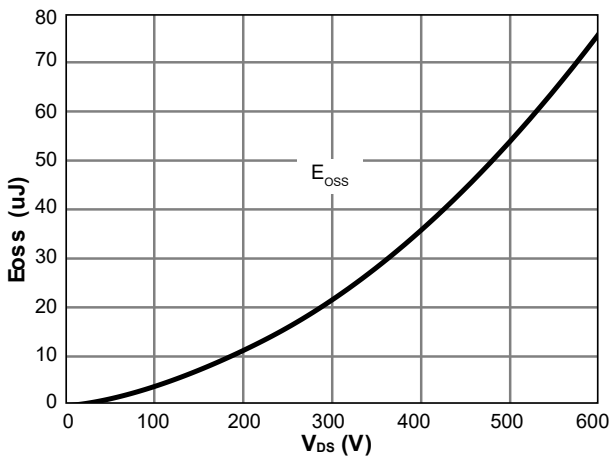

Figure 11. Coss stored Energy

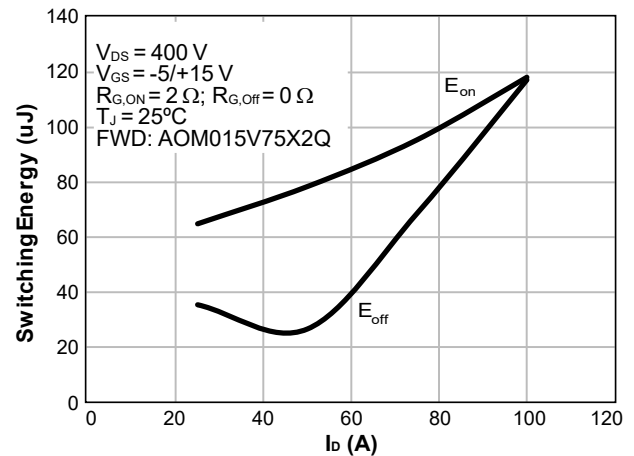

Figure 12. Switching Energy vs. Drain Current

Typical Electrical and Thermal Characteristics (Continued)

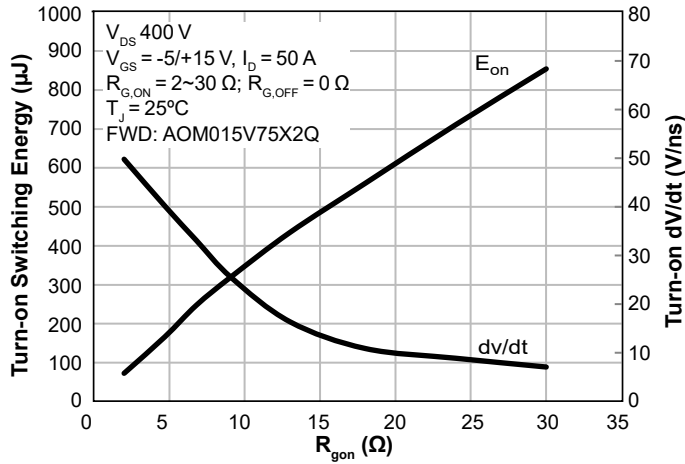

Figure 13. Turn-On Energy and dV/dt vs. External Gate Resistance

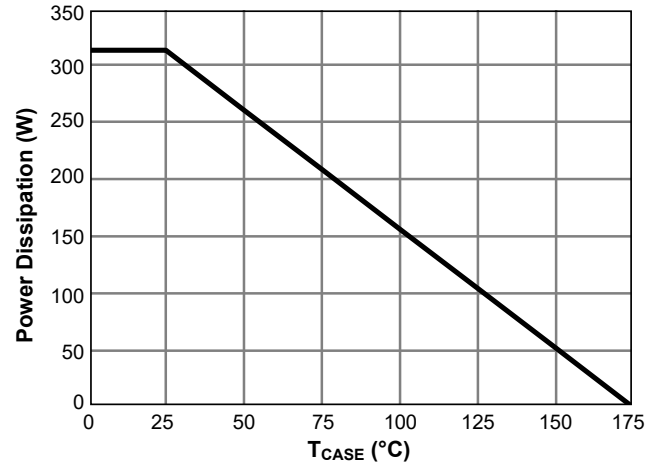

Figure 14. Power De-rating (Note I)

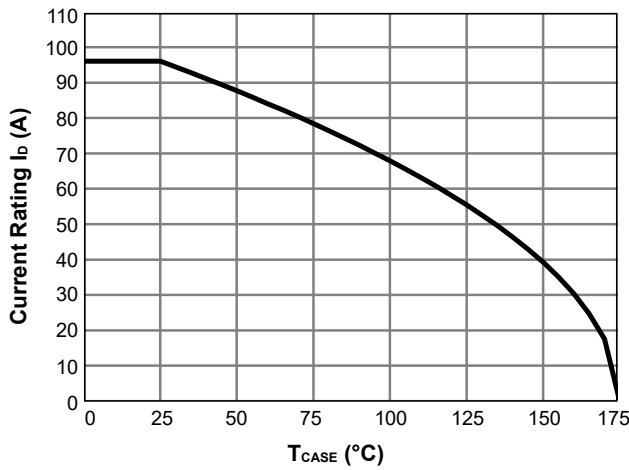

Figure 15. Current De-rating (Note I)

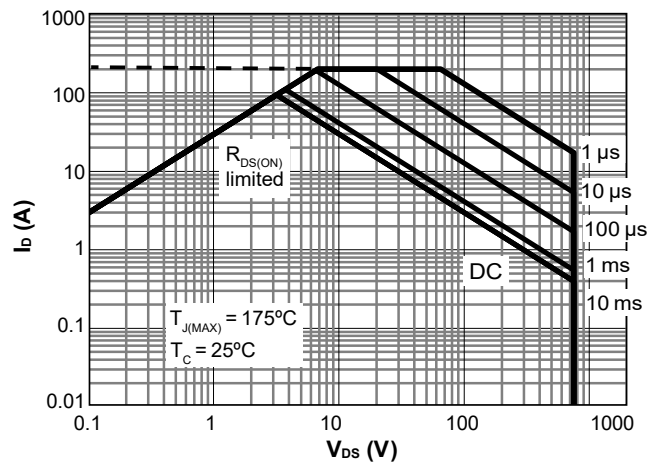

Figure 16. Maximum Forward Biased Safe Operating Area for AOM015V75X2Q (Note I)

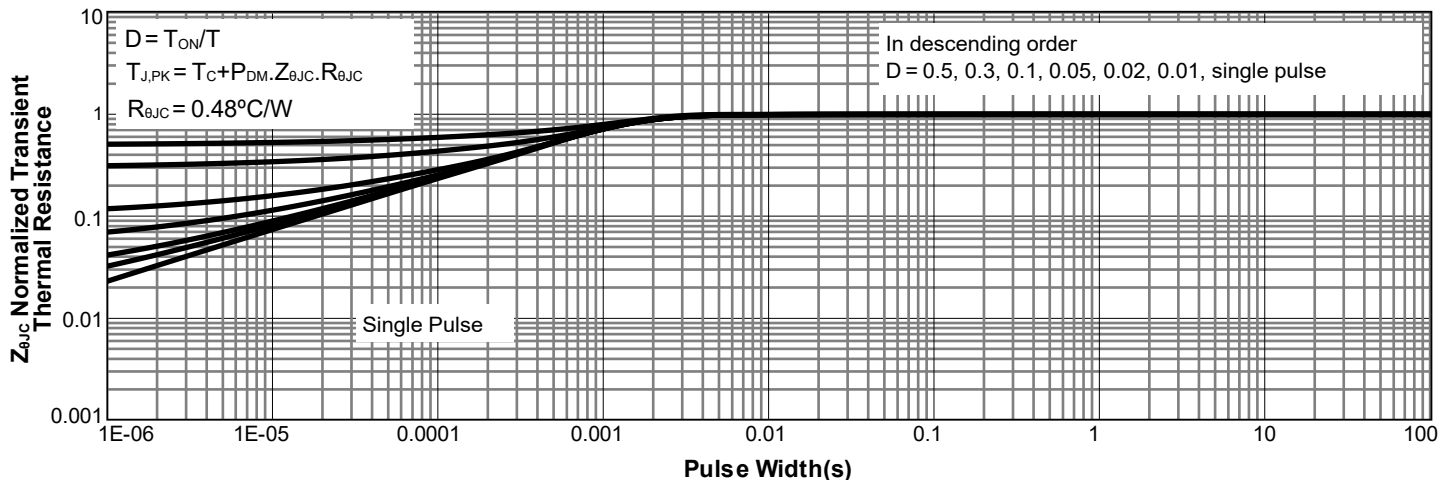

Figure 17. Normalized Maximum Transient Thermal Impedance for AOM015V75X2Q (Note I)

Test Circuits and Waveforms

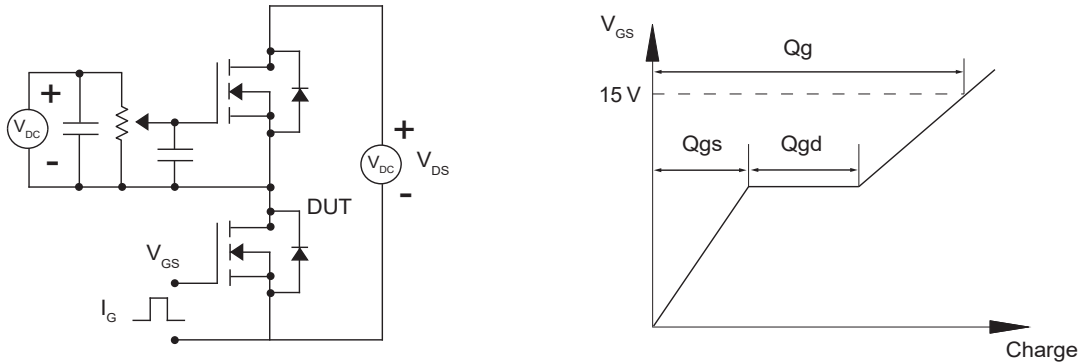

Figure 18. Gate Charge Test Circuits and Waveforms

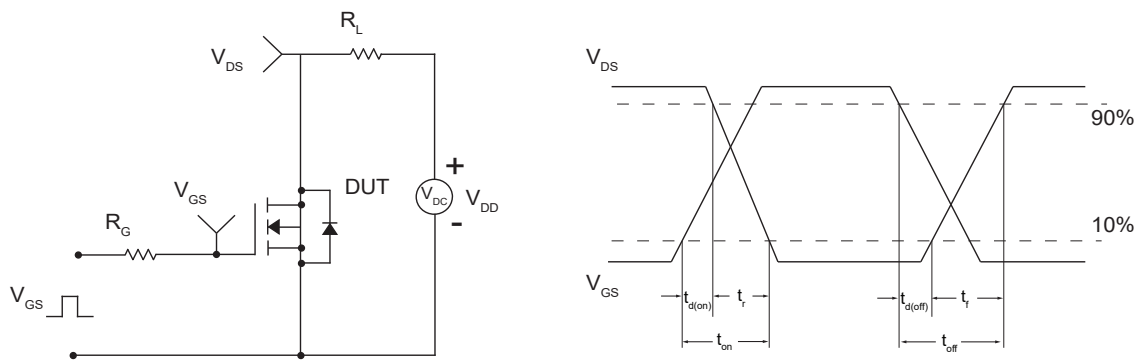

Figure 19. Resistive Switching Test Circuit and Waveforms

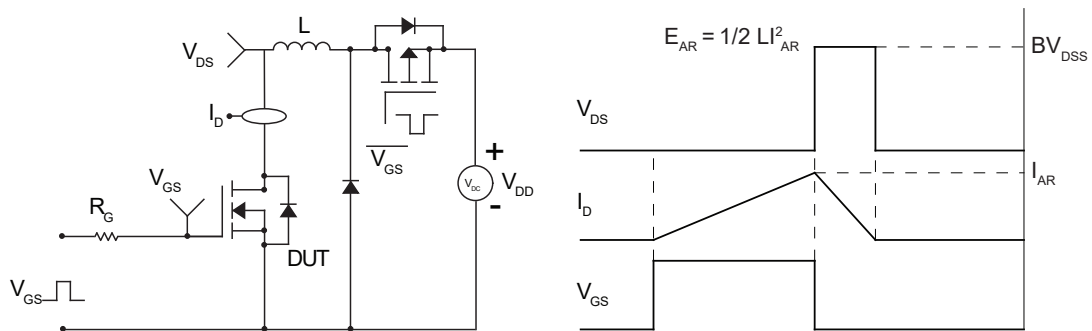

Figure 20. Unclamped Inductive Switching (UIS) Test Circuit and Waveforms

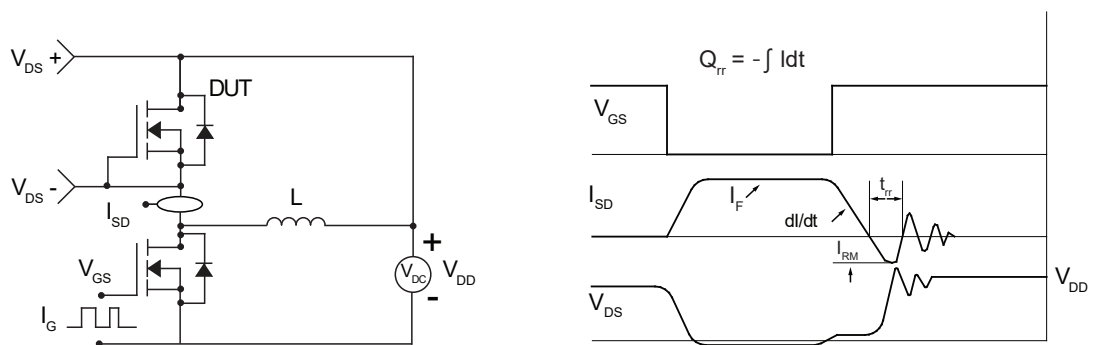
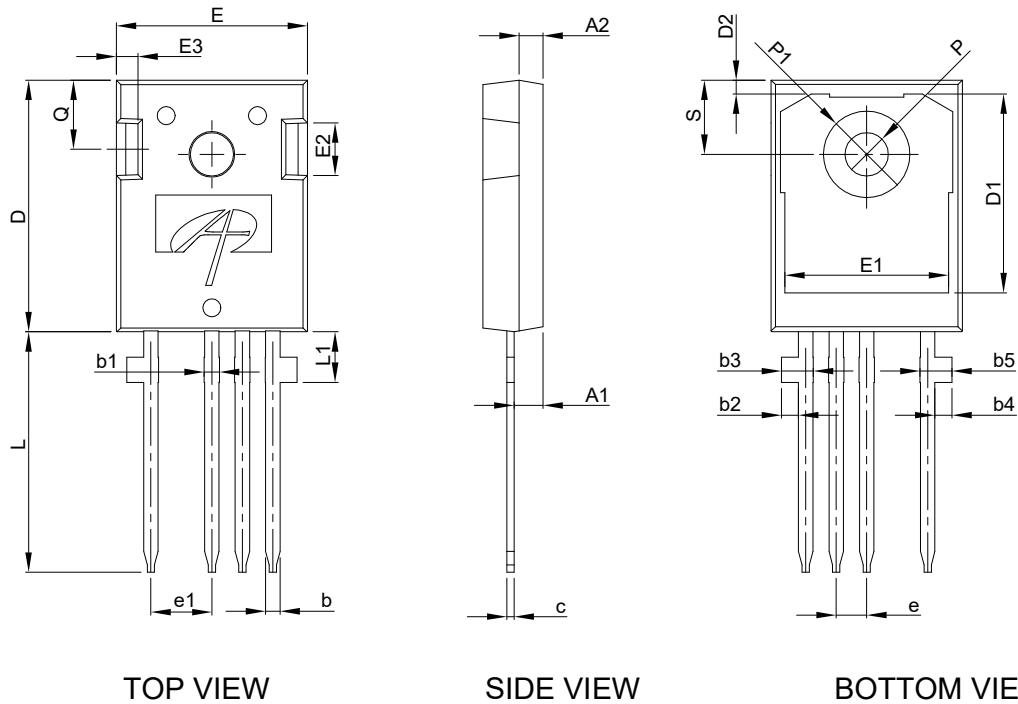

Figure 21. Diode Recovery Test Circuits and Waveforms

Package Dimensions, TO-247-4L



TOP VIEW

SIDE VIEW

BOTTOM VIEW

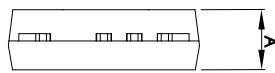

SIDE VIEW

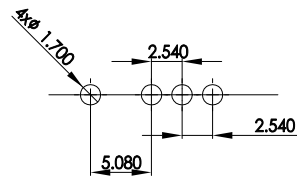

RECOMMENDED THROUGH HOLES FOR LAND PATTERN

NOTE:

1. CONTROLLED DIMENSIONS ARE IN MILLIMETERS.

SYMBOLS	DIM. IN MM			DIM. IN INCH		
	MIN.	NOM.	MAX.	MIN.	NOM.	MAX.
A	4.90	5.00	5.10	0.193	0.197	0.201
A1	2.32	2.42	2.52	0.091	0.095	0.099
A2	1.90	2.00	2.10	0.075	0.079	0.083
b	1.17	1.22	1.27	0.046	0.048	0.050
b1	1.20	1.30	1.40	0.047	0.051	0.055
b2	1.31	1.41	1.51	0.052	0.056	0.059
b3	2.45	2.65	2.85	0.096	0.104	0.112
b4	1.31	1.41	1.51	0.052	0.056	0.059
b5	2.45	2.65	2.85	0.096	0.104	0.112
c	0.57	0.62	0.67	0.022	0.024	0.026
D	20.80	20.95	21.10	0.819	0.825	0.831
D1	16.25	16.55	16.85	0.640	0.652	0.663
D2	1.00	1.15	1.30	0.039	0.045	0.051
E	15.77	15.92	16.07	0.621	0.627	0.632
E1	13.43	13.63	13.83	0.529	0.536	0.544
E2	4.29	4.39	4.49	0.169	0.173	0.177
E3	1.70	1.80	1.90	0.067	0.071	0.075
e	2.54BSC			0.1000BSC		
e1	5.08BSC			0.2000BSC		
N	4			4		
L	19.82	20.02	20.22	0.780	0.788	0.796
L1	4.01	4.21	4.41	0.158	0.166	0.174
P	3.50	3.60	3.70	0.138	0.142	0.146
P1	7.00	7.20	7.40	0.276	0.283	0.291
Q	5.65	5.75	5.85	0.222	0.226	0.230
S	6.07	6.17	6.27	0.239	0.243	0.247

Part Marking

AOM015V75X2Q
TO-247-4L

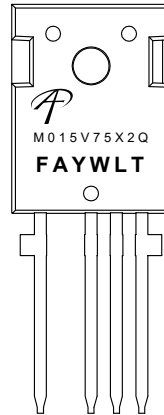

LEGAL DISCLAIMER

Applications or uses as critical components in life support devices or systems are not authorized. Alpha and Omega Semiconductor does not assume any liability arising out of such applications or uses of its products. AOS reserves the right to make changes to product specifications without notice. It is the responsibility of the customer to evaluate suitability of the product for their intended application. Customer shall comply with applicable legal requirements, including all applicable export control rules, regulations and limitations.

AOS's products are provided subject to AOS's terms and conditions of sale which are set forth at:

http://www.aosmd.com/terms_and_conditions_of_sale

LIFE SUPPORT POLICY

ALPHA AND OMEGA SEMICONDUCTOR PRODUCTS ARE NOT AUTHORIZED FOR USE AS CRITICAL COMPONENTS IN LIFE SUPPORT DEVICES OR SYSTEMS.

As used herein:

1. Life support devices or systems are devices or systems which, (a) are intended for surgical implant into the body or (b) support or sustain life, and (c) whose failure to perform when properly used in accordance with instructions for use provided in the labeling, can be reasonably expected to result in a significant injury of the user.
2. A critical component in any component of a life support, device, or system whose failure to perform can be reasonably expected to cause the failure of the life support device or system, or to affect its safety or effectiveness.