

General Description

- Trench Power MOSFET technology
- Low $R_{DS(ON)}$
- Low Gate Charge
- Excellent Thermal Performance
- RoHS and Halogen-Free Compliant

Applications

- Pch+Nch Complementary MOSFET for DC-FAN

Product Summary

	Q1	Q2
V_{DS}	30V	-30V
I_D (at $V_{GS}=10V$)	8A	-12A
$R_{DS(ON)}$ (at $V_{GS}=10V$)	< 25m Ω	< 27m Ω
$R_{DS(ON)}$ (at $V_{GS}=4.5V$)	< 38m Ω	< 45m Ω

100% UIS Tested
 100% Rg Tested

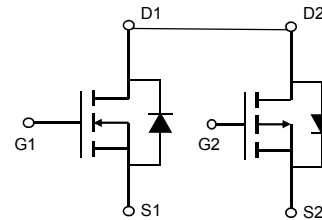
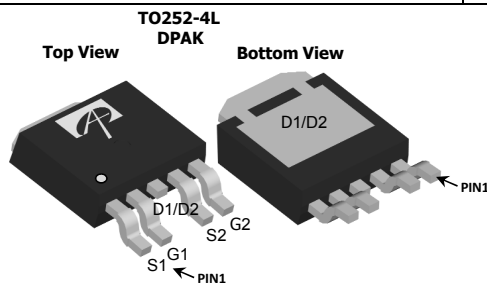

Orderable Part Number	Package Type	Form	Minimum Order Quantity
AOD607A	TO-252-4L	Tape & Reel	2500

Absolute Maximum Ratings $T_A=25^\circ\text{C}$ unless otherwise noted

Parameter	Symbol	Max Q1	Max Q2	Units
Drain-Source Voltage	V_{DS}	30	-30	V
Gate-Source Voltage	V_{GS}	± 20	± 20	V
Continuous Drain Current ^G	I_D	8	-12	A
Current ^G		$T_C=25^\circ\text{C}$	8	
Pulsed Drain Current ^C	I_{DM}	44	-48	
Continuous Drain Current ^G	I_{DSM}	8	12	A
Current ^G		$T_A=25^\circ\text{C}$	8	
Avalanche Current ^C	I_{AS}	12	-18	A
Avalanche energy	E_{AS}	7	16	mJ
V_{DS} Spike	V_{SPIKE}	36	-36	V
Power Dissipation ^B	P_D	19	30	W
		$T_C=25^\circ\text{C}$	7.5	
Power Dissipation ^A	P_{DSM}	6.2	6.2	W
		$T_A=25^\circ\text{C}$	4.0	
Junction and Storage Temperature Range	T_J, T_{STG}	-55 to 150		$^\circ\text{C}$

Thermal Characteristics

Parameter	Symbol	Typ Q1	Typ Q2	Max Q1	Max Q2	Units
Maximum Junction-to-Ambient ^A	$R_{\theta JA}$	15	15	20	20	$^\circ\text{C/W}$
Maximum Junction-to-Ambient ^{A,D}		Steady-State	40	40	50	50
Maximum Junction-to-Case	$R_{\theta JC}$	5.0	3.2	6.5	4.2	$^\circ\text{C/W}$

Q1 Electrical Characteristics (T_J=25°C unless otherwise noted)

Symbol	Parameter	Conditions	Min	Typ	Max	Units
STATIC PARAMETERS						
BV _{DSS}	Drain-Source Breakdown Voltage	I _D =250μA, V _{GS} =0V	30			V
I _{DSS}	Zero Gate Voltage Drain Current	V _{DS} =30V, V _{GS} =0V T _J =55°C			1 5	μA
I _{GSS}	Gate-Body leakage current	V _{DS} =0V, V _{GS} =±20V			100	nA
V _{GS(th)}	Gate Threshold Voltage	V _{DS} =V _{GS} , I _D =250μA	1.5	2.1	2.6	V
R _{DS(on)}	Static Drain-Source On-Resistance	V _{GS} =10V, I _D =8A T _J =125°C		20.5	25	mΩ
		V _{GS} =4.5V, I _D =5A		28	38	
g _{FS}	Forward Transconductance	V _{DS} =5V, I _D =8A		20		S
V _{SD}	Diode Forward Voltage	I _S =1A, V _{GS} =0V		0.75	1	V
I _S	Maximum Body-Diode Continuous Current ^G				8	A
DYNAMIC PARAMETERS						
C _{iss}	Input Capacitance	V _{GS} =0V, V _{DS} =15V, f=1MHz		395		pF
C _{oss}	Output Capacitance			67		pF
C _{rss}	Reverse Transfer Capacitance			41		pF
R _g	Gate resistance	f=1MHz	0.9	1.8	2.8	Ω
SWITCHING PARAMETERS						
Q _g (10V)	Total Gate Charge	V _{GS} =10V, V _{DS} =15V, I _D =8A		7.2	15	nC
Q _g (4.5V)	Total Gate Charge			3.5	7	nC
Q _{gs}	Gate Source Charge			1.3		nC
Q _{gd}	Gate Drain Charge			1.7		nC
t _{D(on)}	Turn-On DelayTime	V _{GS} =10V, V _{DS} =15V, R _L =1.87Ω, R _{GEN} =3Ω		4.5		ns
t _r	Turn-On Rise Time			2.7		ns
t _{D(off)}	Turn-Off DelayTime			14.9		ns
t _f	Turn-Off Fall Time			2.9		ns
t _{rr}	Body Diode Reverse Recovery Time	I _F =8A, di/dt=500A/μs		6.0		ns
Q _{rr}	Body Diode Reverse Recovery Charge	I _F =8A, di/dt=500A/μs		6.6		nC

A. The value of R_{θJA} is measured with the device mounted on 1in² FR-4 board with 2oz. Copper, in a still air environment with T_A=25° C. The Power dissipation P_{DSM} is based on R_{θJA} ≤ 10s and the maximum allowed junction temperature of 150° C. The value in any given application depends on the user's specific board design.

B. The power dissipation P_D is based on T_{J(MAX)}=150° C, using junction-to-case thermal resistance, and is more useful in setting the upper dissipation limit for cases where additional heatsinking is used.

C. Single pulse width limited by junction temperature T_{J(MAX)}=150° C.

D. The R_{θJA} is the sum of the thermal impedance from junction to case R_{θJC} and case to ambient.

E. The static characteristics in Figures 1 to 6 are obtained using <300μs pulses, duty cycle 0.5% max.

F. These curves are based on the junction-to-case thermal impedance which is measured with the device mounted to a large heatsink, assuming a maximum junction temperature of T_{J(MAX)}=150° C. The SOA curve provides a single pulse rating.

G. The maximum current rating is package limited.

H. These tests are performed with the device mounted on 1 in² FR-4 board with 2oz. Copper, in a still air environment with T_A=25° C.

APPLICATIONS OR USE AS CRITICAL COMPONENTS IN LIFE SUPPORT DEVICES OR SYSTEMS ARE NOT AUTHORIZED. AOS DOES NOT ASSUME ANY LIABILITY ARISING OUT OF SUCH APPLICATIONS OR USES OF ITS PRODUCTS. AOS RESERVES THE RIGHT TO IMPROVE PRODUCT DESIGN,FUNCTIONS AND RELIABILITY WITHOUT NOTICE.

TYPICAL ELECTRICAL AND THERMAL CHARACTERISTICS

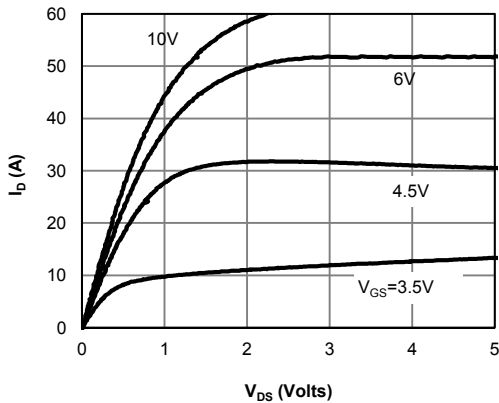

Figure 1: On-Region Characteristics (Note E)

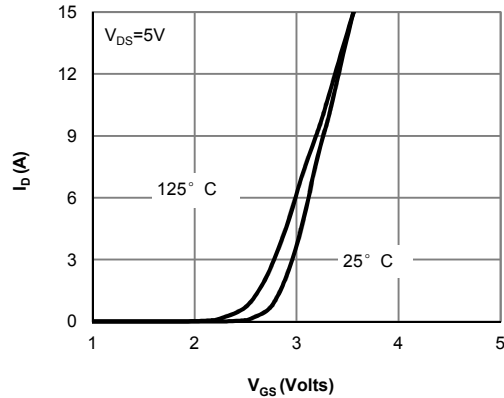

Figure 2: Transfer Characteristics (Note E)

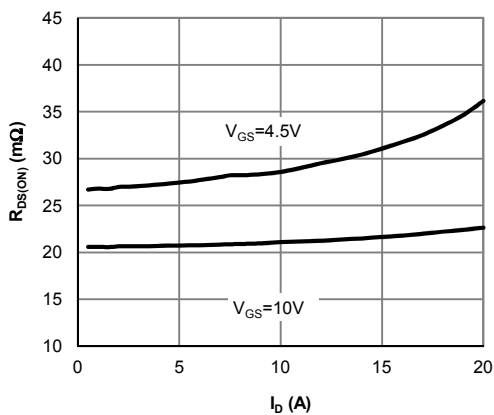

Figure 3: On-Resistance vs. Drain Current and Gate Voltage (Note E)

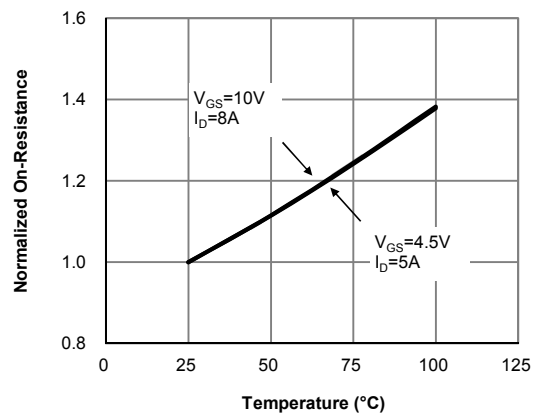

Figure 4: On-Resistance vs. Junction Temperature (Note E)

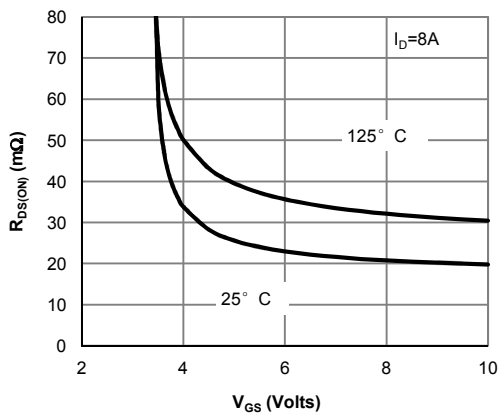

Figure 5: On-Resistance vs. Gate-Source Voltage (Note E)

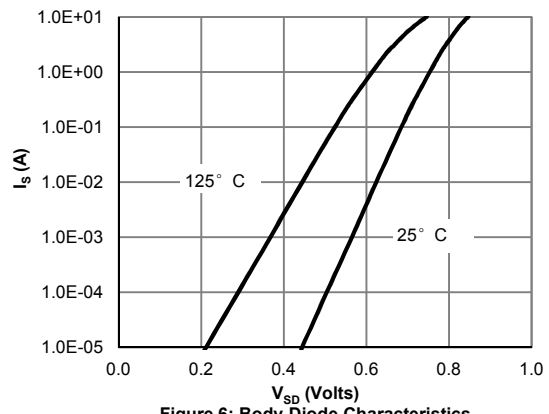

Figure 6: Body-Diode Characteristics (Note E)

TYPICAL ELECTRICAL AND THERMAL CHARACTERISTICS

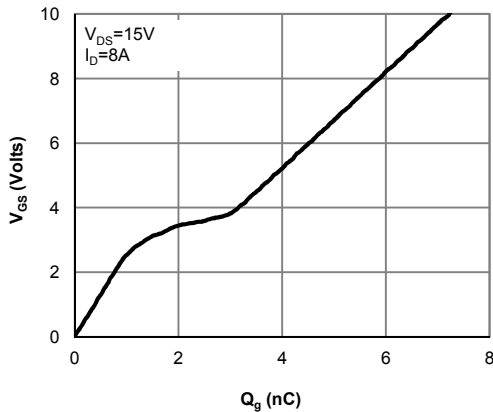

Figure 7: Gate-Charge Characteristics

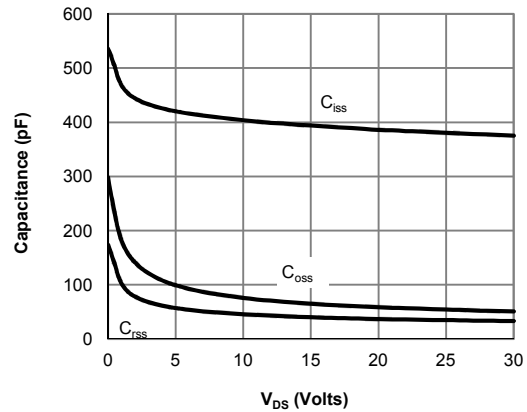

Figure 8: Capacitance Characteristics

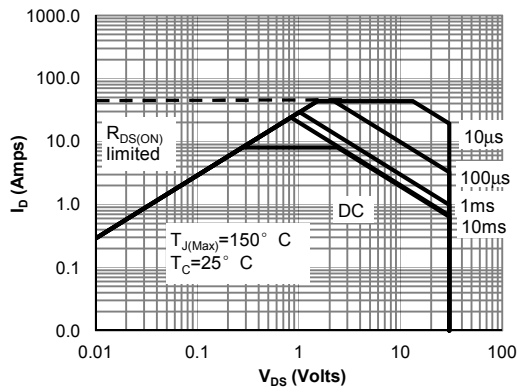

Figure 9: Maximum Forward Biased Safe Operating Area (Note F)

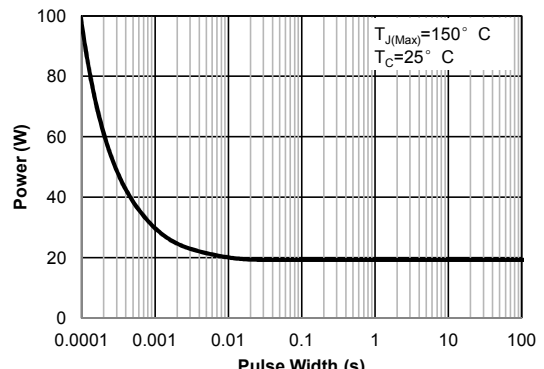

Figure 10: Single Pulse Power Rating Junction-to-Case (Note F)

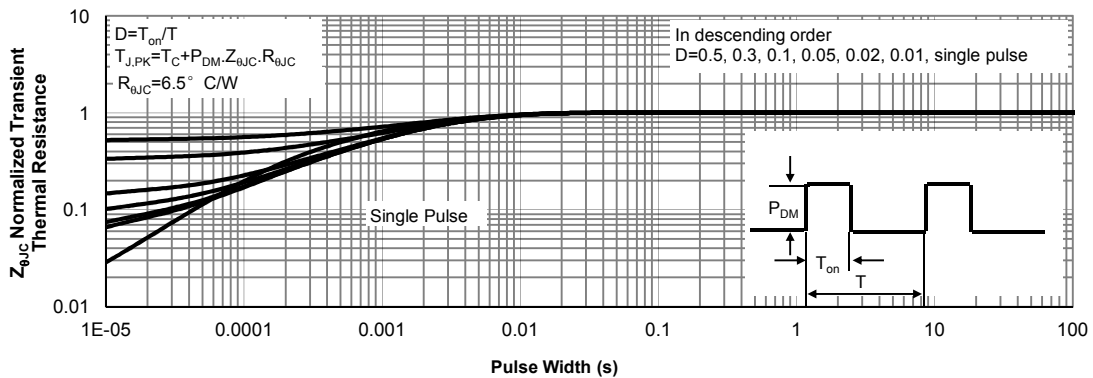

Figure 11: Normalized Maximum Transient Thermal Impedance (Note F)

TYPICAL ELECTRICAL AND THERMAL CHARACTERISTICS

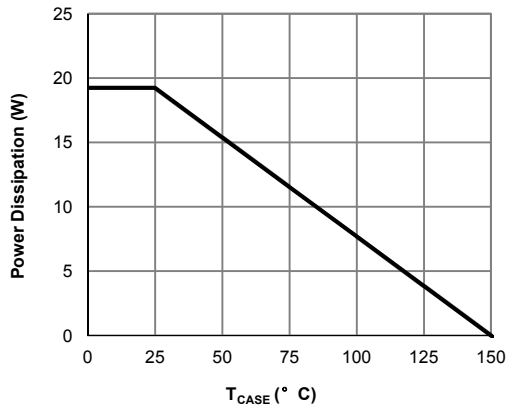

Figure 12: Power De-rating (Note F)

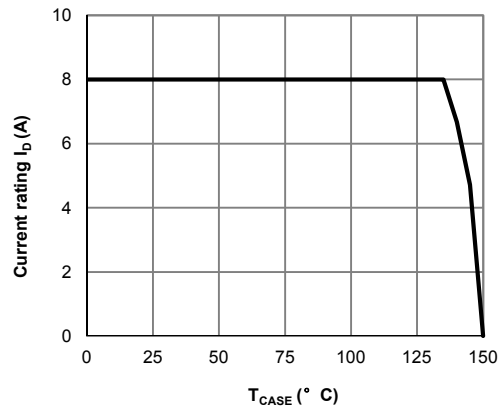

Figure 13: Current De-rating (Note F)

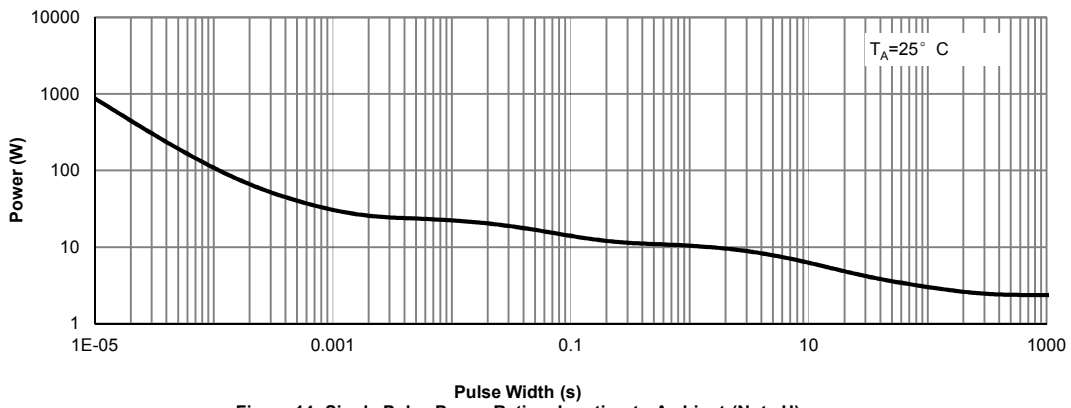

Figure 14: Single Pulse Power Rating Junction-to-Ambient (Note H)

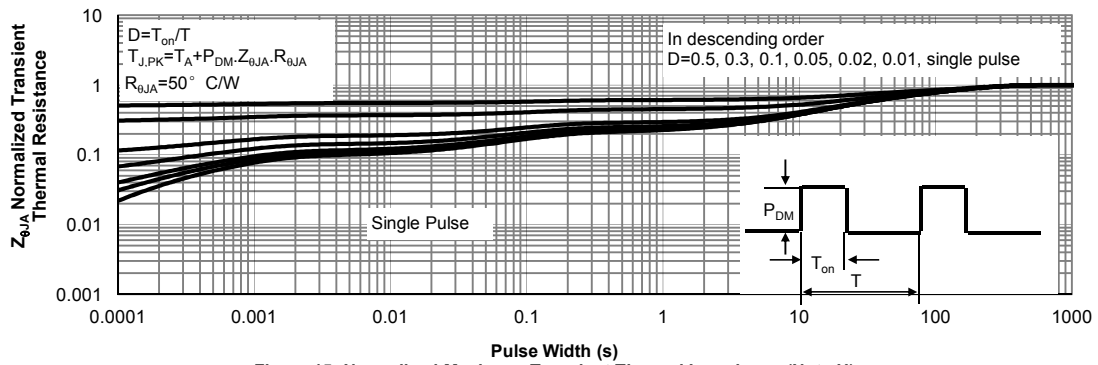

Figure 15: Normalized Maximum Transient Thermal Impedance (Note H)

Q2 Electrical Characteristics (T_J=25°C unless otherwise noted)

Symbol	Parameter	Conditions	Min	Typ	Max	Units
STATIC PARAMETERS						
BV _{DSS}	Drain-Source Breakdown Voltage	I _D =-250μA, V _{GS} =0V	-30			V
I _{DSS}	Zero Gate Voltage Drain Current	V _{DS} =-30V, V _{GS} =0V T _J =55°C			-1 -5	μA
I _{GSS}	Gate-Body leakage current	V _{DS} =0V, V _{GS} =±20V			±100	nA
V _{GS(th)}	Gate Threshold Voltage	V _{DS} =V _{GS} , I _D =-250μA	-1.3	-1.85	-2.4	V
R _{DS(on)}	Static Drain-Source On-Resistance	V _{GS} =-10V, I _D =-12A T _J =125°C		22 32	27 40	mΩ
		V _{GS} =-4.5V, I _D =-10A		33	45	
g _{FS}	Forward Transconductance	V _{DS} =-5V, I _D =-12A		19		S
V _{SD}	Diode Forward Voltage	I _S =-1A, V _{GS} =0V		-0.75	-1	V
I _S	Maximum Body-Diode Continuous Current ^G				12	A
DYNAMIC PARAMETERS						
C _{iss}	Input Capacitance	V _{GS} =0V, V _{DS} =-15V, f=1MHz		730		pF
C _{oss}	Output Capacitance			140		pF
C _{rss}	Reverse Transfer Capacitance			90		pF
R _g	Gate resistance	f=1MHz		2.1	5	Ω
SWITCHING PARAMETERS						
Q _g (10V)	Total Gate Charge	V _{GS} =-10V, V _{DS} =-15V, I _D =-12A		13.6	24	nC
Q _g (4.5V)	Total Gate Charge			6.7	12	nC
Q _{gs}	Gate Source Charge			2.5		nC
Q _{gd}	Gate Drain Charge			3.2		nC
t _{D(on)}	Turn-On DelayTime	V _{GS} =-10V, V _{DS} =-15V, R _L =1.25Ω, R _{GEN} =3Ω		8		ns
t _r	Turn-On Rise Time			6		ns
t _{D(off)}	Turn-Off DelayTime			17		ns
t _f	Turn-Off Fall Time			5		ns
t _{rr}	Body Diode Reverse Recovery Time	I _F =-12A, di/dt=500A/μs		12		ns
Q _{rr}	Body Diode Reverse Recovery Charge	I _F =-12A, di/dt=500A/μs		25.5		nC

A. The value of R_{θJA} is measured with the device mounted on 1in² FR-4 board with 2oz. Copper, in a still air environment with T_A=25° C. The Power dissipation P_{DSM} is based on R_{θJA} ≤ 10s and the maximum allowed junction temperature of 150° C. The value in any given application depends on the user's specific board design.

B. The power dissipation P_D is based on T_{J(MAX)}=150° C, using junction-to-case thermal resistance, and is more useful in setting the upper dissipation limit for cases where additional heatsinking is used.

C. Single pulse width limited by junction temperature T_{J(MAX)}=150° C.

D. The R_{θJA} is the sum of the thermal impedance from junction to case R_{θJC} and case to ambient.

E. The static characteristics in Figures 1 to 6 are obtained using <300μs pulses, duty cycle 0.5% max.

F. These curves are based on the junction-to-case thermal impedance which is measured with the device mounted to a large heatsink, assuming a maximum junction temperature of T_{J(MAX)}=150° C. The SOA curve provides a single pulse rating.

G. The maximum current rating is package limited.

H. These tests are performed with the device mounted on 1 in² FR-4 board with 2oz. Copper, in a still air environment with T_A=25° C.

APPLICATIONS OR USE AS CRITICAL COMPONENTS IN LIFE SUPPORT DEVICES OR SYSTEMS ARE NOT AUTHORIZED. AOS DOES NOT ASSUME ANY LIABILITY ARISING OUT OF SUCH APPLICATIONS OR USES OF ITS PRODUCTS. AOS RESERVES THE RIGHT TO IMPROVE PRODUCT DESIGN,FUNCTIONS AND RELIABILITY WITHOUT NOTICE.

TYPICAL ELECTRICAL AND THERMAL CHARACTERISTICS

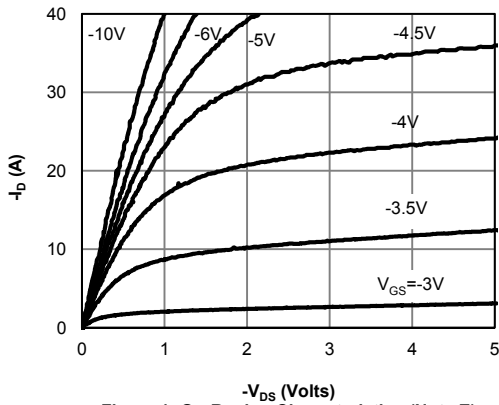

Figure 1: On-Region Characteristics (Note E)

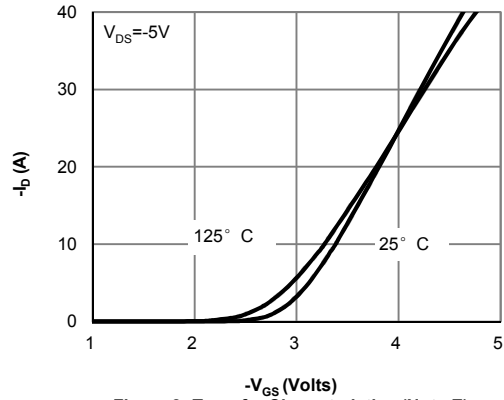

Figure 2: Transfer Characteristics (Note E)

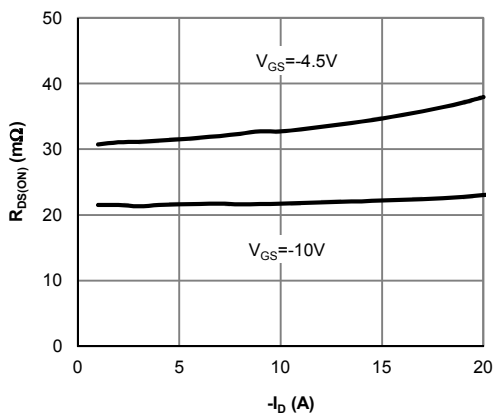

Figure 3: On-Resistance vs. Drain Current and Gate Voltage (Note E)

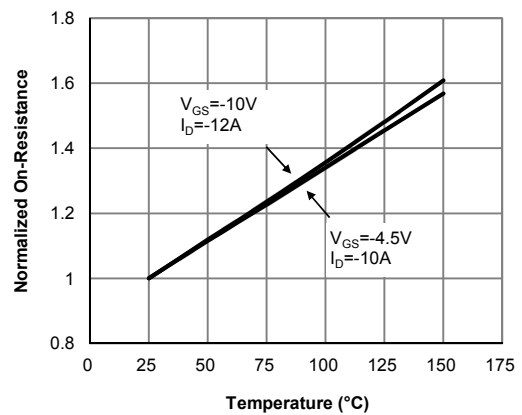

Figure 4: On-Resistance vs. Junction Temperature (Note E)

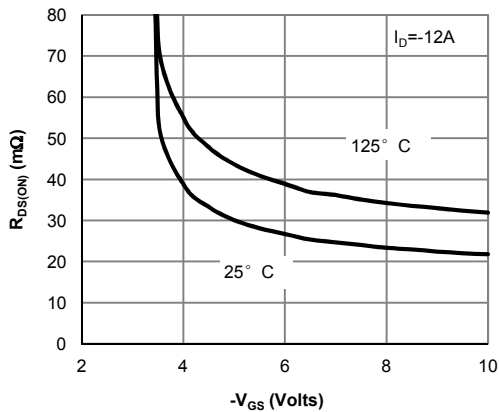

Figure 5: On-Resistance vs. Gate-Source Voltage (Note E)

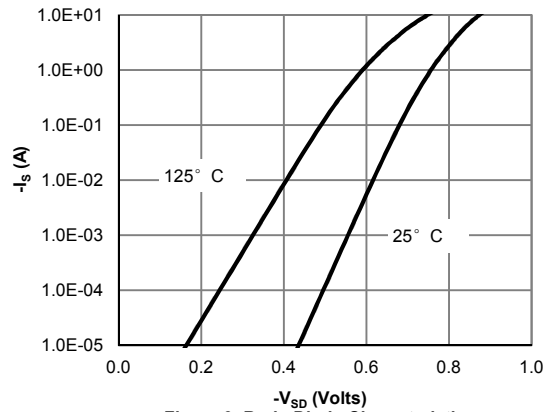

Figure 6: Body-Diode Characteristics (Note E)

TYPICAL ELECTRICAL AND THERMAL CHARACTERISTICS

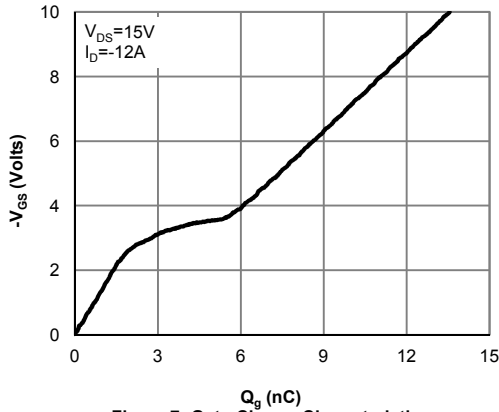

Figure 7: Gate-Charge Characteristics

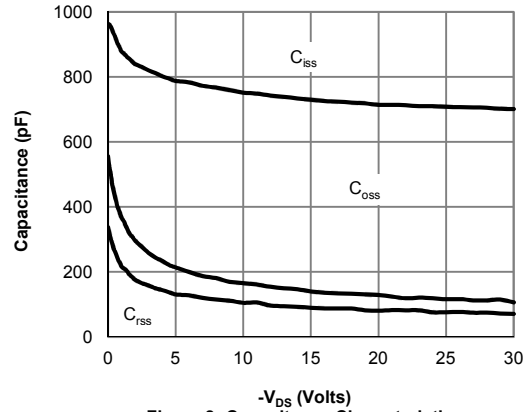

Figure 8: Capacitance Characteristics

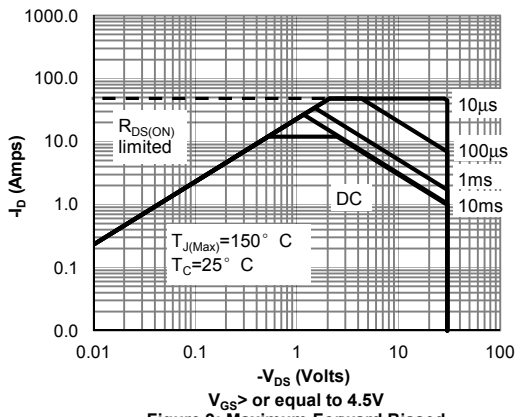

Figure 9: Maximum Forward Biased Safe Operating Area (Note F)

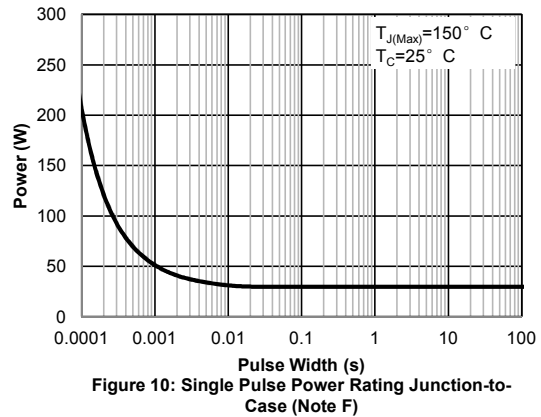

Figure 10: Single Pulse Power Rating Junction-to-Case (Note F)

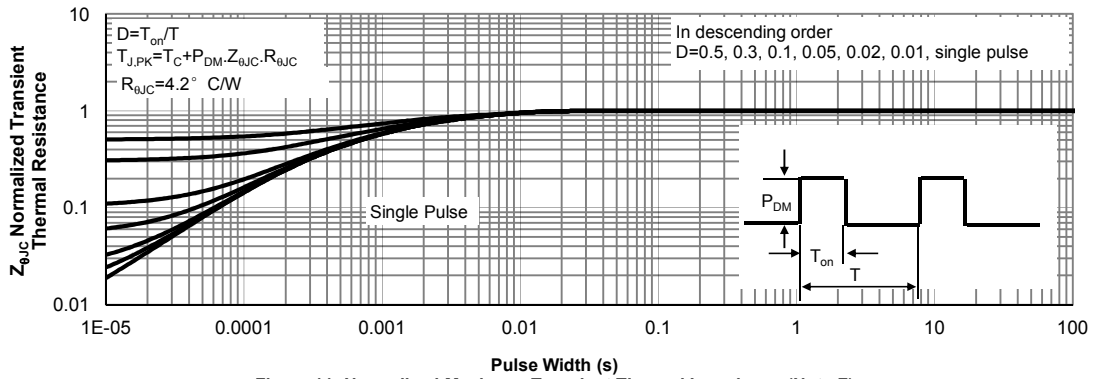

Figure 11: Normalized Maximum Transient Thermal Impedance (Note F)

TYPICAL ELECTRICAL AND THERMAL CHARACTERISTICS

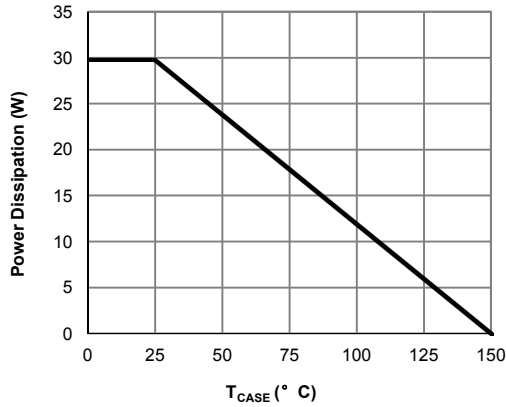

Figure 12: Power De-rating (Note F)

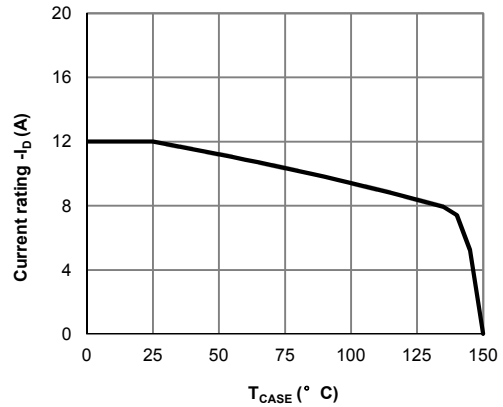

Figure 13: Current De-rating (Note F)

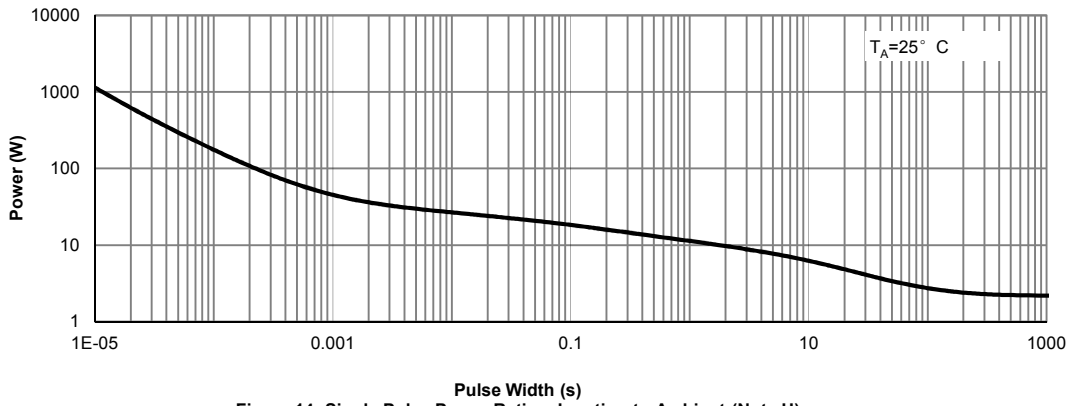

Figure 14: Single Pulse Power Rating Junction-to-Ambient (Note H)

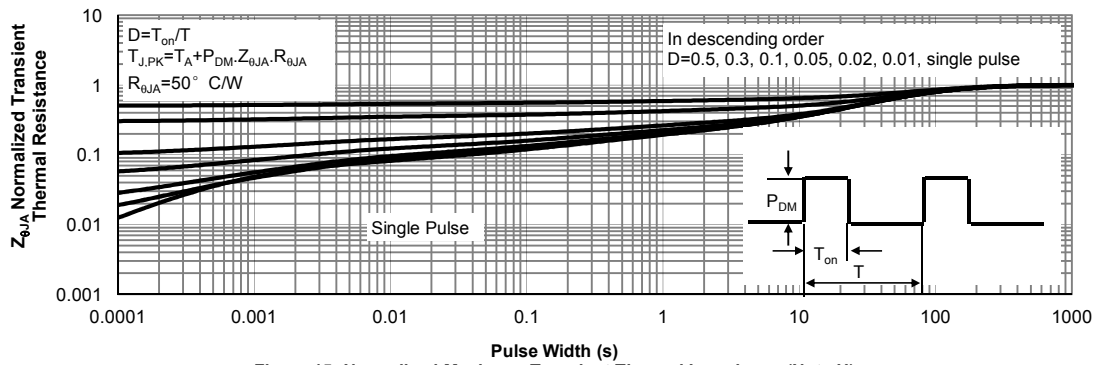

Figure 15: Normalized Maximum Transient Thermal Impedance (Note H)

Figure A: Gate Charge Test Circuit & Waveforms

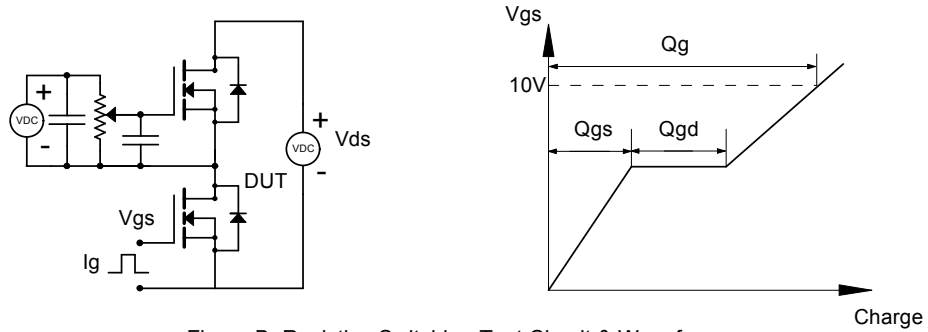

Figure B: Resistive Switching Test Circuit & Waveforms

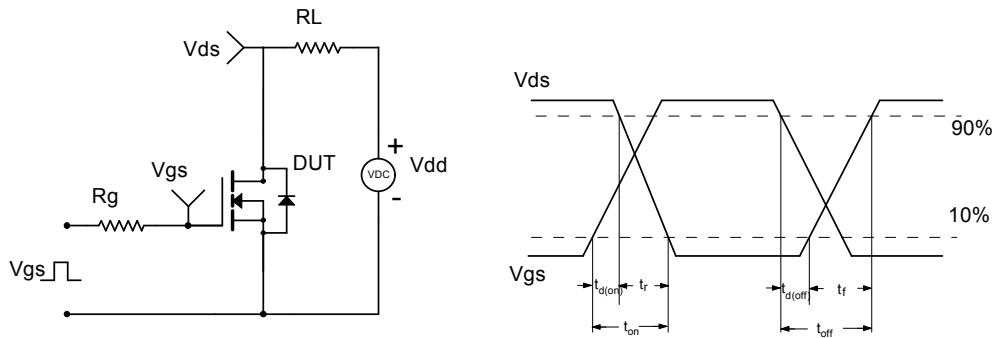

Figure C: Unclamped Inductive Switching (UIS) Test Circuit & Waveforms

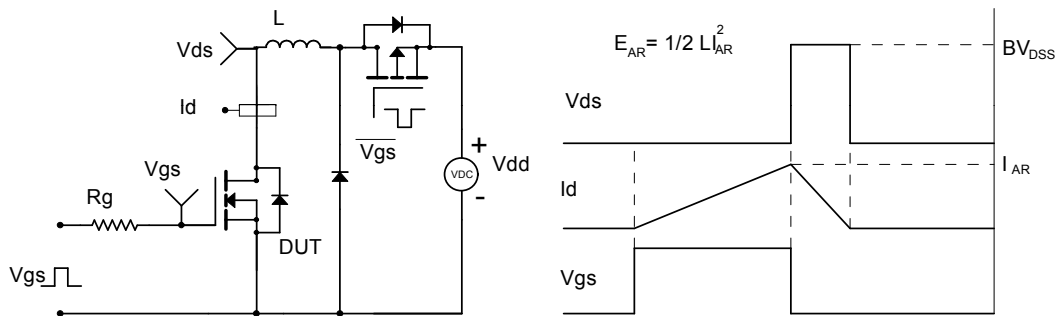
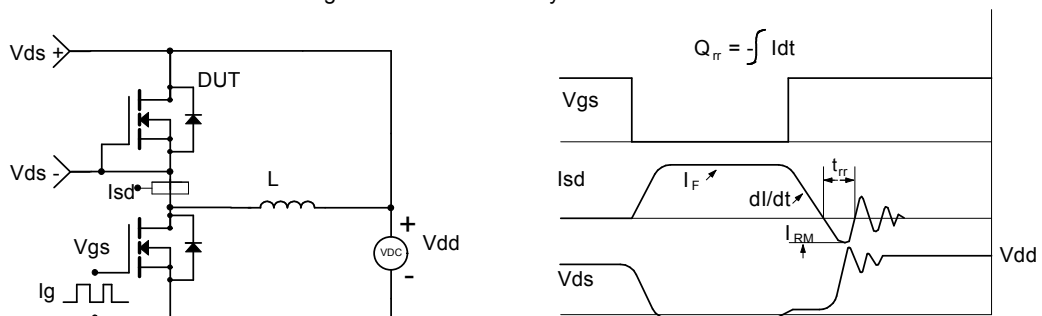
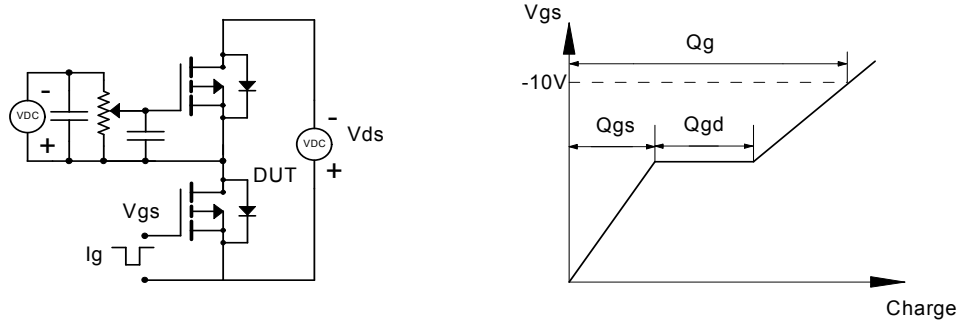

Figure D: Diode Recovery Test Circuit & Waveforms



Gate Charge Test Circuit & Waveform



Resistive Switching Test Circuit & Waveforms

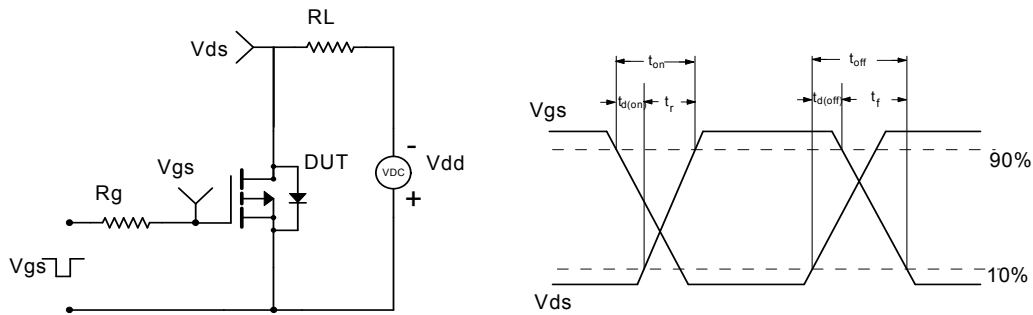

Unclamped Inductive Switching (UIS) Test Circuit & Waveforms

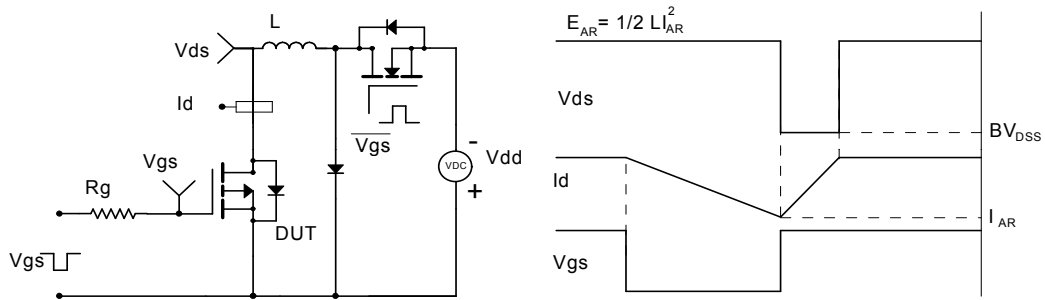

Diode Recovery Test Circuit & Waveforms

