



**General Description**

- Bottom source technology
- Very Low  $R_{DS(ON)}$  at  $V_{GS}=4.5V$
- Low Gate Charge
- High Current Capability
- RoHS 2.0 and Halogen-Free Compliant

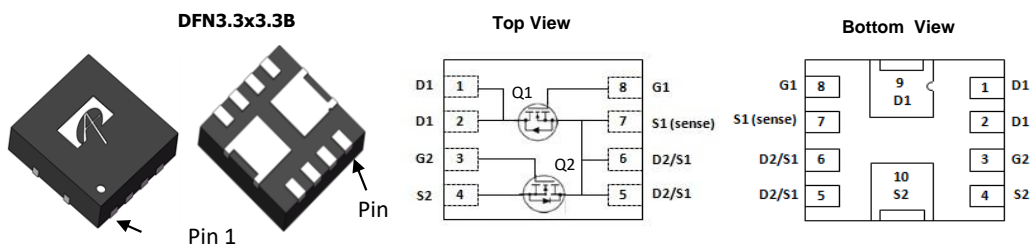
**Applications**

- Buck-boost Converters in Computing
- Point of Load Converter
- See Note I

**Product Summary**

	Q1	Q2
$V_{DS}$	30V	30V
$I_D$ (at $V_{GS}=10V$ )	50A	50A
$R_{DS(ON)}$ (at $V_{GS}=10V$ )	< 3.7m $\Omega$	< 4.7m $\Omega$
$R_{DS(ON)}$ (at $V_{GS}=4.5V$ )	< 4.7m $\Omega$	< 5.9m $\Omega$

100% UIS Tested  
100% Rg Tested



Orderable Part Number	Package Type	Form	Minimum Order Quantity
AONP36332	DFN3.3x3.3B	Tape & Reel	3000

**Absolute Maximum Ratings  $T_A=25^\circ C$  unless otherwise noted**

Parameter	Symbol	Max Q1	Max Q2	Units
Drain-Source Voltage	$V_{DS}$	30	30	V
Gate-Source Voltage	$V_{GS}$	$\pm 12$	$\pm 12$	V
Continuous Drain Current <sup>G</sup>	$I_D$	50	50	A
		$T_C=25^\circ C$	47	
Pulsed Drain Current <sup>C</sup>	$I_{DM}$	124	98	
Continuous Drain Current	$I_{DSM}$	24	20	A
		$T_A=25^\circ C$	19	
Avalanche Current <sup>C</sup>	$I_{AS}$	60	49	A
Avalanche energy $L=0.01mH$	$E_{AS}$	18	12	mJ
Power Dissipation <sup>B</sup>	$P_D$	33	30	W
		$T_C=25^\circ C$	13	
Power Dissipation <sup>A</sup>	$P_{DSM}$	3.4	3.1	W
		$T_A=25^\circ C$	2.2	
Junction and Storage Temperature	$T_J, T_{STG}$	-55 to 150		$^\circ C$

**Thermal Characteristics**

Parameter	Symbol	Typ Q1	Typ Q2	Max Q1	Max Q2	Units
Maximum Junction-to-Ambient <sup>A</sup>	$R_{\theta JA}$	30	33	36	40	$^\circ C/W$
Maximum Junction-to-Ambient <sup>A,D</sup>		52	55	63	66	$^\circ C/W$
Maximum Junction-to-Case	$R_{\theta JC}$	3	3.3	3.8	4.2	$^\circ C/W$

**Q1 Electrical Characteristics (T<sub>J</sub>=25°C unless otherwise noted)**

Symbol	Parameter	Conditions	Min	Typ	Max	Units
<b>STATIC PARAMETERS</b>						
BV <sub>DSS</sub>	Drain-Source Breakdown Voltage	I <sub>D</sub> =250μA, V <sub>GS</sub> =0V	30			V
I <sub>DSS</sub>	Zero Gate Voltage Drain Current	V <sub>DS</sub> =30V, V <sub>GS</sub> =0V T <sub>J</sub> =55°C			1 5	μA
I <sub>GSS</sub>	Gate-Body leakage current	V <sub>DS</sub> =0V, V <sub>GS</sub> =±12V			±100	nA
V <sub>GS(th)</sub>	Gate Threshold Voltage	V <sub>DS</sub> =V <sub>GS</sub> , I <sub>D</sub> =250μA	1.1	1.5	1.9	V
R <sub>DS(ON)</sub>	Static Drain-Source On-Resistance	V <sub>GS</sub> =10V, I <sub>D</sub> =20A T <sub>J</sub> =125°C		3.05	3.7	mΩ
		V <sub>GS</sub> =4.5V, I <sub>D</sub> =20A		4.2	5.1	
g <sub>FS</sub>	Forward Transconductance	V <sub>DS</sub> =5V, I <sub>D</sub> =20A		108		S
V <sub>SD</sub>	Diode Forward Voltage	I <sub>S</sub> =1A, V <sub>GS</sub> =0V		0.7	1	V
I <sub>S</sub>	Maximum Body-Diode Continuous Current				40	A
<b>DYNAMIC PARAMETERS</b>						
C <sub>iss</sub>	Input Capacitance	V <sub>GS</sub> =0V, V <sub>DS</sub> =15V, f=1MHz		1520		pF
C <sub>oss</sub>	Output Capacitance			330		pF
C <sub>riss</sub>	Reverse Transfer Capacitance			35		pF
R <sub>g</sub>	Gate resistance	f=1MHz	0.4	0.8	1.2	Ω
<b>SWITCHING PARAMETERS</b>						
Q <sub>g(10V)</sub>	Total Gate Charge	V <sub>GS</sub> =10V, V <sub>DS</sub> =15V, I <sub>D</sub> =20A		22	40	nC
Q <sub>g(4.5V)</sub>	Total Gate Charge			10	20	nC
Q <sub>gs</sub>	Gate Source Charge			4		nC
Q <sub>gd</sub>	Gate Drain Charge			2.2		nC
t <sub>D(on)</sub>	Turn-On DelayTime	V <sub>GS</sub> =10V, V <sub>DS</sub> =15V, R <sub>L</sub> =0.75Ω, R <sub>GEN</sub> =3Ω		6		ns
t <sub>r</sub>	Turn-On Rise Time			2.5		ns
t <sub>D(off)</sub>	Turn-Off DelayTime			22		ns
t <sub>f</sub>	Turn-Off Fall Time			2		ns
t <sub>rr</sub>	Body Diode Reverse Recovery Time	I <sub>F</sub> =20A, di/dt=500A/μs		12		ns
Q <sub>rr</sub>	Body Diode Reverse Recovery Charge	I <sub>F</sub> =20A, di/dt=500A/μs		21		nC

A. The value of R<sub>θJA</sub> is measured with the device mounted on 1in<sup>2</sup> FR-4 board with 2oz. Copper, in a still air environment with T<sub>A</sub>=25° C. The Power dissipation P<sub>DSM</sub> is based on R<sub>θJA</sub> ≤ 10s and the maximum allowed junction temperature of 150° C. The value in any given application depends on the user's specific board design.

B. The power dissipation P<sub>D</sub> is based on T<sub>J(MAX)</sub>=150° C, using junction-to-case thermal resistance, and is more useful in setting the upper dissipation limit for cases where additional heatsinking is used.

C. Single pulse width limited by junction temperature T<sub>J(MAX)</sub>=150° C.

D. The R<sub>θJA</sub> is the sum of the thermal impedance from junction to case R<sub>θJC</sub> and case to ambient.

E. The static characteristics in Figures 1 to 6 are obtained using <300μs pulses, duty cycle 0.5% max.

F. These curves are based on the junction-to-case thermal impedance which is measured with the device mounted to a large heatsink, assuming a maximum junction temperature of T<sub>J(MAX)</sub>=150° C. The SOA curve provides a single pulse rating.

G. The maximum current rating is package limited.

H. These tests are performed with the device mounted on 1 in<sup>2</sup> FR-4 board with 2oz. Copper, in a still air environment with T<sub>A</sub>=25° C.

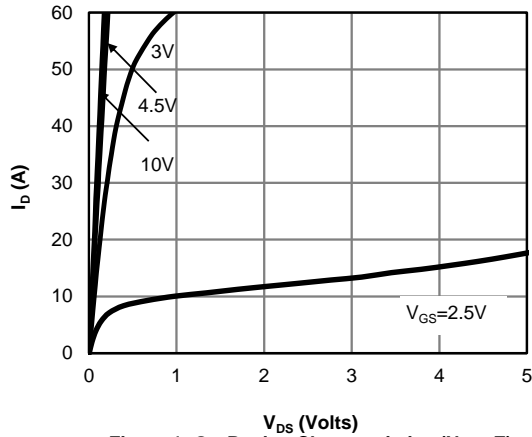
I. For application requiring slow >1ms turn-on/turn-off, please consult AOS FAE for proper product selection.

APPLICATIONS OR USES AS CRITICAL COMPONENTS IN LIFE SUPPORT DEVICES OR SYSTEMS ARE NOT AUTHORIZED. AOS DOES NOT ASSUME ANY LIABILITY ARISING OUT OF SUCH APPLICATIONS OR USES OF ITS PRODUCTS. AOS RESERVES THE RIGHT TO MAKE CHANGES TO PRODUCT SPECIFICATIONS WITHOUT NOTICE. IT IS THE RESPONSIBILITY OF THE CUSTOMER TO EVALUATE SUITABILITY OF THE PRODUCT FOR THEIR INTENDED APPLICATION. CUSTOMER SHALL COMPLY WITH APPLICABLE LEGAL REQUIREMENTS, INCLUDING ALL APPLICABLE EXPORT CONTROL RULES, REGULATIONS AND LIMITATIONS.

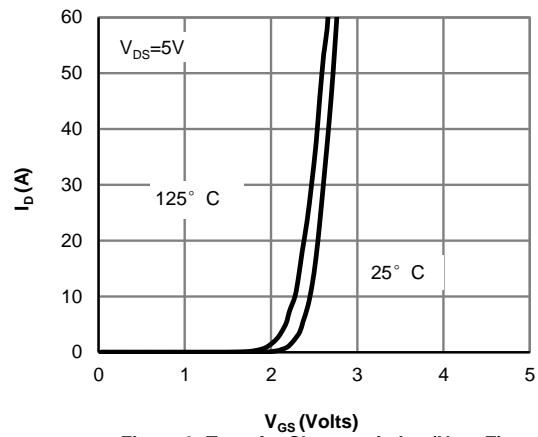
AOS' products are provided subject to AOS' terms and conditions of sale which are set forth at:

[http://www.aosmd.com/terms\\_and\\_conditions\\_of\\_sale](http://www.aosmd.com/terms_and_conditions_of_sale)

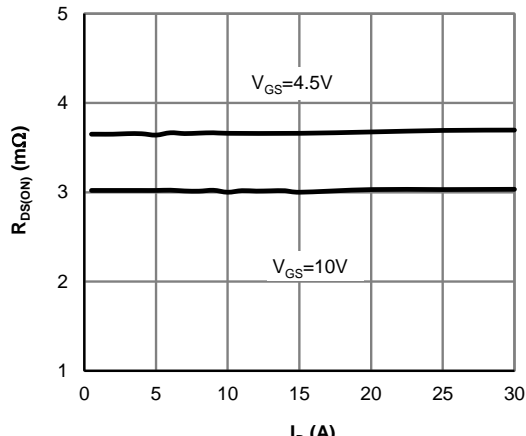
**TYPICAL ELECTRICAL AND THERMAL CHARACTERISTICS**



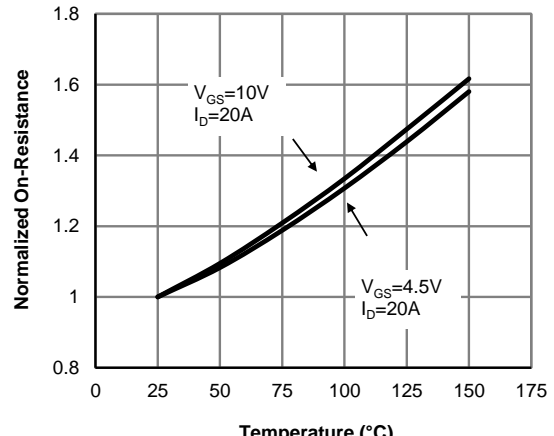
**Figure 1: On-Region Characteristics (Note E)**



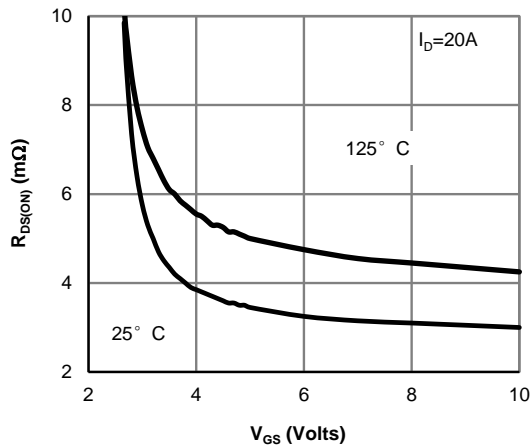
**Figure 2: Transfer Characteristics (Note E)**



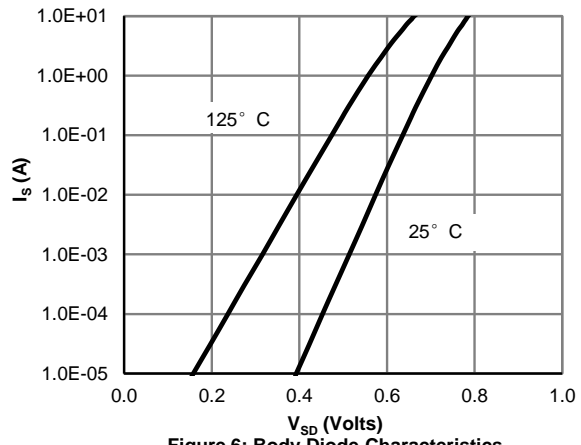
**Figure 3: On-Resistance vs. Drain Current and Gate Voltage (Note E)**



**Figure 4: On-Resistance vs. Junction Temperature (Note E)**

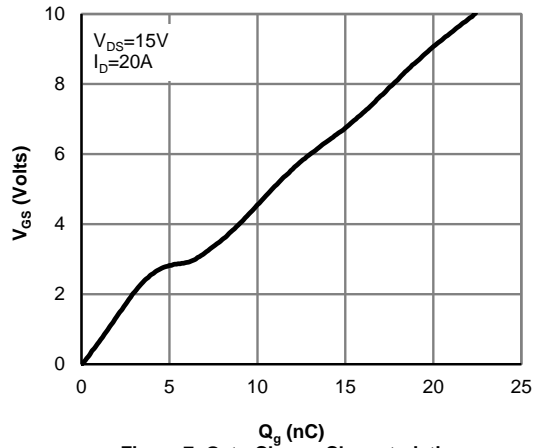


**Figure 5: On-Resistance vs. Gate-Source Voltage (Note E)**

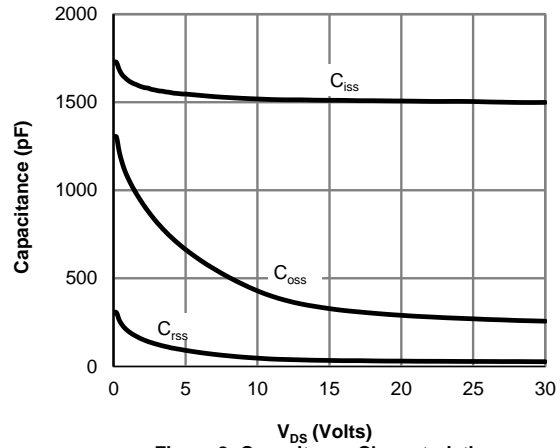


**Figure 6: Body-Diode Characteristics (Note E)**

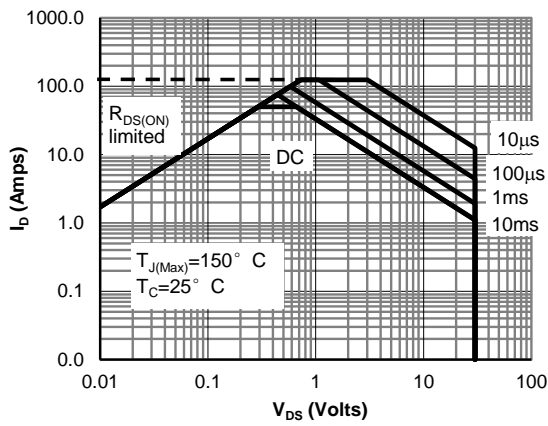
**TYPICAL ELECTRICAL AND THERMAL CHARACTERISTICS**



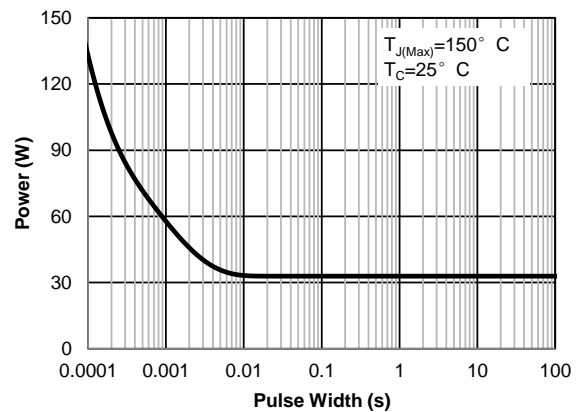
**Figure 7: Gate-Charge Characteristics**



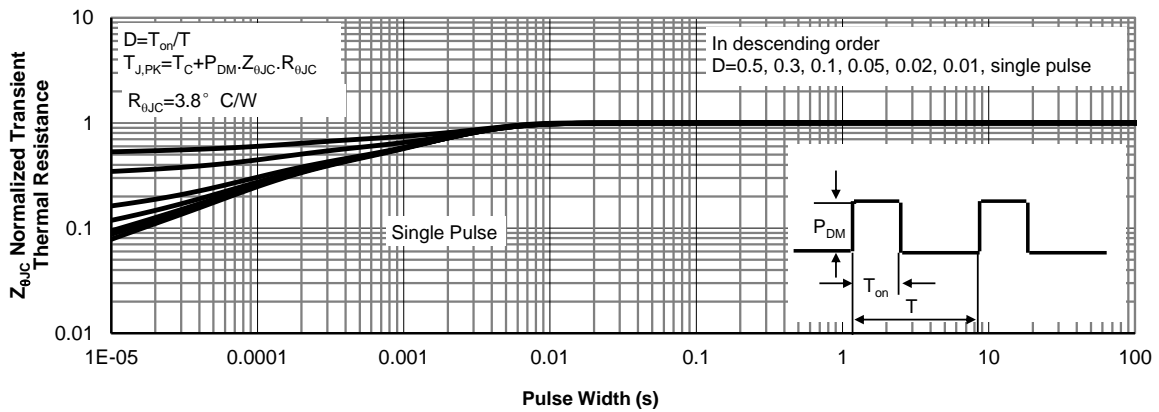
**Figure 8: Capacitance Characteristics**



**Figure 9: Maximum Forward Biased Safe Operating Area (Note F)**



**Figure 10: Single Pulse Power Rating Junction-to-Case (Note F)**



**Figure 11: Normalized Maximum Transient Thermal Impedance (Note F)**

**TYPICAL ELECTRICAL AND THERMAL CHARACTERISTICS**

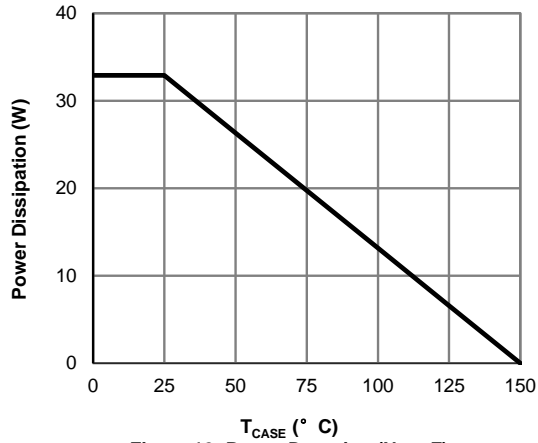


Figure 12: Power De-rating (Note F)

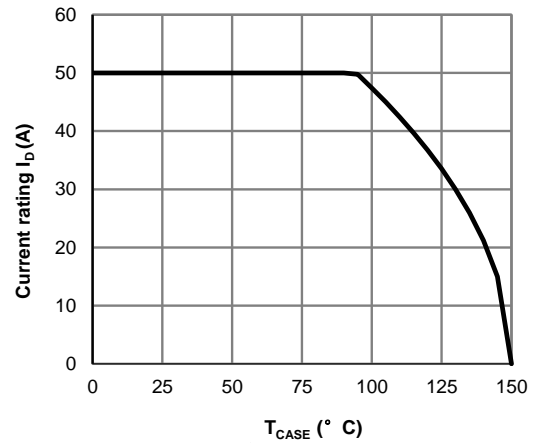


Figure 13: Current De-rating (Note F)

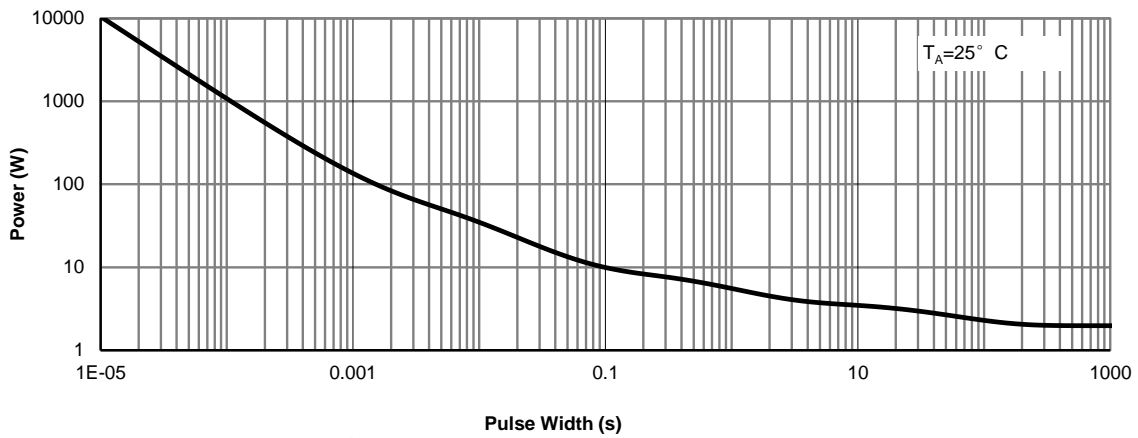


Figure 14: Single Pulse Power Rating Junction-to-Ambient (Note H)

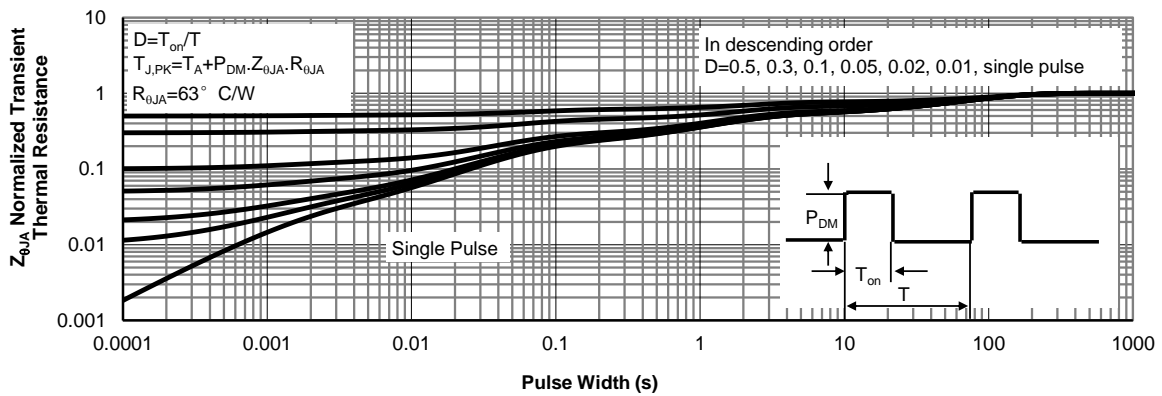


Figure 15: Normalized Maximum Transient Thermal Impedance (Note H)

**Q2 Electrical Characteristics (T<sub>J</sub>=25°C unless otherwise noted)**

Symbol	Parameter	Conditions	Min	Typ	Max	Units
<b>STATIC PARAMETERS</b>						
BV <sub>DSS</sub>	Drain-Source Breakdown Voltage	I <sub>D</sub> =250μA, V <sub>GS</sub> =0V	30			V
I <sub>DSS</sub>	Zero Gate Voltage Drain Current	V <sub>DS</sub> =30V, V <sub>GS</sub> =0V T <sub>J</sub> =55°C			1 5	μA
I <sub>GSS</sub>	Gate-Body leakage current	V <sub>DS</sub> =0V, V <sub>GS</sub> =±12V			±10	μA
V <sub>GS(th)</sub>	Gate Threshold Voltage	V <sub>DS</sub> =V <sub>GS</sub> , I <sub>D</sub> =250μA	1.1	1.5	1.9	V
R <sub>DS(on)</sub>	Static Drain-Source On-Resistance	V <sub>GS</sub> =10V, I <sub>D</sub> =20A T <sub>J</sub> =125°C		3.9	4.7	mΩ
		V <sub>GS</sub> =4.5V, I <sub>D</sub> =20A		4.7	5.9	
g <sub>FS</sub>	Forward Transconductance	V <sub>DS</sub> =5V, I <sub>D</sub> =20A		125		S
V <sub>SD</sub>	Diode Forward Voltage	I <sub>S</sub> =1A, V <sub>GS</sub> =0V		0.7	1	V
I <sub>S</sub>	Maximum Body-Diode Continuous Current				40	A
<b>DYNAMIC PARAMETERS</b>						
C <sub>iss</sub>	Input Capacitance	V <sub>GS</sub> =0V, V <sub>DS</sub> =15V, f=1MHz		1220		pF
C <sub>oss</sub>	Output Capacitance			260		pF
C <sub>riss</sub>	Reverse Transfer Capacitance			30		pF
R <sub>g</sub>	Gate resistance	f=1MHz	0.9	1.9	2.9	Ω
<b>SWITCHING PARAMETERS</b>						
Q <sub>g(10V)</sub>	Total Gate Charge	V <sub>GS</sub> =10V, V <sub>DS</sub> =15V, I <sub>D</sub> =20A		17	30	nC
Q <sub>g(4.5V)</sub>	Total Gate Charge			7.5	16	nC
Q <sub>gs</sub>	Gate Source Charge			3.2		nC
Q <sub>gd</sub>	Gate Drain Charge			1		nC
t <sub>D(on)</sub>	Turn-On Delay Time	V <sub>GS</sub> =10V, V <sub>DS</sub> =15V, R <sub>L</sub> =0.75Ω, R <sub>GEN</sub> =3Ω		5		ns
t <sub>r</sub>	Turn-On Rise Time			18		ns
t <sub>D(off)</sub>	Turn-Off Delay Time			23		ns
t <sub>f</sub>	Turn-Off Fall Time			2		ns
t <sub>rr</sub>	Body Diode Reverse Recovery Time	I <sub>F</sub> =20A, di/dt=500A/μs		10		ns
Q <sub>rr</sub>	Body Diode Reverse Recovery Charge	I <sub>F</sub> =20A, di/dt=500A/μs		15		nC

A. The value of R<sub>θJA</sub> is measured with the device mounted on 1in<sup>2</sup> FR-4 board with 2oz. Copper, in a still air environment with T<sub>A</sub>=25° C. The Power dissipation P<sub>DSM</sub> is based on R<sub>θJA</sub> ≤ 10s and the maximum allowed junction temperature of 150° C. The value in any given application depends on the user's specific board design.

B. The power dissipation P<sub>D</sub> is based on T<sub>J(MAX)</sub>=150° C, using junction-to-case thermal resistance, and is more useful in setting the upper dissipation limit for cases where additional heatsinking is used.

C. Single pulse width limited by junction temperature T<sub>J(MAX)</sub>=150° C.

D. The R<sub>θJA</sub> is the sum of the thermal impedance from junction to case R<sub>θJC</sub> and case to ambient.

E. The static characteristics in Figures 1 to 6 are obtained using <300μs pulses, duty cycle 0.5% max.

F. These curves are based on the junction-to-case thermal impedance which is measured with the device mounted to a large heatsink, assuming a maximum junction temperature of T<sub>J(MAX)</sub>=150° C. The SOA curve provides a single pulse rating.

G. The maximum current rating is package limited.

H. These tests are performed with the device mounted on 1 in<sup>2</sup> FR-4 board with 2oz. Copper, in a still air environment with T<sub>A</sub>=25° C.

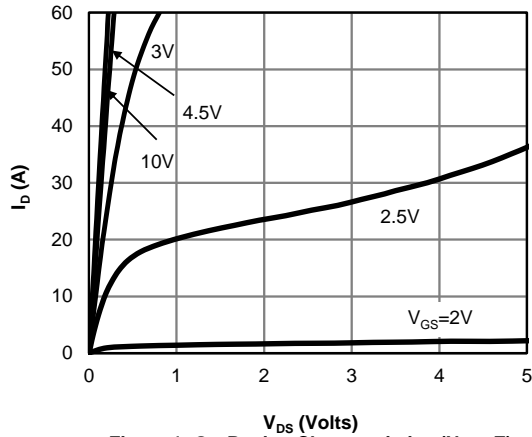
I. For application requiring slow >1ms turn-on/turn-off, please consult AOS FAE for proper product selection.

APPLICATIONS OR USES AS CRITICAL COMPONENTS IN LIFE SUPPORT DEVICES OR SYSTEMS ARE NOT AUTHORIZED. AOS DOES NOT ASSUME ANY LIABILITY ARISING OUT OF SUCH APPLICATIONS OR USES OF ITS PRODUCTS. AOS RESERVES THE RIGHT TO MAKE CHANGES TO PRODUCT SPECIFICATIONS WITHOUT NOTICE. IT IS THE RESPONSIBILITY OF THE CUSTOMER TO EVALUATE SUITABILITY OF THE PRODUCT FOR THEIR INTENDED APPLICATION. CUSTOMER SHALL COMPLY WITH APPLICABLE LEGAL REQUIREMENTS, INCLUDING ALL APPLICABLE EXPORT CONTROL RULES, REGULATIONS AND LIMITATIONS.

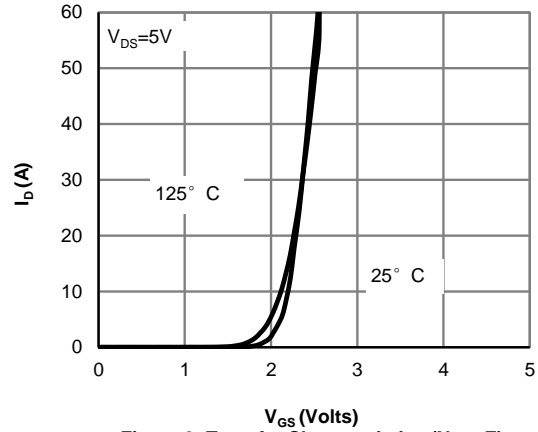
AOS' products are provided subject to AOS' terms and conditions of sale which are set forth at:

[http://www.aosmd.com/terms\\_and\\_conditions\\_of\\_sale](http://www.aosmd.com/terms_and_conditions_of_sale)

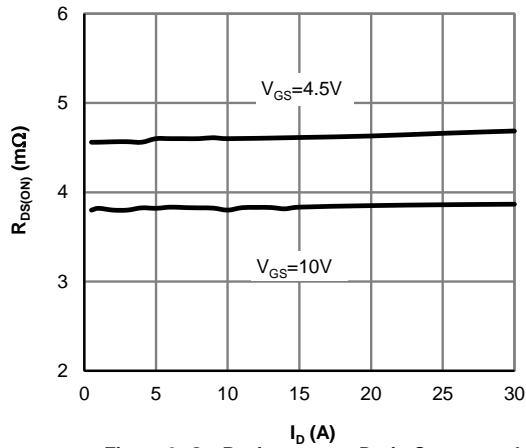
**TYPICAL ELECTRICAL AND THERMAL CHARACTERISTICS**



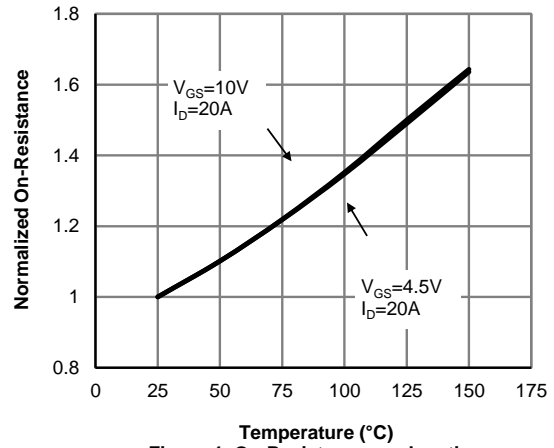
**Figure 1: On-Region Characteristics (Note E)**



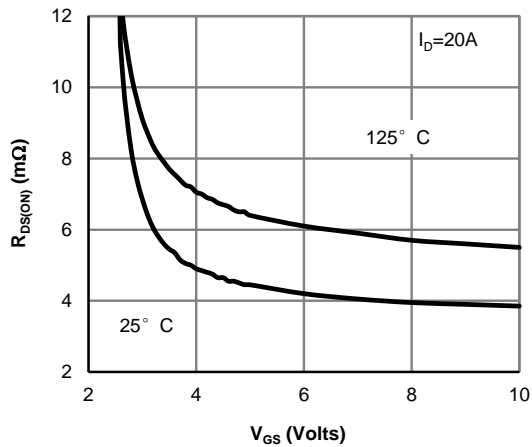
**Figure 2: Transfer Characteristics (Note E)**



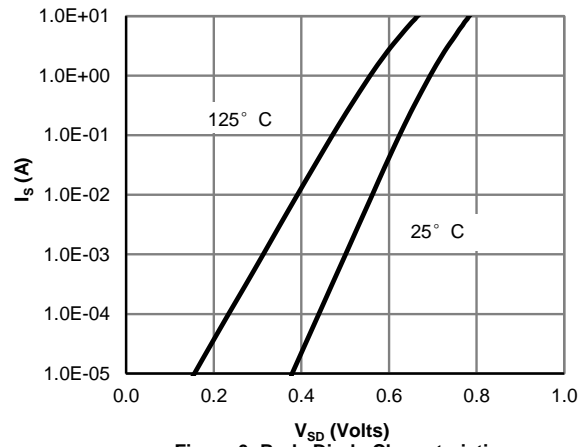
**Figure 3: On-Resistance vs. Drain Current and Gate Voltage (Note E)**



**Figure 4: On-Resistance vs. Junction Temperature (Note E)**

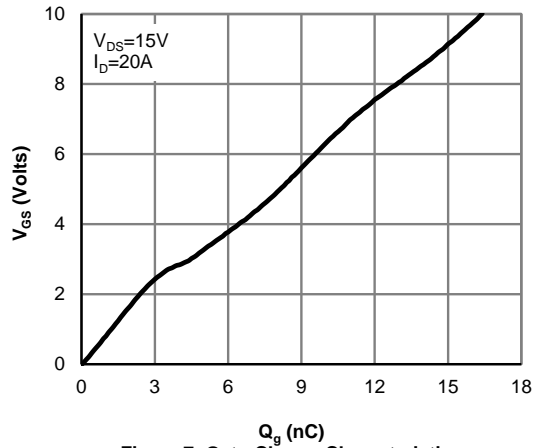


**Figure 5: On-Resistance vs. Gate-Source Voltage (Note E)**

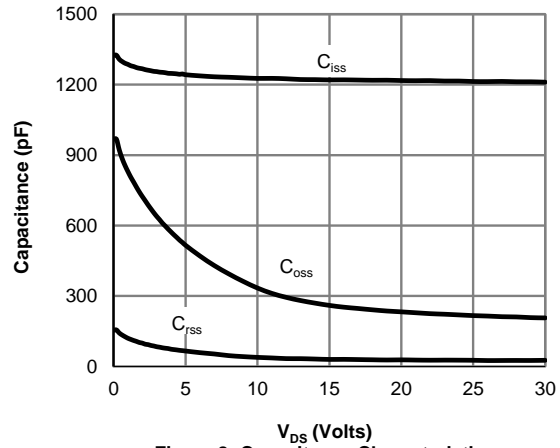


**Figure 6: Body-Diode Characteristics (Note E)**

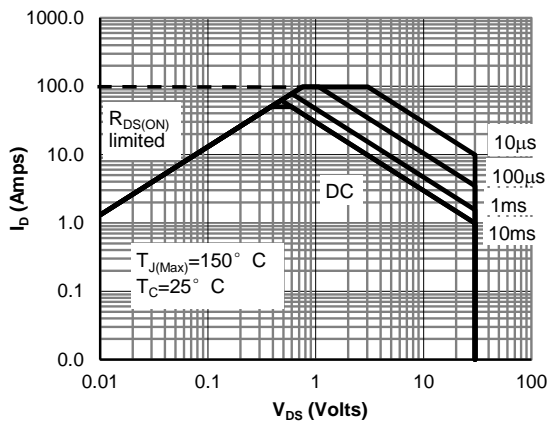
**TYPICAL ELECTRICAL AND THERMAL CHARACTERISTICS**



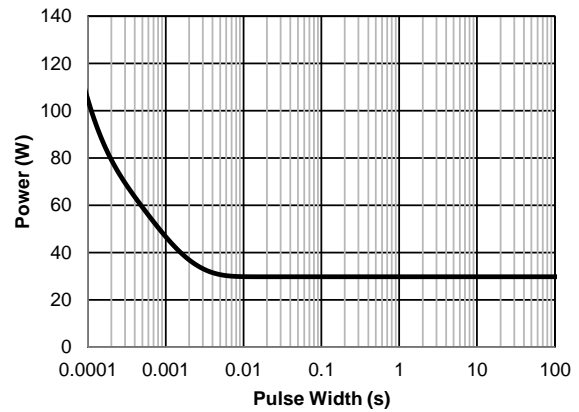
**Figure 7: Gate-Charge Characteristics**



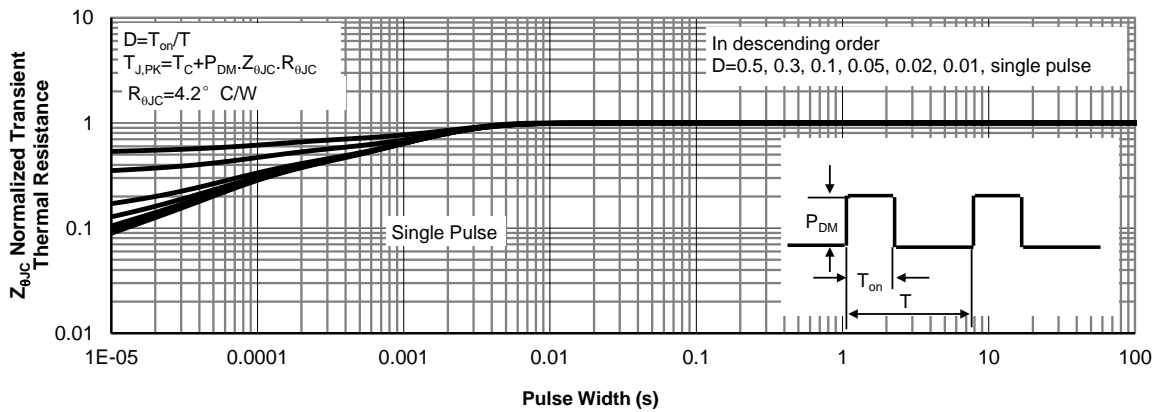
**Figure 8: Capacitance Characteristics**



**Figure 9: Maximum Forward Biased Safe Operating Area (Note F)**



**Figure 10: Single Pulse Power Rating Junction-to-Case (Note F)**



**Figure 11: Normalized Maximum Transient Thermal Impedance (Note F)**



**TYPICAL ELECTRICAL AND THERMAL CHARACTERISTICS**

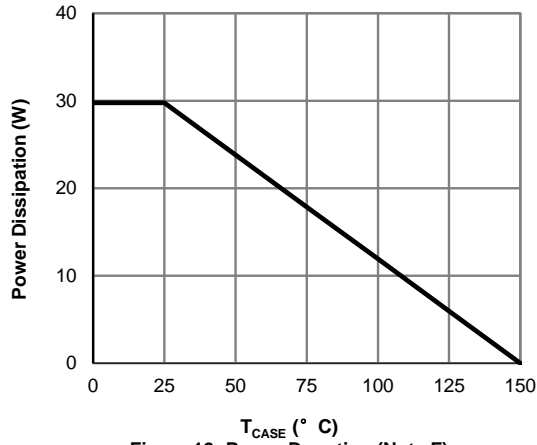


Figure 12: Power De-rating (Note F)

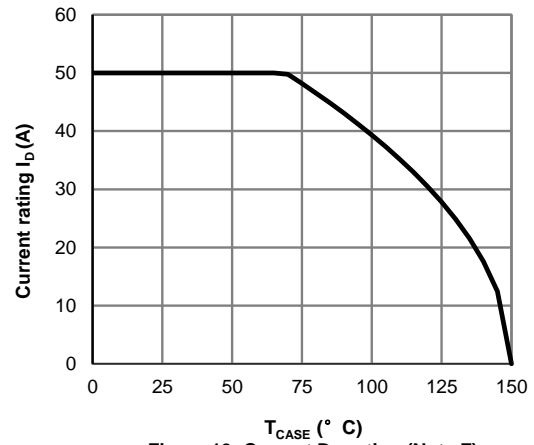


Figure 13: Current De-rating (Note F)

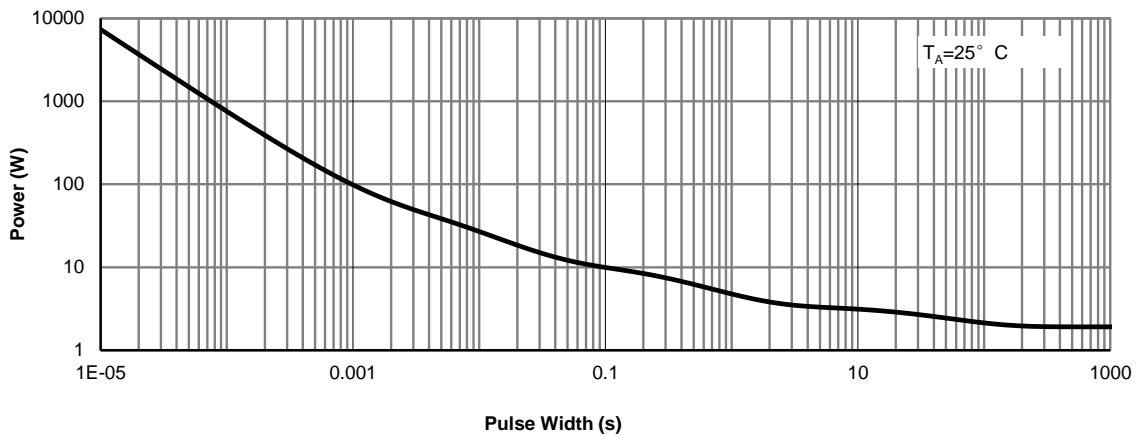


Figure 14: Single Pulse Power Rating Junction-to-Ambient (Note H)

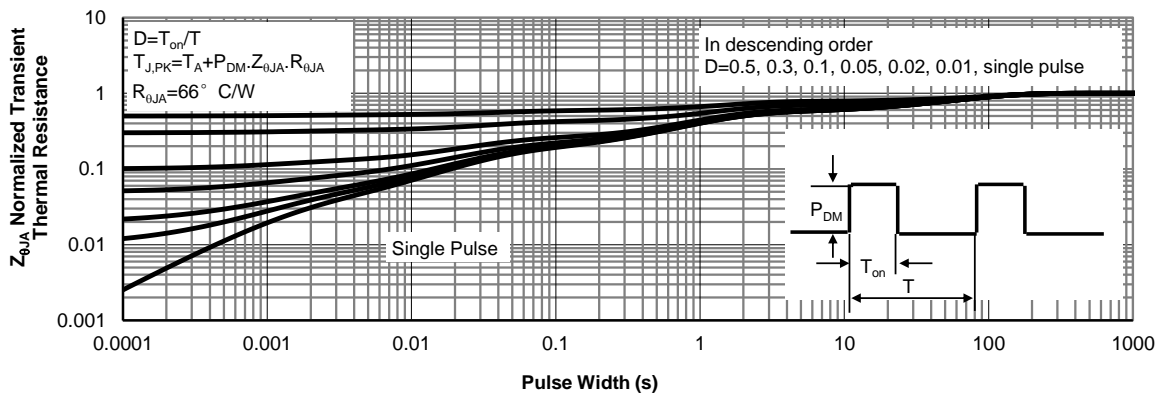


Figure 15: Normalized Maximum Transient Thermal Impedance (Note H)

Figure A: Gate Charge Test Circuit & Waveforms

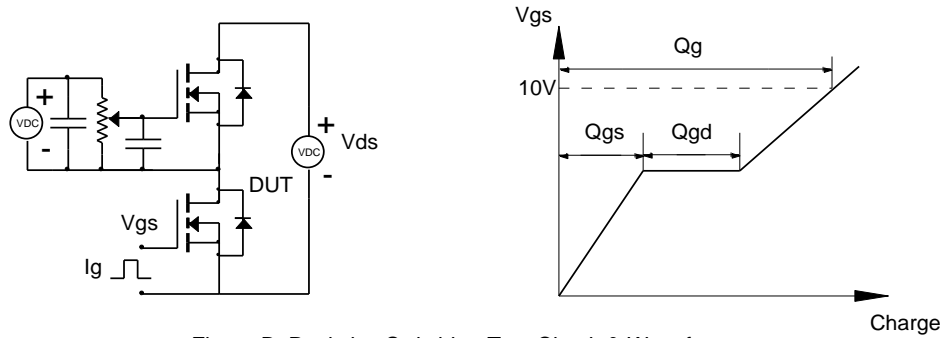


Figure B: Resistive Switching Test Circuit & Waveforms

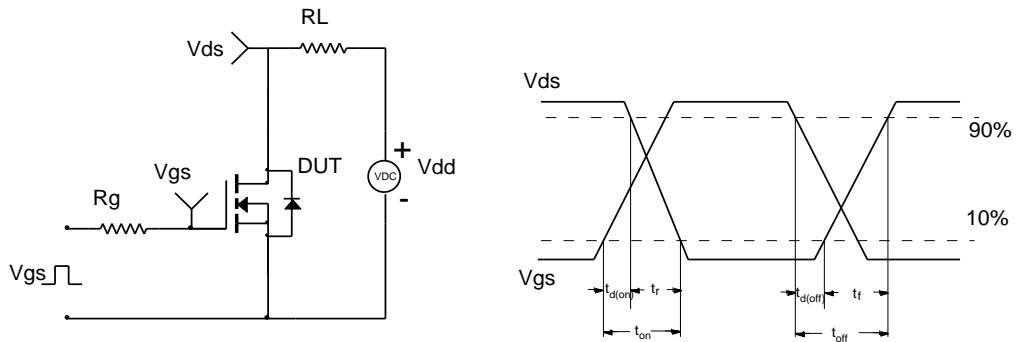


Figure C: Unclamped Inductive Switching (UIS) Test Circuit & Waveforms

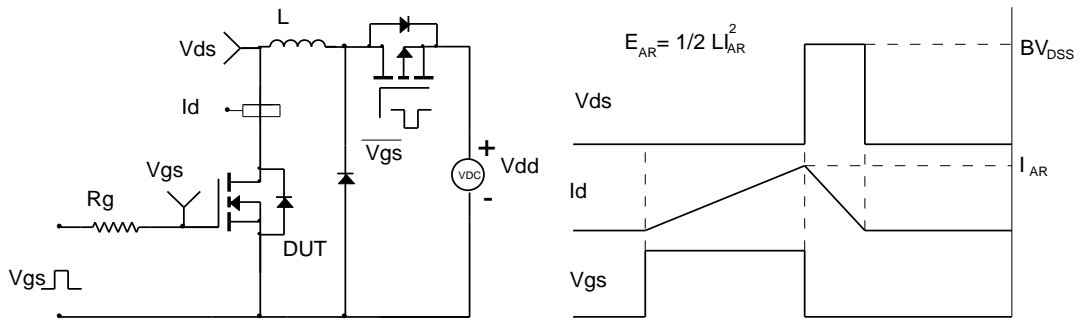


Figure D: Diode Recovery Test Circuit & Waveforms

