

**General Description**

- Proprietary  $\alpha$ MOS5™ technology
- Low  $R_{DS(ON)}$
- Optimized switching parameters for better EMI performance
- Enhanced body diode for robustness and fast reverse recovery

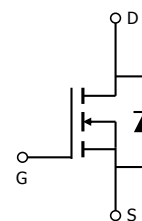
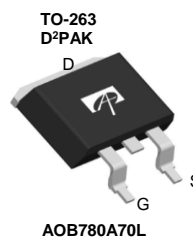
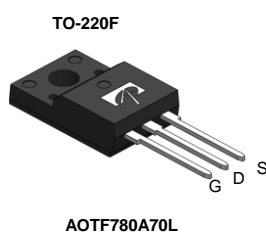
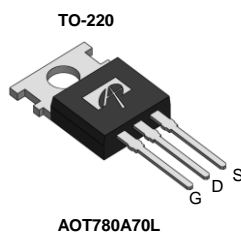
**Applications**

- PFC and PWM stages (Flyback, LLC) of Adapter, PC Silverbox, Server, Gaming Power Supply, Industrial, TV, Lighting

**Product Summary**

|                      |                 |
|----------------------|-----------------|
| $V_{DS} @ T_{j,max}$ | 800V            |
| $I_{DM}$             | 28A             |
| $R_{DS(ON),max}$     | < 0.78 $\Omega$ |
| $Q_{g,typ}$          | 11.5nC          |
| $E_{oss} @ 400V$     | 1.4 $\mu$ J     |

100% UIS Tested  
 100%  $R_g$  Tested



| Orderable Part Number | Package Type | Form      | Minimum Order Quantity |
|-----------------------|--------------|-----------|------------------------|
| AOTF780A70L           | TO220F       | Tube      | 1000                   |
| AOT780A70L            | TO220        | Tube      | 1000                   |
| AOB780A70L            | TO263        | Tape&Reel | 800                    |

**Absolute Maximum Ratings  $T_A=25^\circ\text{C}$  unless otherwise noted**

| Parameter  | Symbol         | AOT(B)780A70L                   | AOTF780A70L | Units            |
|--|----------------|---------------------------------|-------------|------------------|
| Drain-Source Voltage   | $V_{DS}$       | 700                             |             | V                |
| Gate-Source Voltage  | $V_{GS}$       | $\pm 20$                        |             | V                |
| Gate-Source Voltage (dynamic) AC( $f > 1\text{Hz}$ )                         | $V_{GS}$       | $\pm 30$                        |             | V                |
| Continuous Drain Current   | $I_D$          | $T_C=25^\circ\text{C}$          | 7           | 7*               |
|  |                | $T_C=100^\circ\text{C}$         | 4.5         | 4.5*             |
| Pulsed Drain Current <sup>C</sup>  | $I_{DM}$       | 28                              |             | A                |
| Avalanche Current <sup>C</sup> $L=1\text{mH}$                                | $I_{AR}$       | 1.7                             |             | A                |
| Repetitive avalanche energy <sup>C</sup>                                     | $E_{AR}$       | 1.5                             |             | mJ               |
| Single pulsed avalanche energy <sup>G</sup>                                  | $E_{AS}$       | 11                              |             | mJ               |
| MOSFET $dv/dt$ ruggedness  | $dv/dt$        | 100                             |             | V/ns             |
| Peak diode recovery $dv/dt$  |                | 20                              |             |                  |
| Power Dissipation <sup>B</sup>   | $P_D$          | $T_C=25^\circ\text{C}$          | 89          | 25               |
|  |                | Derate above $25^\circ\text{C}$ | 0.7         | 0.2              |
| Junction and Storage Temperature Range                                       | $T_J, T_{STG}$ | -55 to 150                      |             | $^\circ\text{C}$ |
| Maximum lead temperature for soldering purpose, 1/8" from case for 5 seconds | $T_L$          | 300                             |             | $^\circ\text{C}$ |

**Thermal Characteristics**

| Parameter                                  | Symbol          | AOT(B)780A70L | AOTF780A70L | Units              |
|--|-----------------|---------------|-------------|--------------------|
| Maximum Junction-to-Ambient <sup>A,D</sup> | $R_{\theta JA}$ | 65            | 65          | $^\circ\text{C/W}$ |
| Maximum Case-to-sink <sup>A</sup>          | $R_{\theta CS}$ | 0.5           | --          | $^\circ\text{C/W}$ |
| Maximum Junction-to-Case                   | $R_{\theta JC}$ | 1.4           | 5.0         | $^\circ\text{C/W}$ |

\* Drain current limited by maximum junction temperature.

**Electrical Characteristics (T<sub>J</sub>=25°C unless otherwise noted)**

| Symbol                             | Parameter   | Conditions  | Min | Typ  | Max  | Units |    |
|------------------------------------|---|---|-----|------|------|-------|----|
| <b>STATIC PARAMETERS</b>           |   |   |     |      |      |       |    |
| BV <sub>DSS</sub>                  | Drain-Source Breakdown Voltage                            | I <sub>D</sub> =250μA, V <sub>GS</sub> =0V, T <sub>J</sub> =25°C                      | 700 |      |      | V     |    |
|                                    |   | I <sub>D</sub> =250μA, V <sub>GS</sub> =0V, T <sub>J</sub> =150°C                     |     | 800  |      |       |    |
| BV <sub>DSS</sub> /ΔT <sub>J</sub> | Breakdown Voltage Temperature Coefficient                 | I <sub>D</sub> =250μA, V <sub>GS</sub> =0V  |     | 0.56 |      | V/°C  |    |
| I <sub>DSS</sub>                   | Zero Gate Voltage Drain Current                           | V <sub>DS</sub> =700V, V <sub>GS</sub> =0V  |     |      | 1    | μA    |    |
|                                    |   | V <sub>DS</sub> =560V, T <sub>J</sub> =125°C  |     |      | 10   |       |    |
| I <sub>GSS</sub>                   | Gate-Body leakage current                                 | V <sub>DS</sub> =0V, V <sub>GS</sub> =±20V  |     |      | ±100 | nA    |    |
| V <sub>GS(th)</sub>                | Gate Threshold Voltage                                    | V <sub>DS</sub> =5V, I <sub>D</sub> =250μA  | 2.9 | 3.5  | 4.1  | V     |    |
| R <sub>DS(ON)</sub>                | Static Drain-Source On-Resistance                         | V <sub>GS</sub> =10V, I <sub>D</sub> =1.4A  |     | 0.7  | 0.78 | Ω     |    |
| g <sub>FS</sub>                    | Forward Transconductance                                  | V <sub>DS</sub> =10V, I <sub>D</sub> =1.4A  |     | 3    |      | S     |    |
| V <sub>SD</sub>                    | Diode Forward Voltage                                     | I <sub>S</sub> =1.4A, V <sub>GS</sub> =0V   |     | 0.8  | 1.2  | V     |    |
| I <sub>S</sub>                     | Maximum Body-Diode Continuous Current                     |   |     |      | 7    | A     |    |
| I <sub>SM</sub>                    | Maximum Body-Diode Pulsed Current <sup>C</sup>            |   |     |      | 28   | A     |    |
| <b>DYNAMIC PARAMETERS</b>          |   |   |     |      |      |       |    |
| C <sub>iss</sub>                   | Input Capacitance   | V <sub>GS</sub> =0V, V <sub>DS</sub> =100V, f=1MHz                                    |     | 675  |      | pF    |    |
| C <sub>oss</sub>                   | Output Capacitance  |   |     |      | 18   |       | pF |
| C <sub>o(er)</sub>                 | Effective output capacitance, energy related <sup>H</sup> | V <sub>GS</sub> =0V, V <sub>DS</sub> =0 to 400V, f=1MHz                               |     | 16.5 |      | pF    |    |
| C <sub>o(tr)</sub>                 | Effective output capacitance, time related <sup>I</sup>   |   |     |      | 72   |       | pF |
| C <sub>rss</sub>                   | Reverse Transfer Capacitance                              | V <sub>GS</sub> =0V, V <sub>DS</sub> =100V, f=1MHz                                    |     | 1.8  |      | pF    |    |
| R <sub>g</sub>                     | Gate resistance   | f=1MHz  |     | 3.1  |      | Ω     |    |
| <b>SWITCHING PARAMETERS</b>        |   |   |     |      |      |       |    |
| Q <sub>g</sub>                     | Total Gate Charge   | V <sub>GS</sub> =10V, V <sub>DS</sub> =480V, I <sub>D</sub> =3.5A                     |     | 11.5 |      | nC    |    |
| Q <sub>gs</sub>                    | Gate Source Charge  |   |     |      | 4.8  |       | nC |
| Q <sub>gd</sub>                    | Gate Drain Charge   |   |     |      | 2.8  |       | nC |
| T <sub>d(on)</sub>                 | Turn-On DelayTime   | V <sub>GS</sub> =10V, V <sub>DS</sub> =400V, I <sub>D</sub> =3.5A, R <sub>G</sub> =5Ω |     | 18   |      | ns    |    |
| T <sub>r</sub>                     | Turn-On Rise Time   |   |     |      | 9    |       | ns |
| T <sub>d(off)</sub>                | Turn-Off DelayTime  |   |     |      | 30   |       | ns |
| T <sub>f</sub>                     | Turn-Off Fall Time  |   |     |      | 12   |       | ns |
| T <sub>rr</sub>                    | Body Diode Reverse Recovery Time                          |   |     |      | 230  |       | ns |
| I <sub>rm</sub>                    | Peak Reverse Recovery Current                             | I <sub>F</sub> =3.5A, di/dt=100A/μs, V <sub>DS</sub> =400V                            |     |      | 16.5 | A     |    |
| Q <sub>rr</sub>                    | Body Diode Reverse Recovery Charge                        |   |     |      | 2.5  | μC    |    |

A. The value of R<sub>θJA</sub> is measured with the device in a still air environment with T<sub>A</sub>=25° C.

B. The power dissipation P<sub>D</sub> is based on T<sub>J(MAX)</sub>=150° C, using junction-to-case thermal resistance, and is more useful in setting the upper dissipation limit for cases where additional heatsinking is used.

C. Repetitive rating, pulse width limited by junction temperature T<sub>J(MAX)</sub>=150° C, Ratings are based on low frequency and duty cycles to keep initial T<sub>J</sub>=25° C.

D. The R<sub>θJA</sub> is the sum of the thermal impedance from junction to case R<sub>θJC</sub> and case to ambient.

E. The static characteristics in Figures 1 to 6 are obtained using <300μs pulses, duty cycle 0.5% max.

F. These curves are based on the junction-to-case thermal impedance which is measured with the device mounted to a large heatsink, assuming a maximum junction temperature of T<sub>J(MAX)</sub>=150° C. The SOA curve provides a single pulse rating.

G. L=60mH, I<sub>AS</sub>=0.6A, R<sub>G</sub>=25Ω, Starting T<sub>J</sub>=25° C.

H. C<sub>o(er)</sub> is a fixed capacitance that gives the same stored energy as C<sub>oss</sub> while V<sub>DS</sub> is rising from 0 to 80% V<sub>(BR)DSS</sub>.

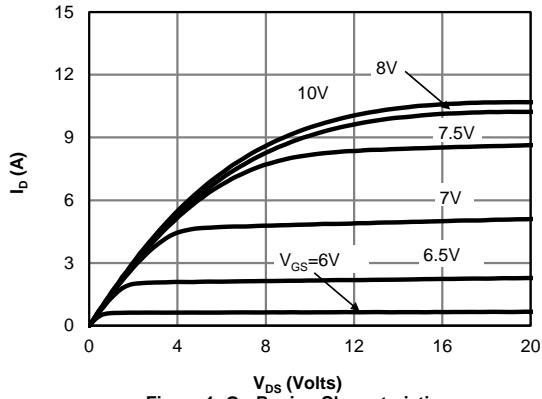
I. C<sub>o(tr)</sub> is a fixed capacitance that gives the same charging time as C<sub>oss</sub> while V<sub>DS</sub> is rising from 0 to 80% V<sub>(BR)DSS</sub>.

APPLICATIONS OR USES AS CRITICAL COMPONENTS IN LIFE SUPPORT DEVICES OR SYSTEMS ARE NOT AUTHORIZED. AOS DOES NOT ASSUME ANY LIABILITY ARISING OUT OF SUCH APPLICATIONS OR USES OF ITS PRODUCTS. AOS RESERVES THE RIGHT TO MAKE CHANGES TO PRODUCT SPECIFICATIONS WITHOUT NOTICE. IT IS THE RESPONSIBILITY OF THE CUSTOMER TO EVALUATE SUITABILITY OF THE PRODUCT FOR THEIR INTENDED APPLICATION. CUSTOMER SHALL COMPLY WITH APPLICABLE LEGAL REQUIREMENTS, INCLUDING ALL APPLICABLE EXPORT CONTROL RULES, REGULATIONS AND LIMITATIONS.

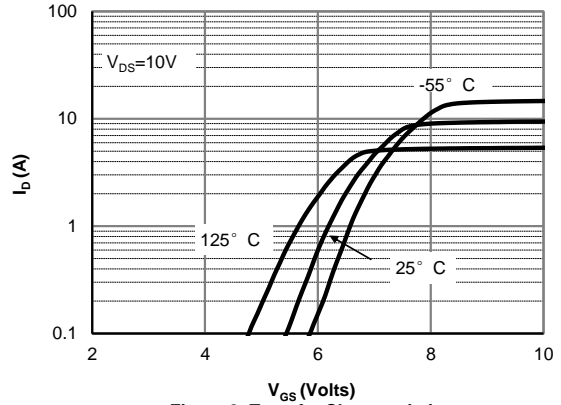
AOS' products are provided subject to AOS' terms and conditions of sale which are set forth at:

[http://www.aosmd.com/terms\\_and\\_conditions\\_of\\_sale](http://www.aosmd.com/terms_and_conditions_of_sale)

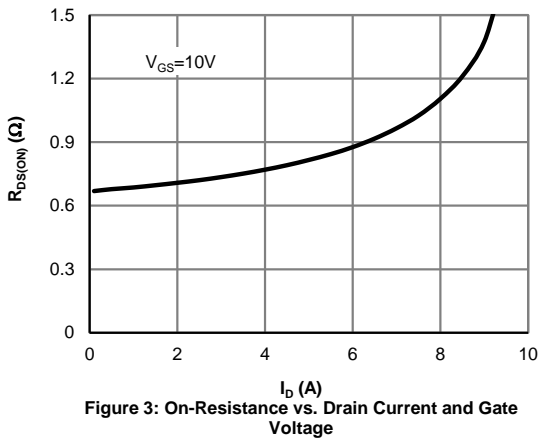
**TYPICAL ELECTRICAL AND THERMAL CHARACTERISTICS**



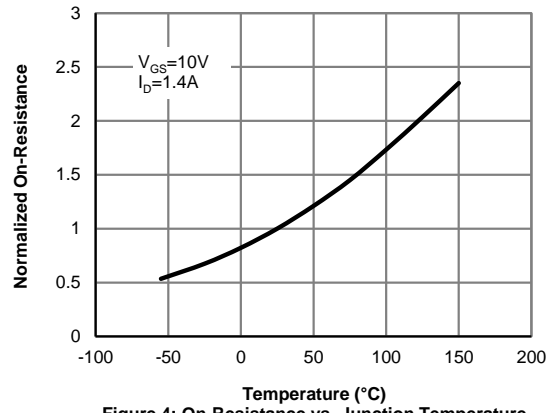
**Figure 1: On-Region Characteristics**



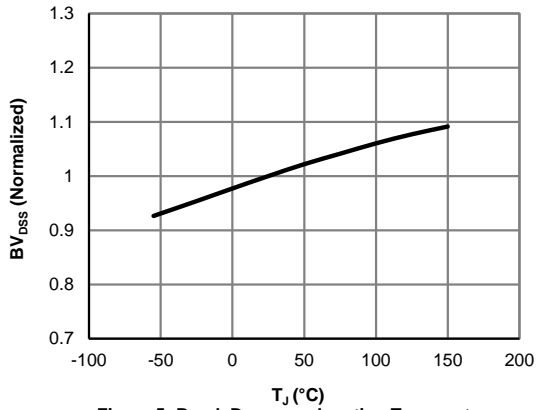
**Figure 2: Transfer Characteristics**



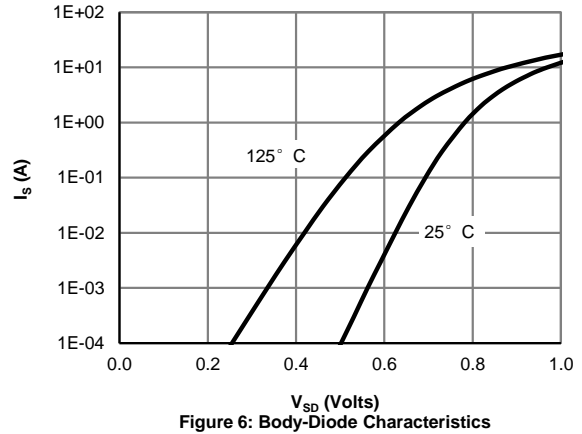
**Figure 3: On-Resistance vs. Drain Current and Gate Voltage**



**Figure 4: On-Resistance vs. Junction Temperature**

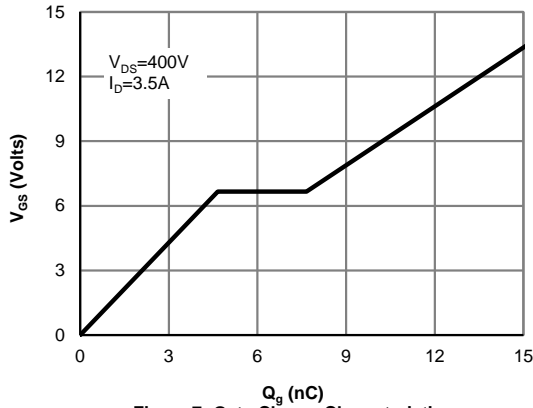


**Figure 5: Break Down vs. Junction Temperature**

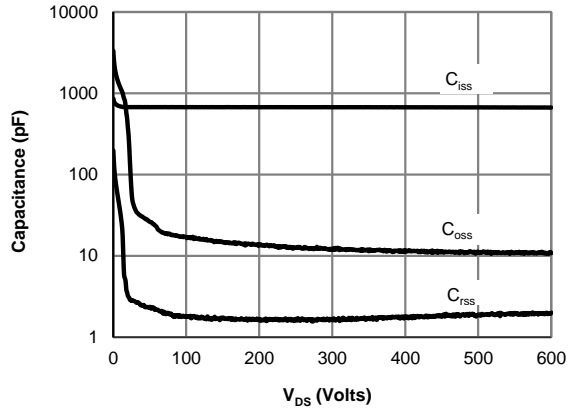


**Figure 6: Body-Diode Characteristics**

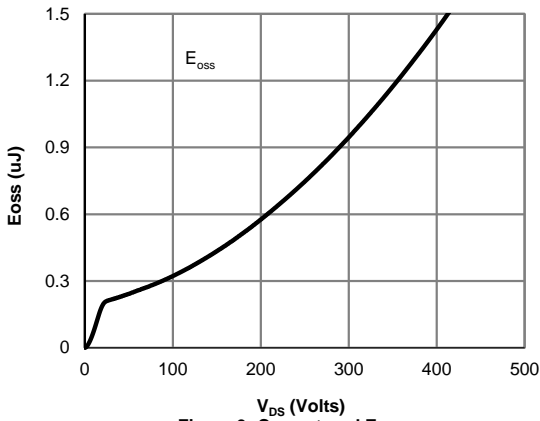
**TYPICAL ELECTRICAL AND THERMAL CHARACTERISTICS**



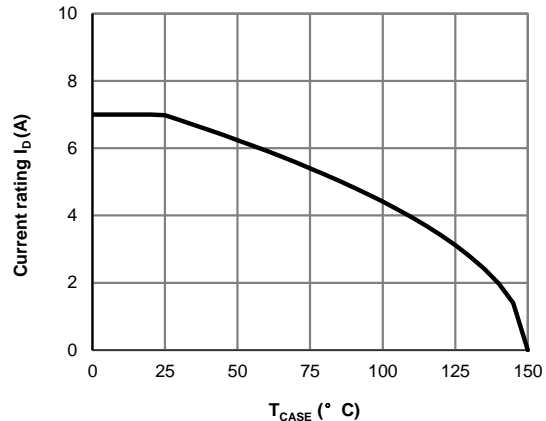
**Figure 7: Gate-Charge Characteristics**



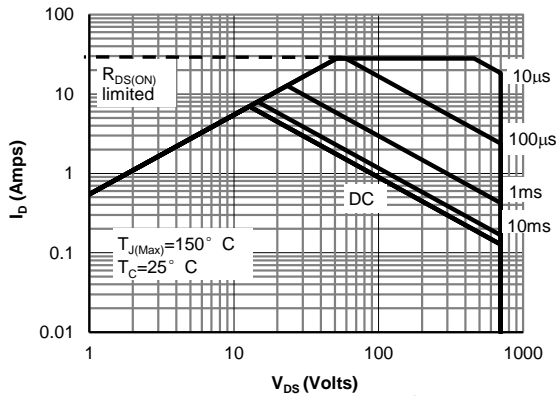
**Figure 8: Capacitance Characteristics**



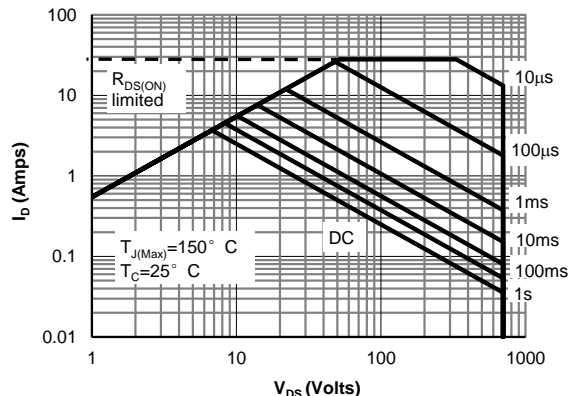
**Figure 9: Coss stored Energy**



**Figure 10: Current De-rating (Note F)**

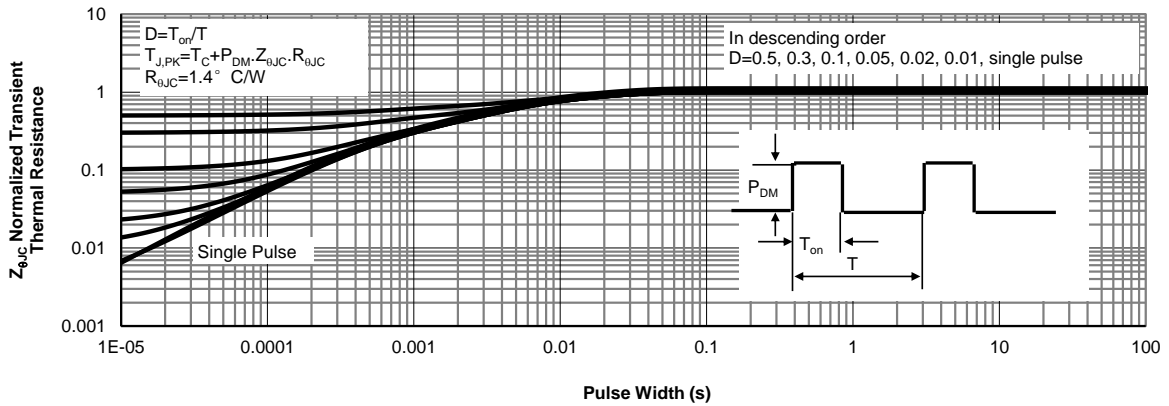


**Figure 11: Maximum Forward Biased Safe Operating Area for AOT(B)780A70L (Note F)**

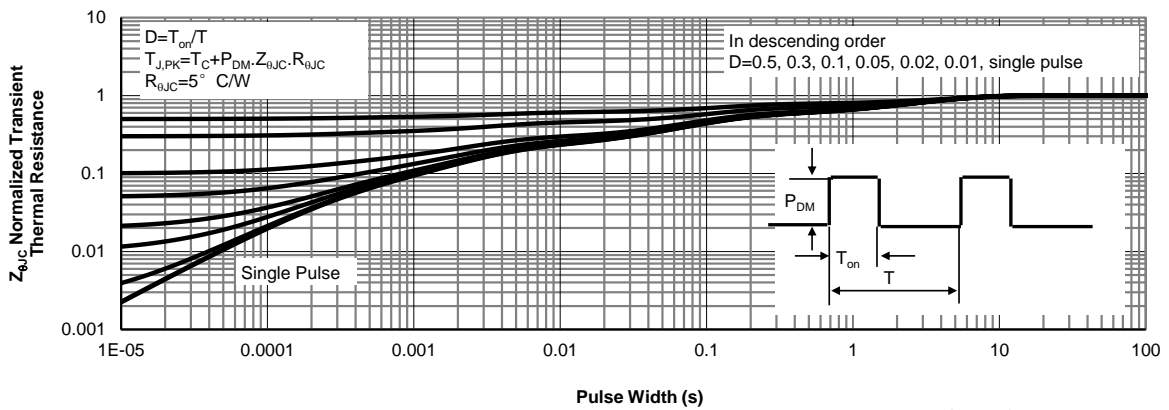


**Figure 12: Maximum Forward Biased Safe Operating Area for AOTF780A70L (Note F)**

**TYPICAL ELECTRICAL AND THERMAL CHARACTERISTICS**

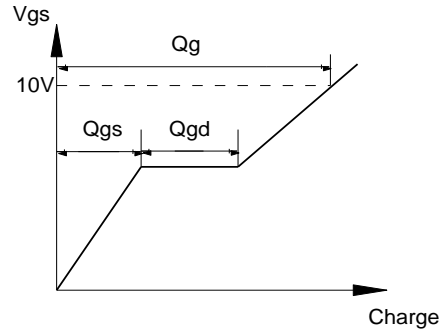
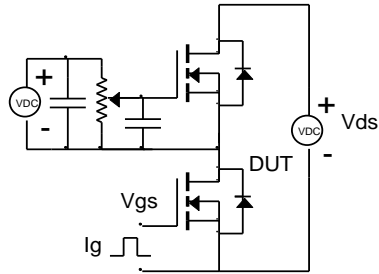


**Figure 13: Normalized Maximum Transient Thermal Impedance for AOT(B)780A70L (Note F)**

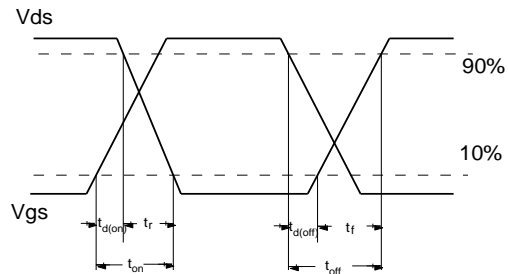
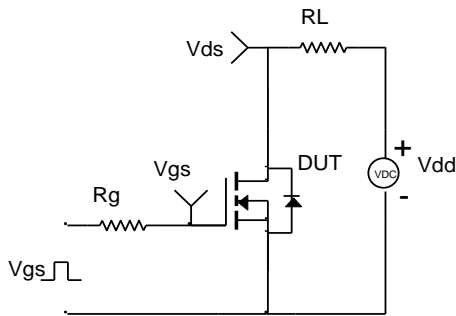


**Figure 14: Normalized Maximum Transient Thermal Impedance for AOTF780A70L (Note F)**

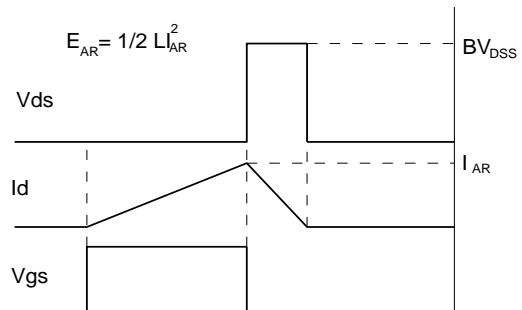
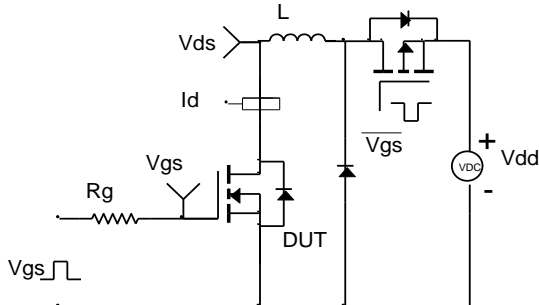
**Gate Charge Test Circuit & Waveform**



**Resistive Switching Test Circuit & Waveforms**



**Unclamped Inductive Switching (UIS) Test Circuit & Waveforms**



**Diode Recovery Test Circuit & Waveforms**

