

AO4408

N-Channel Enhancement Mode Field Effect Transistor

General Description

The AO4408/L uses advanced trench technology to provide excellent $R_{DS(ON)}$, low gate charge and fast switching. This device makes an excellent high side switch for notebook CPU core DC-DC conversion. AO4408 and AO4408L are electrically identical.

- RoHS Compliant
- AO4408L is Halogen Free

Features

V_{DS} (V) = 30V
 I_D = 12A (V_{GS} = 10V)
 $R_{DS(ON)} < 13m\Omega$ (V_{GS} = 10V)
 $R_{DS(ON)} < 16m\Omega$ (V_{GS} = 4.5V)

UIS Tested
Rg, Ciss, Coss, Crss Tested

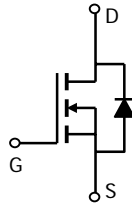
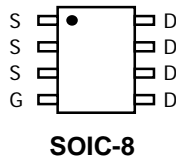

Absolute Maximum Ratings $T_A=25^\circ\text{C}$ unless otherwise noted

Parameter	Symbol	Maximum	Units
Drain-Source Voltage	V_{DS}	30	V
Gate-Source Voltage	V_{GS}	± 12	V
Continuous Drain Current ^{AF}	$T_A=25^\circ\text{C}$	12	A
	$T_A=70^\circ\text{C}$	10	
Pulsed Drain Current ^B	I_{DM}	80	
Avalanche Current ^B	I_{AV}	30	A
Repetitive Avalanche Energy ^B L=0.3mH	E_{AV}	135	mJ
Power Dissipation	$T_A=25^\circ\text{C}$	3	W
	$T_A=70^\circ\text{C}$	2.1	
Junction and Storage Temperature Range	T_J, T_{STG}	-55 to 150	$^\circ\text{C}$

Thermal Characteristics

Parameter		Symbol	Typ	Max	Units
Maximum Junction-to-Ambient ^A	$t \leq 10s$	$R_{\theta JA}$	23	40	$^\circ\text{C/W}$
	Steady-State		48	65	$^\circ\text{C/W}$
Maximum Junction-to-Lead ^C	Steady-State	$R_{\theta JL}$	12	16	$^\circ\text{C/W}$

Electrical Characteristics (T_J=25°C unless otherwise noted)

Symbol	Parameter	Conditions	Min	Typ	Max	Units
STATIC PARAMETERS						
BV _{DSS}	Drain-Source Breakdown Voltage	I _D =250μA, V _{GS} =0V	30			V
I _{DSS}	Zero Gate Voltage Drain Current	V _{DS} =30V, V _{GS} =0V T _J =55°C			1 5	μA
I _{GSS}	Gate-Body leakage current	V _{DS} =0V, V _{GS} =±12V			100	nA
V _{GS(th)}	Gate Threshold Voltage	V _{DS} =V _{GS} , I _D =250μA	1	1.5	2.5	V
I _{D(ON)}	On state drain current	V _{GS} =4.5V, V _{DS} =5V	40			A
R _{DS(ON)}	Static Drain-Source On-Resistance	V _{GS} =10V, I _D =12A T _J =125°C		10.5	14	mΩ
		V _{GS} =4.5V, I _D =10A		13	16.5	mΩ
g _{FS}	Forward Transconductance	V _{DS} =5V, I _D =10A	30	48		S
V _{SD}	Diode Forward Voltage	I _S =10A, V _{GS} =0V		0.76	1	V
I _S	Maximum Body-Diode Continuous Current				4.5	A
DYNAMIC PARAMETERS						
C _{iss}	Input Capacitance	V _{GS} =0V, V _{DS} =15V, f=1MHz		1020	1200	pF
C _{oss}	Output Capacitance			320		pF
C _{rss}	Reverse Transfer Capacitance			80	112	pF
R _g	Gate resistance	V _{GS} =0V, V _{DS} =0V, f=1MHz	0.13	0.25	0.5	Ω
SWITCHING PARAMETERS						
Q _g	Total Gate Charge	V _{GS} =4.5V, V _{DS} =15V, I _D =12A		10.3	12.5	nC
Q _{gs}	Gate Source Charge			2.1		nC
Q _{gd}	Gate Drain Charge			3.9		nC
t _{D(on)}	Turn-On Delay Time	V _{GS} =10V, V _{DS} =15V, R _L =1.2Ω, R _{GEN} =3Ω		3.9	5.5	ns
t _r	Turn-On Rise Time			3	6	ns
t _{D(off)}	Turn-Off Delay Time			19.2	30	ns
t _f	Turn-Off Fall Time			2.6	5	ns
t _{rr}	Body Diode Reverse Recovery Time	I _F =12A, dI/dt=100A/μs		26	32	ns
Q _{rr}	Body Diode Reverse Recovery Charge	I _F =12A, dI/dt=100A/μs		18	32	nC

A: The value of R_{θJA} is measured with the device mounted on 1 in 2 FR-4 board with 2oz. Copper, in a still air environment with T_A=25°C. The value in any given application depends on the user's specific board design.

B: Repetitive rating, pulse width limited by junction temperature.

C: The R_{θJA} is the sum of the thermal impedance from junction to lead R_{θJL} and lead to ambient.

D: The static characteristics in Figures 1 to 6 are obtained using <300μs pulses, duty cycle 0.5% max.

E: These tests are performed with the device mounted on 1 in 2 FR-4 board with 2oz. Copper, in a still air environment with T_A=25°C. The SOA curve provides a single pulse rating.

F: The current rating is based on the ≤ 10s junction to ambient thermal resistance rating.

Rev8: July 2008

THIS PRODUCT HAS BEEN DESIGNED AND QUALIFIED FOR THE CONSUMER MARKET. APPLICATIONS OR USES AS CRITICAL COMPONENTS IN LIFE SUPPORT DEVICES OR SYSTEMS ARE NOT AUTHORIZED. AOS DOES NOT ASSUME ANY LIABILITY ARISING OUT OF SUCH APPLICATIONS OR USES OF ITS PRODUCTS. AOS RESERVES THE RIGHT TO IMPROVE PRODUCT DESIGN, FUNCTIONS AND RELIABILITY WITHOUT NOTICE.

TYPICAL ELECTRICAL AND THERMAL CHARACTERISTICS

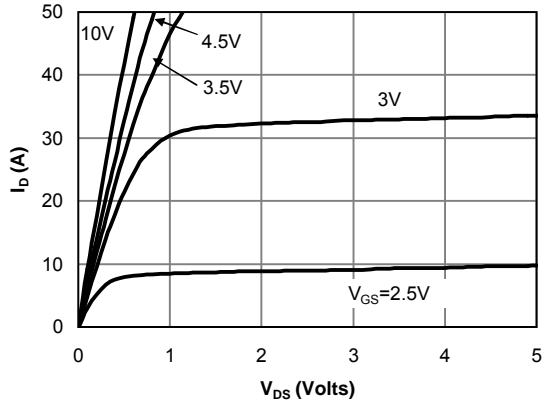

Fig 1: On-Region Characteristics

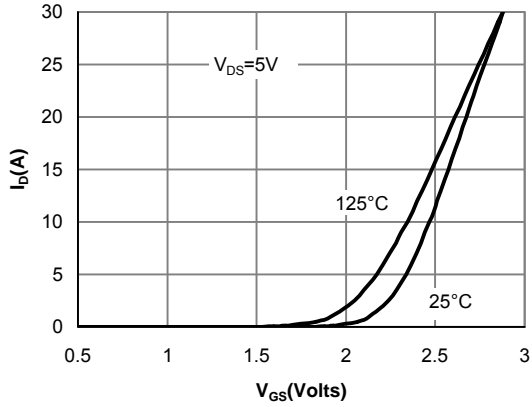

Figure 2: Transfer Characteristics

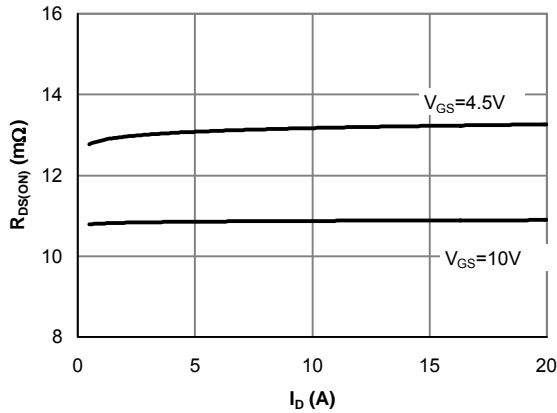

Figure 3: On-Resistance vs. Drain Current and Gate Voltage

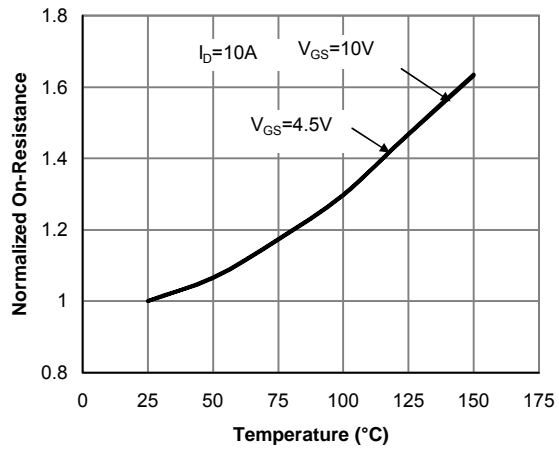

Figure 4: On-Resistance vs. Junction Temperature

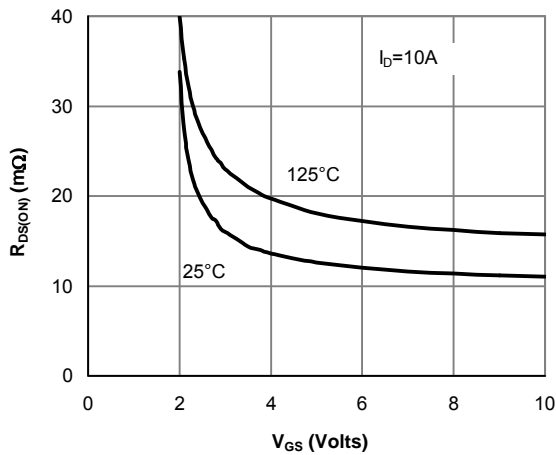

Figure 5: On-Resistance vs. Gate-Source Voltage

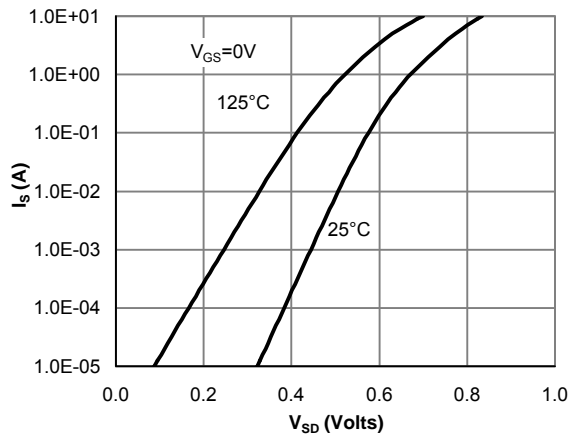

Figure 6: Body-Diode Characteristics

TYPICAL ELECTRICAL AND THERMAL CHARACTERISTICS

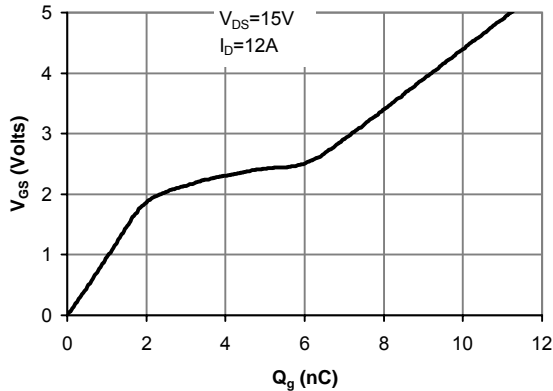

Figure 7: Gate-Charge Characteristics

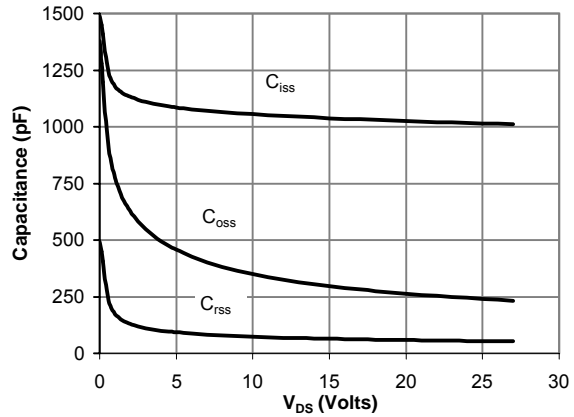

Figure 8: Capacitance Characteristics

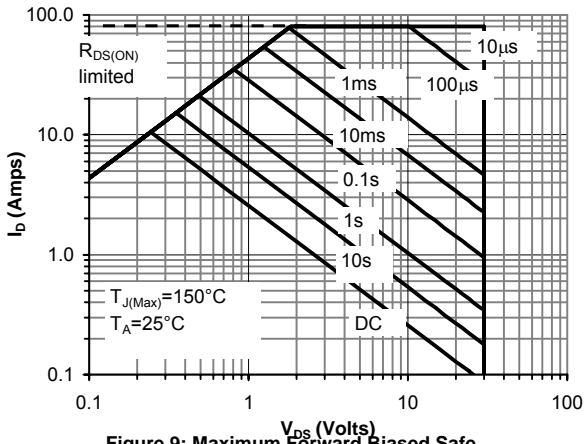

Figure 9: Maximum Forward Biased Safe Operating Area (Note E)

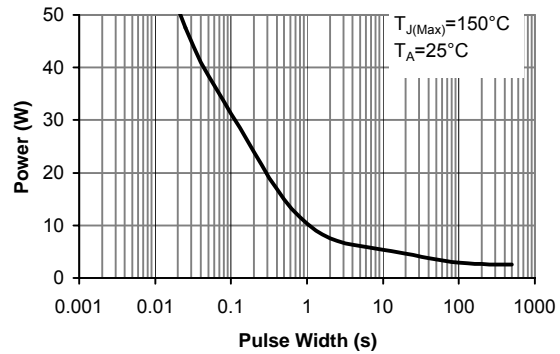

Figure 10: Single Pulse Power Rating Junction-to-Ambient (Note E)

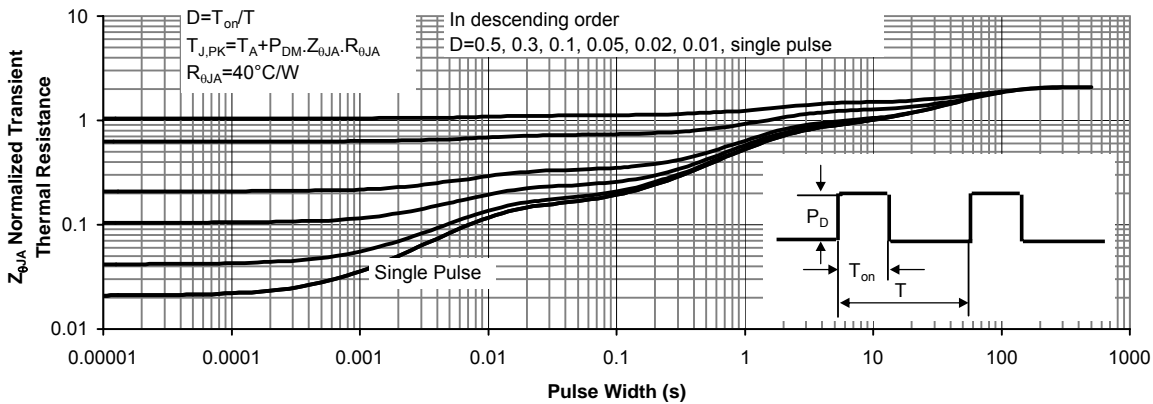

Figure 11: Normalized Maximum Transient Thermal Impedance

TYPICAL ELECTRICAL AND THERMAL CHARACTERISTICS

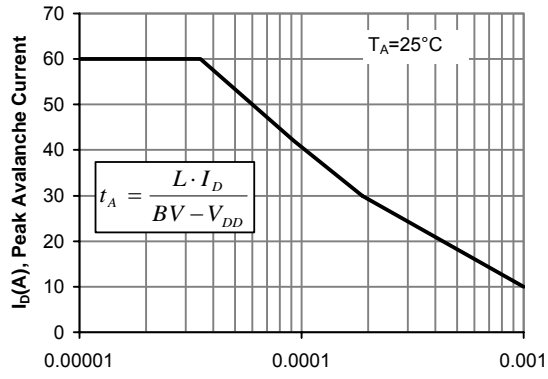

Figure 12: Avalanche capability

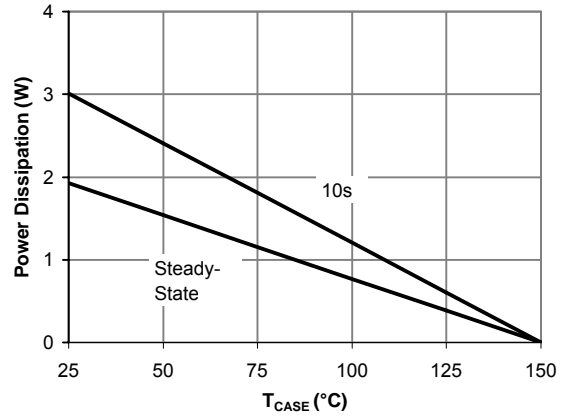
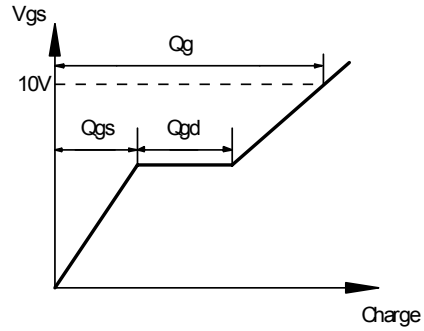
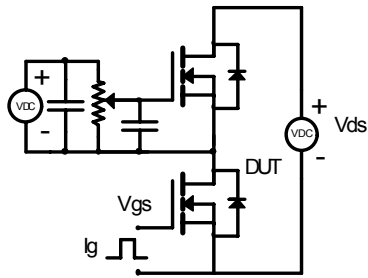
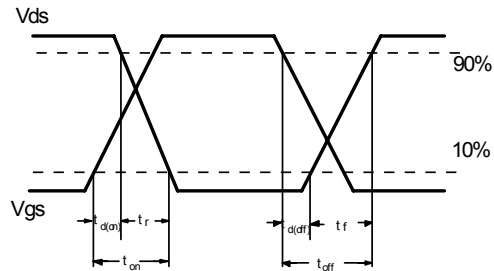
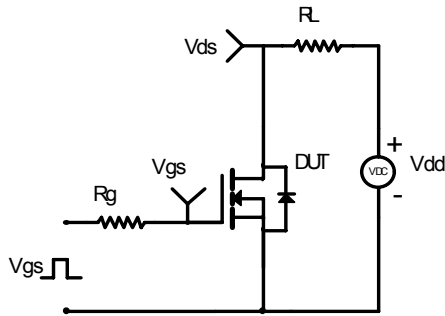

Figure 13: Power De-rating (Note A)

Gate Charge Test Circuit & Waveform



Resistive Switching Test Circuit & Waveforms



Unclamped Inductive Switching (UIS) Test Circuit & Waveforms

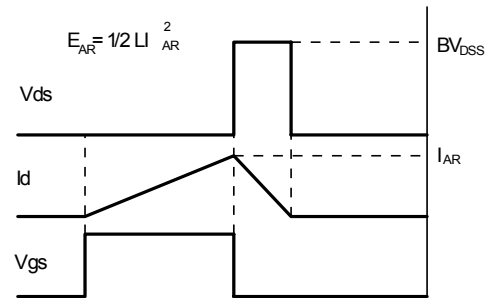
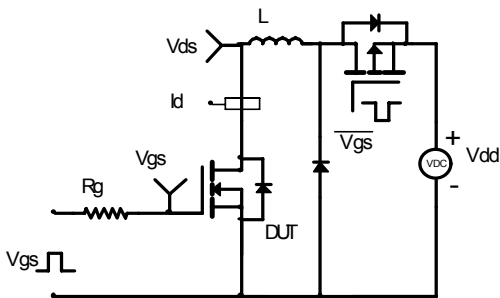

Diode Recovery Test Circuit & Waveforms

