

AOD464

N-Channel Enhancement Mode Field Effect Transistor

General Description

The AOD464 uses advanced trench technology and design to provide excellent $R_{DS(ON)}$ with low gate charge. This device is suitable for use in high voltage synchronous rectification, load switching and general purpose applications.

- RoHS Compliant
- Halogen Free*

Features

V_{DS} (V) = 105V
 I_D = 40 A ($V_{GS} = 10V$)
 $R_{DS(ON)} < 28 \text{ m}\Omega$ ($V_{GS} = 10V$) @ 20A
 $R_{DS(ON)} < 31 \text{ m}\Omega$ ($V_{GS} = 6V$)

100% UIS Tested!
100% Rg Tested!

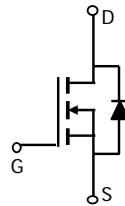
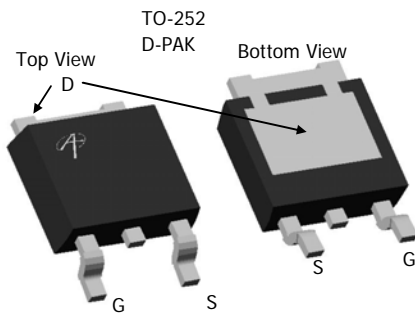

Absolute Maximum Ratings $T_A=25^\circ\text{C}$ unless otherwise noted

Parameter	Symbol	Maximum	Units
Drain-Source Voltage	V_{DS}	105	V
Gate-Source Voltage	V_{GS}	± 25	V
Continuous Drain Current	I_D	$T_C=25^\circ\text{C}$	40
		$T_C=100^\circ\text{C}$	28
Pulsed Drain Current ^C	I_{DM}	80	A
Avalanche Current ^C	I_{AR}	20	A
Repetitive avalanche energy $L=0.1\text{mH}$ ^C	E_{AR}	20	mJ
Power Dissipation ^B	P_D	$T_C=25^\circ\text{C}$	100
		$T_C=100^\circ\text{C}$	50
Power Dissipation ^A	P_{DSM}	$T_A=25^\circ\text{C}$	2.3
		$T_A=70^\circ\text{C}$	1.5
Junction and Storage Temperature Range	T_J, T_{STG}	-55 to 175	$^\circ\text{C}$

Thermal Characteristics

Parameter	Symbol	Typ	Max	Units
Maximum Junction-to-Ambient ^A	$R_{\theta JA}$	$t \leq 10\text{s}$	15	$^\circ\text{C/W}$
Maximum Junction-to-Ambient ^A		Steady-State	45	$^\circ\text{C/W}$
Maximum Junction-to-Case ^B	$R_{\theta JC}$	1	1.5	$^\circ\text{C/W}$

Electrical Characteristics (T_J=25°C unless otherwise noted)

Symbol	Parameter	Conditions	Min	Typ	Max	Units
STATIC PARAMETERS						
BV _{DSS}	Drain-Source Breakdown Voltage	I _D =10mA, V _{GS} =0V	105			V
I _{DSS}	Zero Gate Voltage Drain Current	V _{DS} =84V, V _{GS} =0V T _J =55°C			1 5	μA
I _{GSS}	Gate-Body leakage current	V _{DS} =0V, V _{GS} =±25V			100	nA
V _{GS(th)}	Gate Threshold Voltage	V _{DS} =V _{GS} , I _D =250μA	2.5	3.2	4	V
I _{D(ON)}	On state drain current	V _{GS} =10V, V _{DS} =5V	80			A
R _{DS(ON)}	Static Drain-Source On-Resistance	V _{GS} =10V, I _D =20A		21.5	28	mΩ
		T _J =125°C		32	40	
		V _{GS} =6V, I _D =20A		24	31	mΩ
g _{FS}	Forward Transconductance	V _{DS} =5V, I _D =20A		50		S
V _{SD}	Diode Forward Voltage	I _S =1A, V _{GS} =0V		0.73	1	V
I _S	Maximum Body-Diode Continuous Current				55	A
DYNAMIC PARAMETERS						
C _{iss}	Input Capacitance	V _{GS} =0V, V _{DS} =25V, f=1MHz		2038	2445	pF
C _{oss}	Output Capacitance			204		pF
C _{rss}	Reverse Transfer Capacitance			85		pF
R _g	Gate resistance	V _{GS} =0V, V _{DS} =0V, f=1MHz		1.3	1.56	Ω
SWITCHING PARAMETERS						
Q _{g(10V)}	Total Gate Charge	V _{GS} =10V, V _{DS} =50V, I _D =20A		38.5	46	nC
Q _{gs}	Gate Source Charge			8		nC
Q _{gd}	Gate Drain Charge			10		nC
t _{D(on)}	Turn-On Delay Time	V _{GS} =10V, V _{DS} =50V, R _L =2.7Ω, R _{GEN} =3Ω		12.7		ns
t _r	Turn-On Rise Time			8.2		ns
t _{D(off)}	Turn-Off Delay Time			31.5		ns
t _f	Turn-Off Fall Time			11.2		ns
t _{rr}	Body Diode Reverse Recovery Time	I _F =20A, dI/dt=100A/μs		59.6	74	ns
Q _{rr}	Body Diode Reverse Recovery Charge	I _F =20A, dI/dt=100A/μs		161		nC

A: The value of R_{θJA} is measured with the device mounted on 1in² FR-4 board with 2oz. Copper, in a still air environment with T_A=25°C. The Power dissipation P_{DSM} is based on R_{θJA} and the maximum allowed junction temperature of 150°C. The value in any given application depends on the user's specific board design, and the maximum temperature of 175°C may be used if the PCB allows it.

B: The power dissipation P_D is based on T_{J(MAX)}=175°C, using junction-to-case thermal resistance, and is more useful in setting the upper dissipation limit for cases where additional heatsinking is used.

C: Repetitive rating, pulse width limited by junction temperature T_{J(MAX)}=175°C.

D: The R_{θJA} is the sum of the thermal impedance from junction to case R_{θJC} and case to ambient.

E: The static characteristics in Figures 1 to 6 are obtained using <300 μs pulses, duty cycle 0.5% max.

F: These curves are based on the junction-to-case thermal impedance which is measured with the device mounted to a large heatsink, assuming a maximum junction temperature of T_{J(MAX)}=175°C.

G: The maximum current rating is limited by bond-wires.

H: These tests are performed with the device mounted on 1 in² FR-4 board with 2oz. Copper, in a still air environment with T_A=25°C. The SOA curve provides a single pulse rating.

*This device is guaranteed green after data code 8X11 (Sep 1ST 2008).

Rev1: Sep. 2008

THIS PRODUCT HAS BEEN DESIGNED AND QUALIFIED FOR THE CONSUMER MARKET. APPLICATIONS OR USES AS CRITICAL COMPONENTS IN LIFE SUPPORT DEVICES OR SYSTEMS ARE NOT AUTHORIZED. AOS DOES NOT ASSUME ANY LIABILITY ARISING OUT OF SUCH APPLICATIONS OR USES OF ITS PRODUCTS. AOS RESERVES THE RIGHT TO IMPROVE PRODUCT DESIGN, FUNCTIONS AND RELIABILITY WITHOUT NOTICE. Rev0: July2005

TYPICAL ELECTRICAL AND THERMAL CHARACTERISTICS

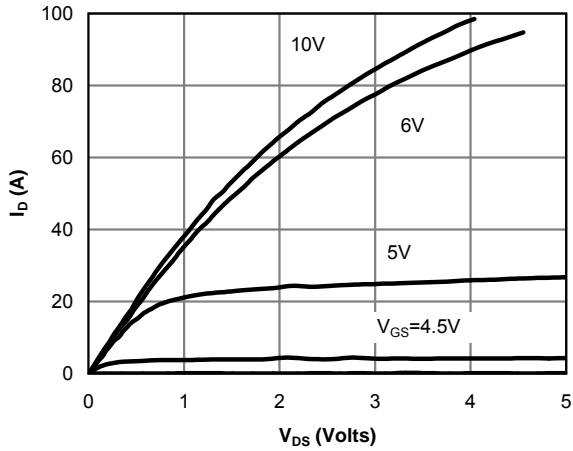

Fig 1: On-Region Characteristics

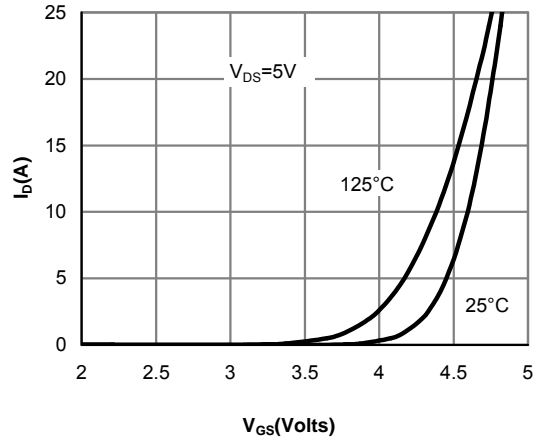

Figure 2: Transfer Characteristics

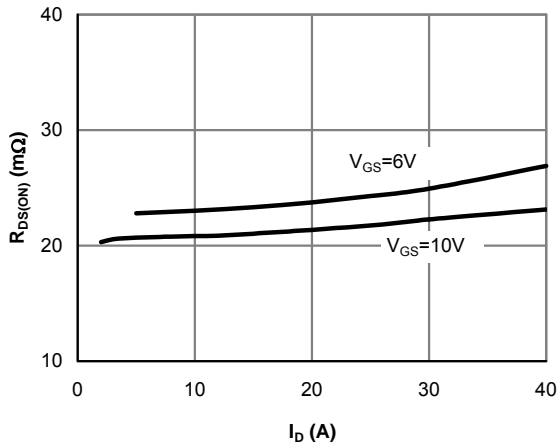

Figure 3: On-Resistance vs. Drain Current and Gate Voltage

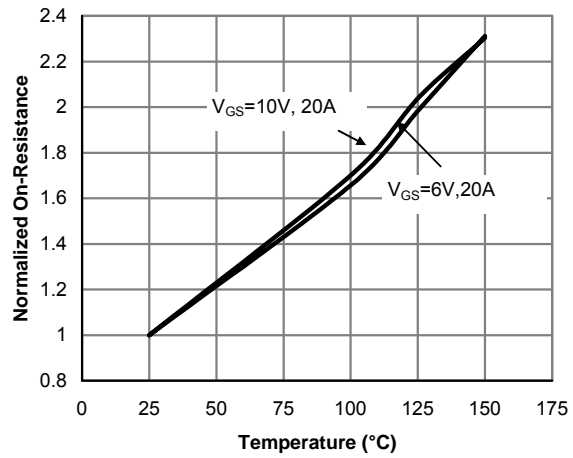

Figure 4: On-Resistance vs. Junction Temperature

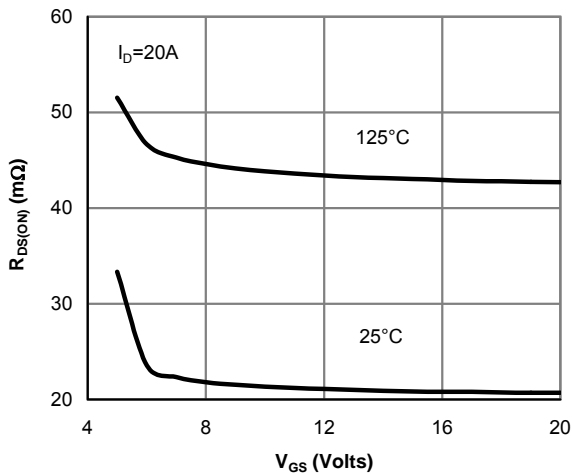

Figure 5: On-Resistance vs. Gate-Source Voltage

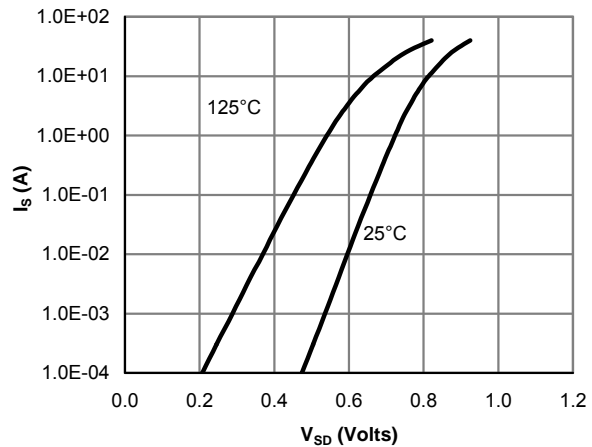

Figure 6: Body-Diode Characteristics

TYPICAL ELECTRICAL AND THERMAL CHARACTERISTICS

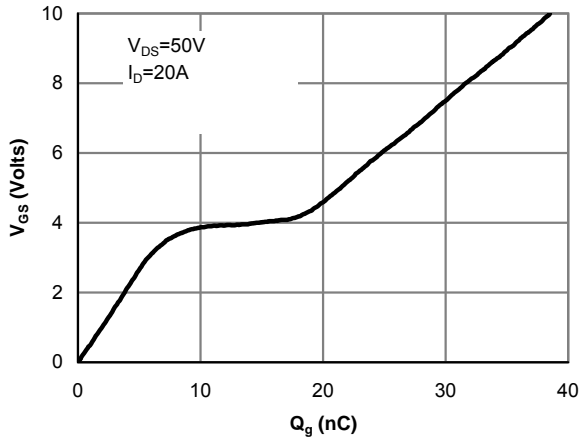

Figure 7: Gate-Charge Characteristics

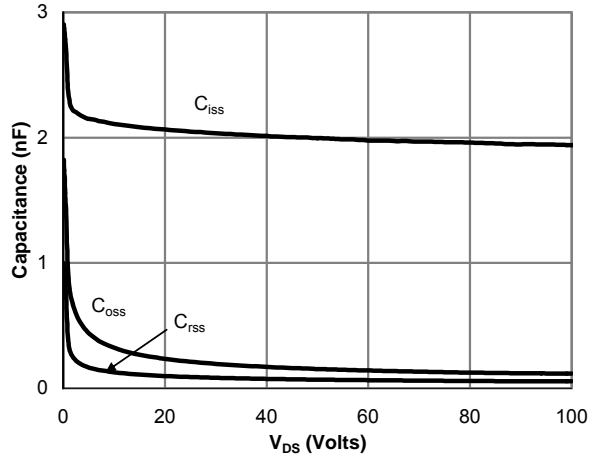

Figure 8: Capacitance Characteristics

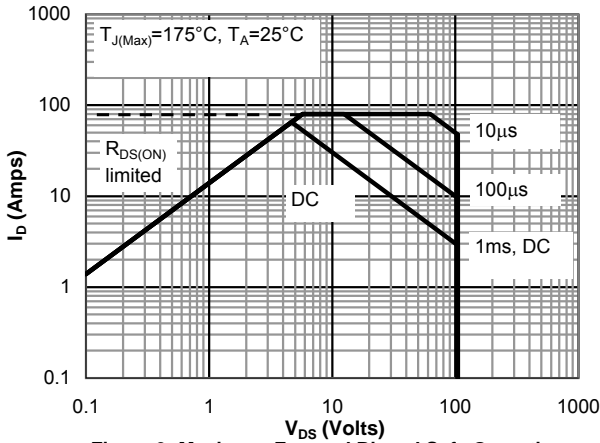

Figure 9: Maximum Forward Biased Safe Operating Area (Note F)

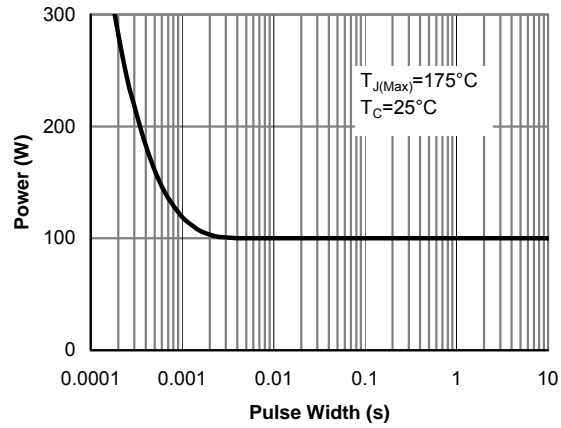

Figure 10: Single Pulse Power Rating Junction-to-Case (Note F)

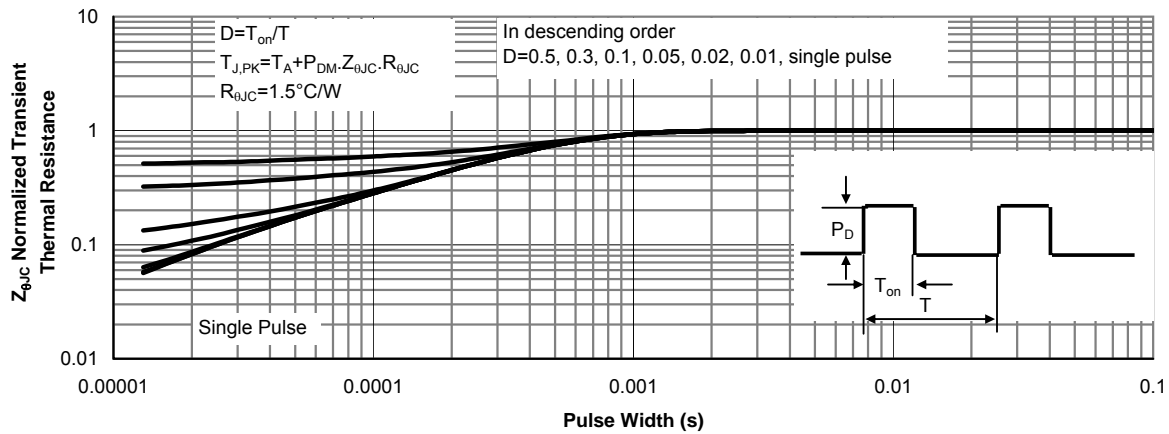

Figure 11: Normalized Maximum Transient Thermal Impedance (Note F)

TYPICAL ELECTRICAL AND THERMAL CHARACTERISTICS

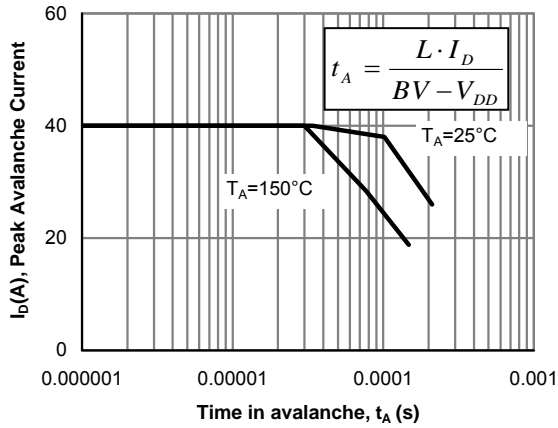

Figure 12: Single Pulse Avalanche capability

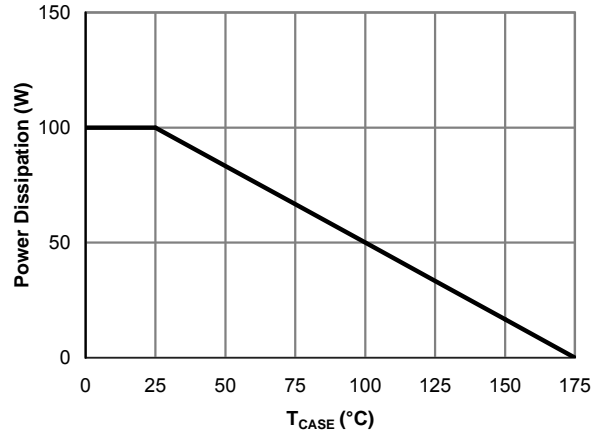

Figure 13: Power De-rating (Note B)

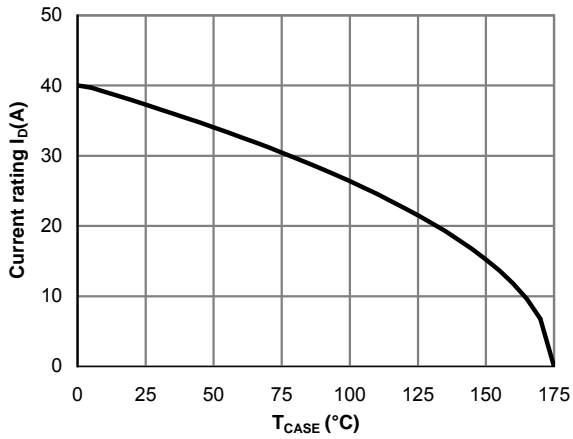

Figure 14: Current De-rating (Note B)

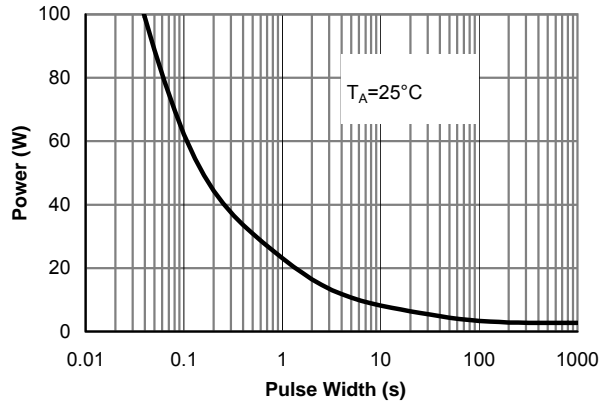

Figure 15: Single Pulse Power Rating Junction-to-Ambient (Note H)

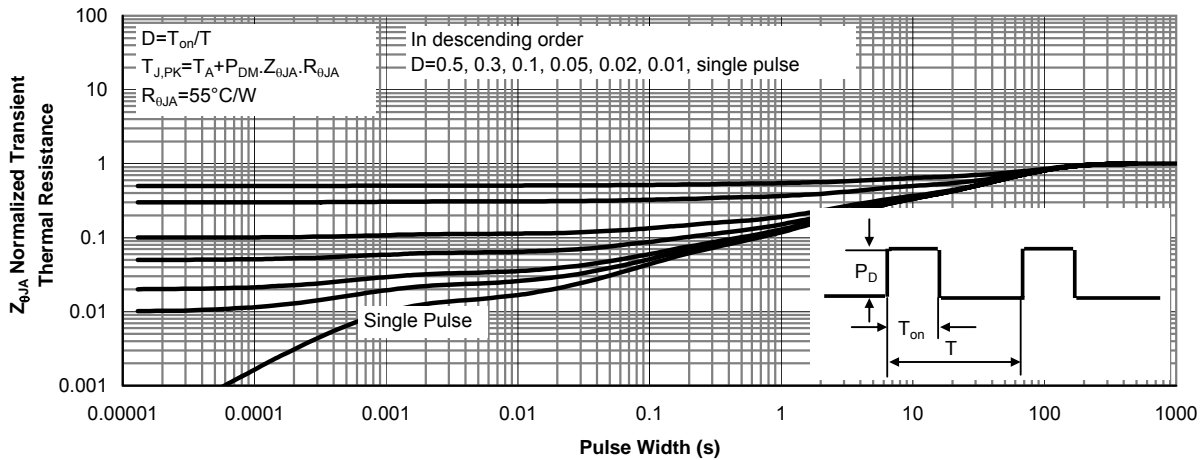
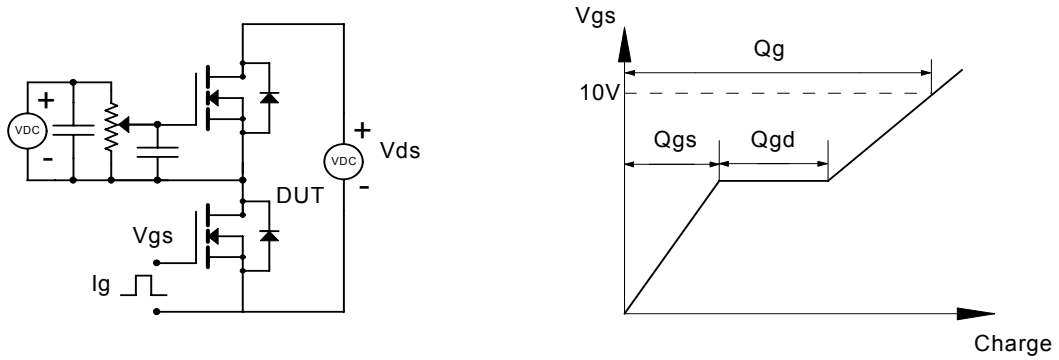
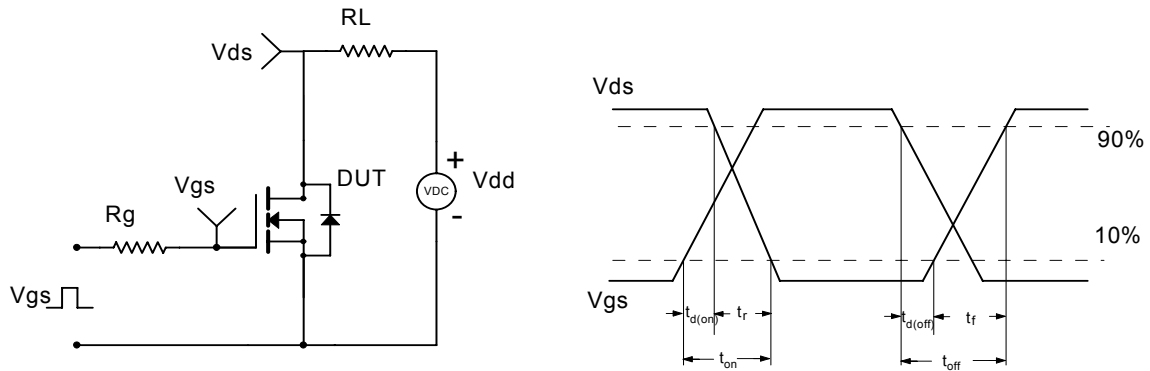

Figure 16: Normalized Maximum Transient Thermal Impedance (Note H)

Gate Charge Test Circuit & Waveform



Resistive Switching Test Circuit & Waveforms



Unclamped Inductive Switching (UIS) Test Circuit & Waveforms

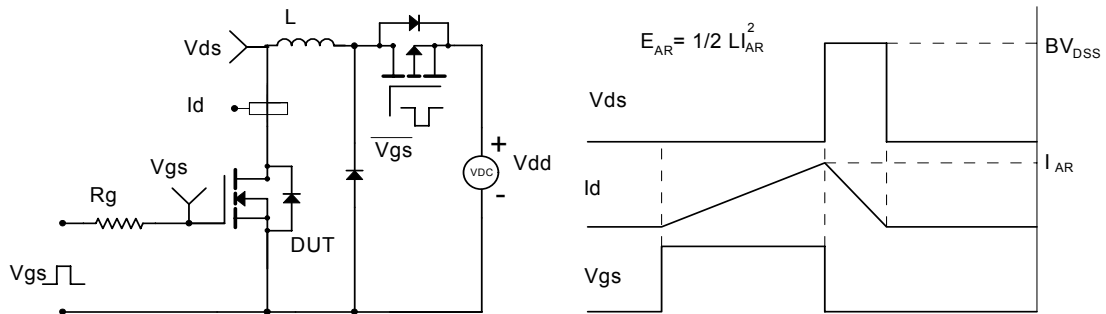

Diode Recovery Test Circuit & Waveforms

