

General Description

The AOZ1328DI power switch is intended for applications that require circuit protections. The input operating voltage ranges between 3.4V and 22V, making it ideal for USB Type-C power delivery applications. The VIN terminal is rated as 28V Absolute Maximum. The AOZ1328DI provides under-voltage lockout, over-voltage and over-temperature protection function. The over-voltage protection threshold is selectable through the POVP pin. The internal soft-start circuitry controls inrush current due to highly capacitive loads. The slew rate can be adjusted using an external capacitor.

The AOZ1328DI has True Reverse Current Blocking (TRCB) protection to avoid undesired reverse-current from VOUT to VIN at all time.

The AOZ1328DI is available in a thermally enhanced 3mm x 3mm DFN-12 package which can operate over -40°C to +125°C junction temperature range.

Features

- 18mΩ typical ON resistance
- 9A continuous current
- 20A peak current for 10ms @ 2% duty cycle
- 3.4V to 22V operating input voltage
- VIN, VOUT are rated 28V Abs max.
- True reverse current blocking
- Selectable over-voltage protection
- Programmable soft-start
- VIN Under-voltage lockout
- VIN and VOUT over-voltage lockout
- Thermal shutdown protection
- ±4kV HBM ESD rating
- IEC 61000-4-2: ±8kV on VIN
- IEC 61000-4-5: 40V on VOUT, No Capacitor
- DFN3x3-12L package

Applications

- Thunderbolt/USB Type-C PD power switch
- Portable devices
- Notebook/desktop computers
- Monitors
- Docking station/dongles



Typical Application

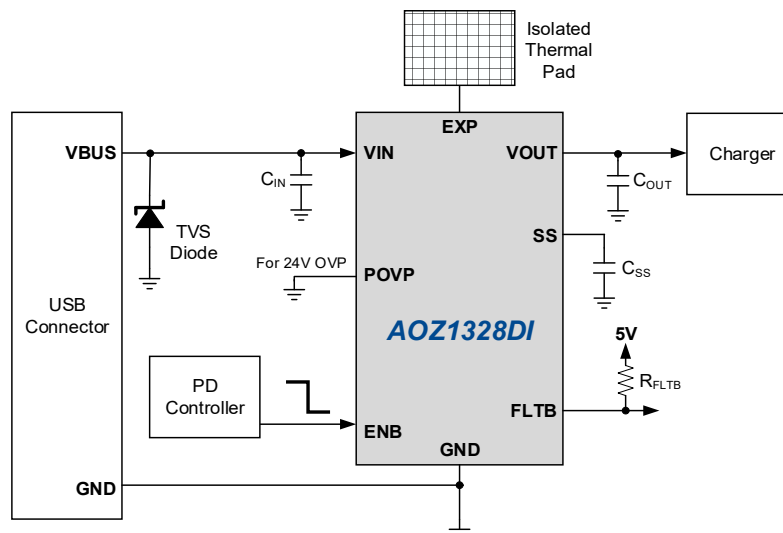

Ordering Information

Part Number	Fault Recovery	Junction Temperature Range	Package	Environmental
AOZ1328DI-01	Auto-Restart	-40°C to +125°C	DFN3x3-12L	RoHS
AOZ1328DI-02	Latch-Off	-40°C to +125°C	DFN3x3-12L	RoHS



All AOS products are offered in packages with Pb-free plating and compliant to RoHS standards. Please visit www.aosmd.com/media/AOSGreenPolicy.pdf for additional information.

Pin Configuration

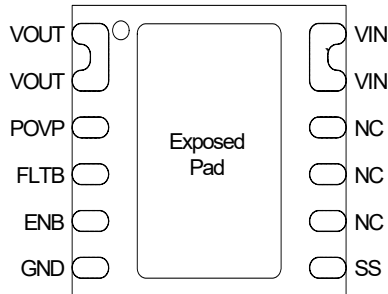

DFN3x3-12L
(Top Transparent View)

Pin Description

Pin Number	Pin Name	Pin Function
1, 2	VOUT	Output pins. Connect to internal load.
3	POVP	Over voltage protection pin. Connect POVP to GND for 24V or leave open for 5.8V OVP.
4	FLTB	Fault Indicator, Open-drain output. Active Low when fault condition occurs.
5	ENB	Enable logic input. Active-low.
6	GND	Ground.
7	SS	Soft-start pin. Connect a capacitor CSS from SS to GND to set the soft-start time.
8, 9, 10	NC	No connect. Leave these pins float.
11, 12	VIN	Connect to adapter or power input.
EXP	EXP	Exposed Thermal Pad. It is the common drain node of the internal back-back sink switches and it must be electrically isolated. Solder to a metal surface directly underneath EXP and connect to floating Cu thermal pads on multiple PCB layers through VIAs. For best thermal performance make the floating Cu pads as large as possible and connect to EXP with multiple VIAs

Absolute Maximum Ratings

Exceeding the Absolute Maximum ratings may damage the device.

Parameter	Rating
VIN, VOUT to GND	-0.3V to +28V
ENB, SS, FLTB, POVP to GND	-0.3V to +6V
Junction Temperature (T _J)	+150°C
Storage Temperature (T _S)	-65°C to +150°C
ESD Rating HBM All Pins	±4kV
IEC 61000-4-2: VIN	±8kV

Recommend Operating Ratings

The device is not guaranteed to operate beyond the Maximum Operating Ratings.

Parameter	Rating
VIN, VOUT to GND	3.4V to 22V
ENB, FLTB to GND	0 to 5.5V
POVP, SS to GND	0 to 3V
Switch Current (I _{SW})	0A to 9A
Peak Switch Current (I _{SW_PK}) 10ms @ 2% Duty Cycle	20A
Junction Temperature (T _J)	-40°C to +125°C
Package Thermal Resistance DFN3x3-12 (Θ _{JA})	36°C/W

Electrical Characteristics

T_A = 25°C, VIN = 20V, ENB = 0V, POVP = 0V, unless otherwise specified.

Symbol	Parameter	Conditions	Min.	Typ.	Max.	Units
V _{VIN}	Input Supply Voltage		3.4		22	V
V _{UVLO}	Under-voltage Lockout Threshold	VIN rising	3.0		3.35	V
V _{UVLO_HYS}	Under-voltage Lockout Hysteresis			300		mV
V _{OVLO}	Over-voltage Lockout Threshold	POVP = GND, VIN rising	23.0	24.0	25.0	V
		POVP Open, VIN rising	5.5	5.8	6	
V _{OVLO_HYS}	Over-voltage Lockout Hysteresis			350		mV
t _{DELAY_OVP}	Switch Turn-off Delay upon Over-voltage	V _{VIN} -V _{OVLO} = 500mV		1		μs
I _{VIN_ON}	Input Quiescent Current	I _{VOUT} = 0		550		μA
I _{VIN_OFF}	Input Shutdown Current	I _{VOUT} = 0, ENB = 5V		18	35	μA
I _{VOUT_OFF}	Output Leakage Current	V _{OUT} = 20V, V _{VIN} = 0V, ENB = 5V		18	35	μA
R _{ON_20V}	Switch ON-Resistance	I _{VOUT} = 1A		18		mΩ
R _{ON_5V}		V _{VIN} = 5V, I _{VOUT} = 1A		19		mΩ
V _{ENB_H}	ENB Pin Input High Threshold	ENB rising			1.4	V
V _{ENB_L}	ENB Pin Input Low Threshold	ENB falling	0.6			V
I _{ENB_BIAS}	ENB Pin Input Pull-down Current	ENB = 1.8 V			10	μA
V _{FLTB_LO}	FLTB Pin Pull-down Voltage	FLTB sinking 3mA			0.3	V
V _{TRCB}	TRCB Threshold	V _{OUT} -V _{VIN}		26		mV
t _{TRCB}	TRCB Delay Time	V _{OUT} -V _{VIN} = V _{TRCB} +500mV		500		ns
t _{D_ON}	Turn-On Delay Time ENB to VOUT (10%)	From ENB falling edge to VOUT reaching 10% of VIN. C _{OUT} = 68μF, C _{SS} = 5.6nF		20		ms
t _{ON}	Turn-On Rise Time	VOUT from 10% to 90% C _{OUT} = 68μF, C _{SS} = 5.6nF		1.9		ms
t _{REC}	Auto Restart Interval	AOZ1328DI-01		64		ms
T _{SD}	Thermal Shutdown Threshold			140		°C
T _{SD_HYS}	Thermal Shutdown Hysteresis			30		°C

Functional Block Diagram

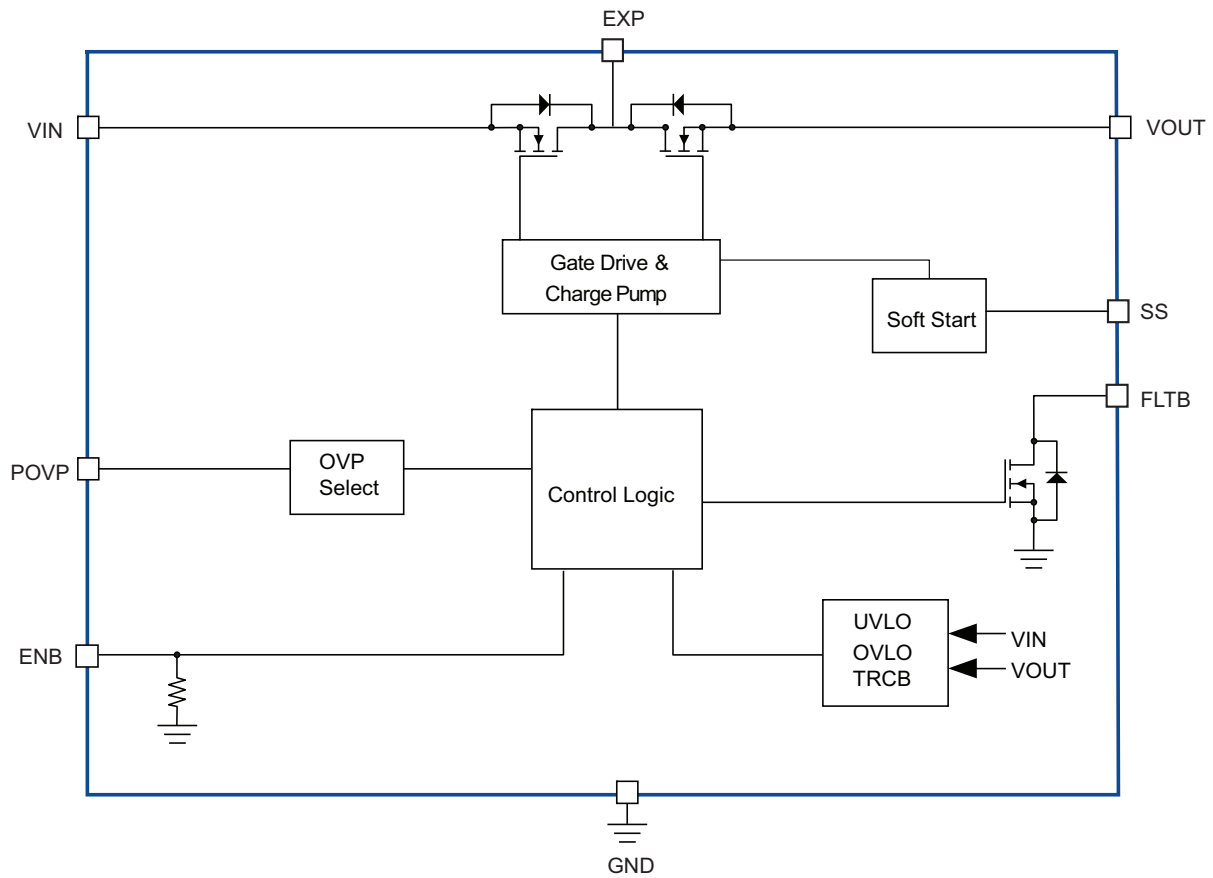

Timing Diagrams

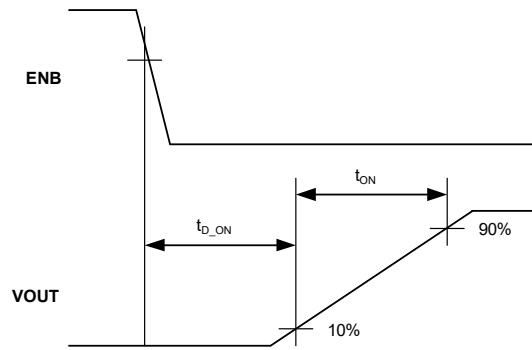

Figure 1. Turn-on Delay and Turn-on Time

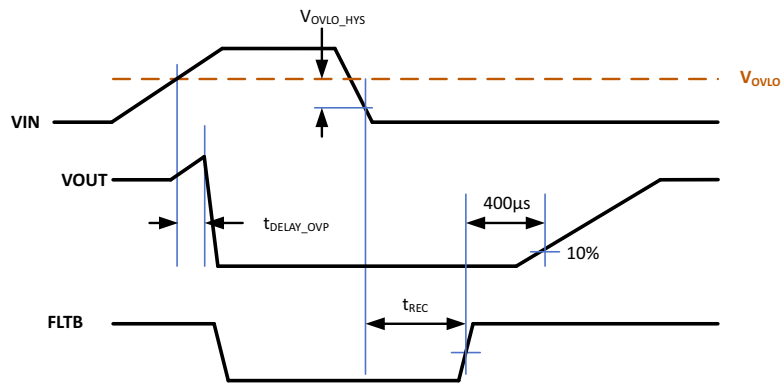

Figure 2. OVP Delay and Recovery Time (AOZ1328DI-01)

Typical Characteristics

$C_{IN} = 10\mu F$, $C_{OUT} = 120\mu F$, $R_{LOAD} = 100\Omega$, $C_{SS} = 5.6nF$, $POVP = GND$, $T_A = 25^\circ C$ unless otherwise specified.

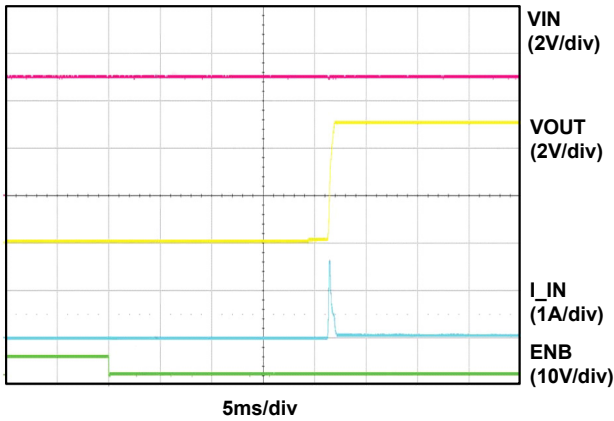

Figure 3. Soft Start Delay Times (VIN = 5V)

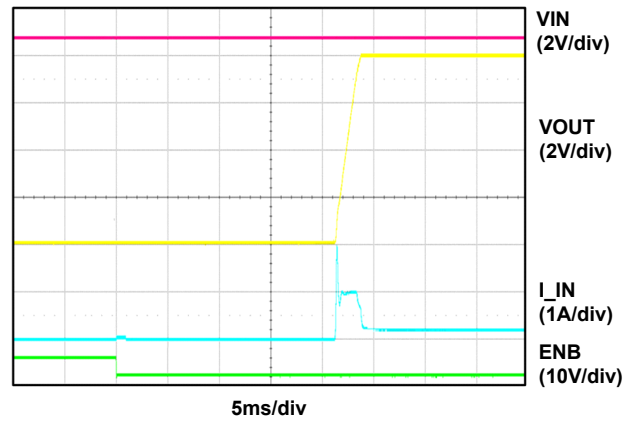

Figure 4. Soft Start Delay Times (VIN = 20V)

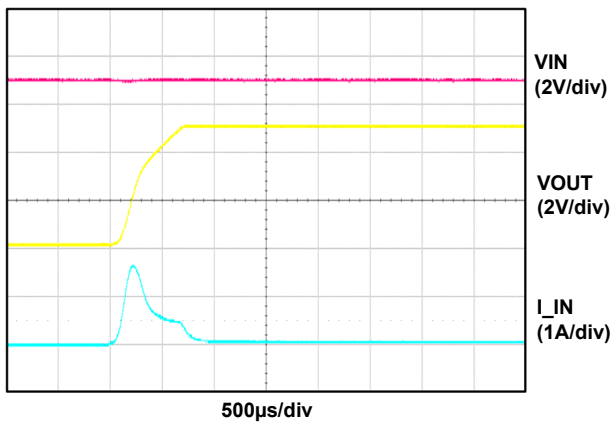

Figure 5. Soft Start Ramp (VIN = 5V)

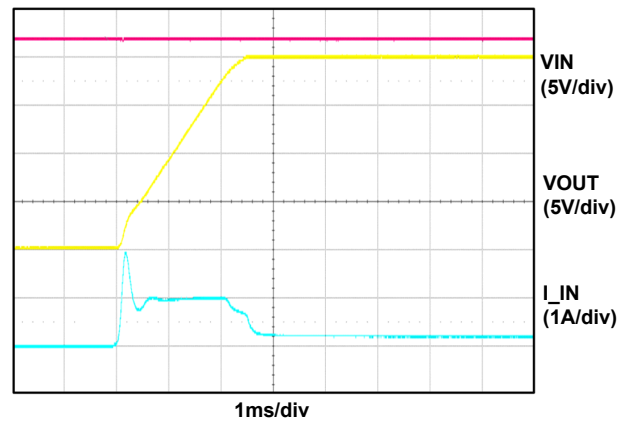

Figure 6. Soft Start Ramp (VIN = 20V)

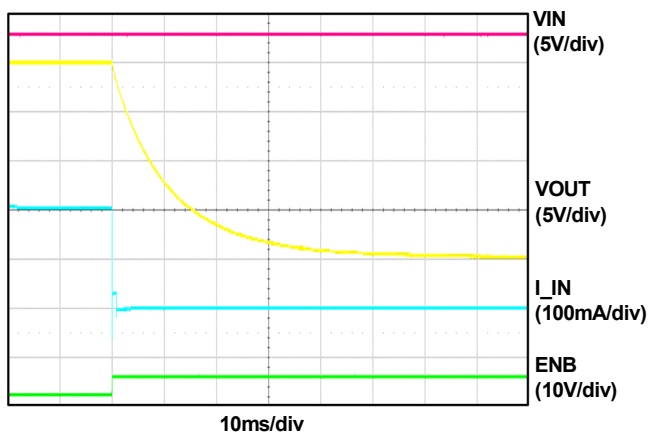

Figure 7. Shutdown (VIN = 5V)

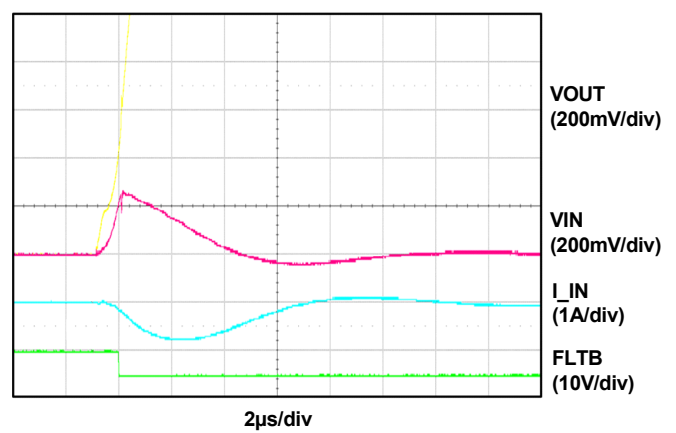

Figure 8. True Reverse Current Blocking (VIN = 5V)

Typical Characteristics (Continued)

$C_{IN} = 10\mu F$, $C_{OUT} = 120\mu F$, $R_{LOAD} = 100\Omega$, $C_{SS} = 5.6nF$, $OVP = GND$, $T_A = 25^\circ C$ unless otherwise specified.

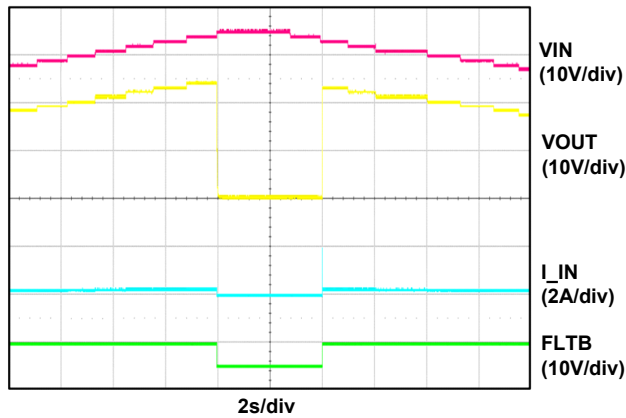

Figure 9. Over Voltage Protection (Option -01)

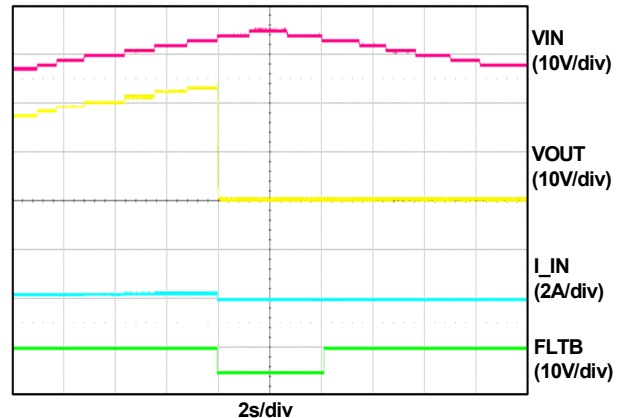

Figure 10. Over Voltage Protection (Option -02)

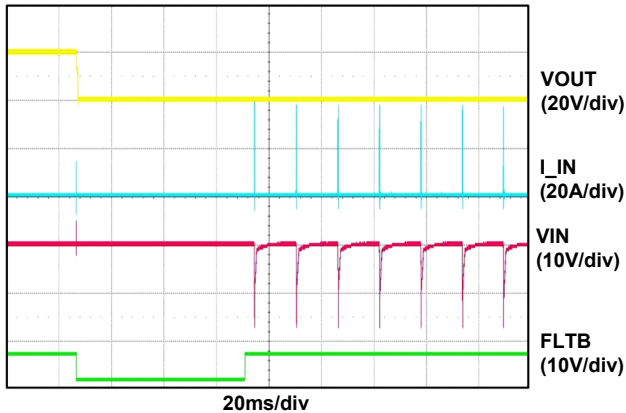

Figure 11. Short Circuit Response
($C_{SS} = 1nF$, No Load, Option -01)

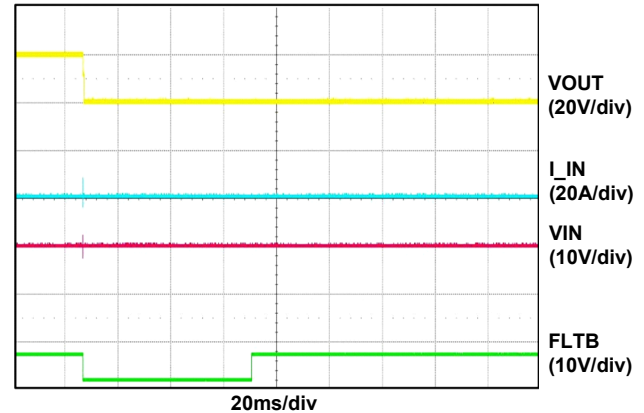

Figure 12. Short Circuit Response
($C_{SS} = 1nF$, No Load, Option -02)

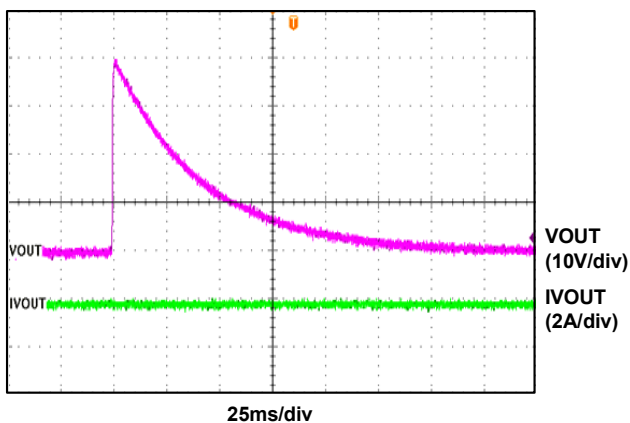

Figure 13. IEC 61000-4-5: 40V Surge Voltage
without Device

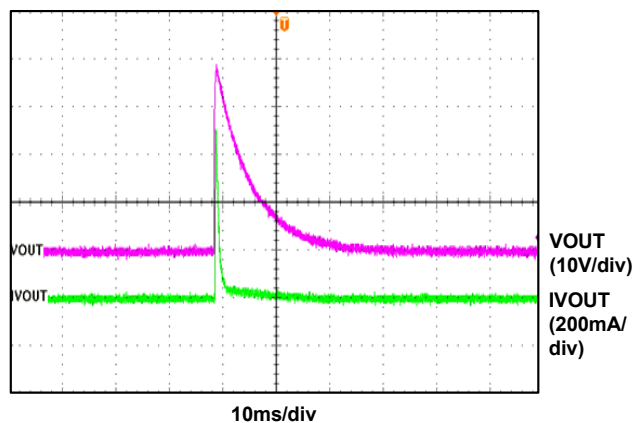

Figure 14. IEC 61000-4-5: 40V Surge Voltage
with Device (No Capacitor on VIN)

Typical Characteristics (Continued)

$T_A = 25^\circ\text{C}$, unless otherwise specified.

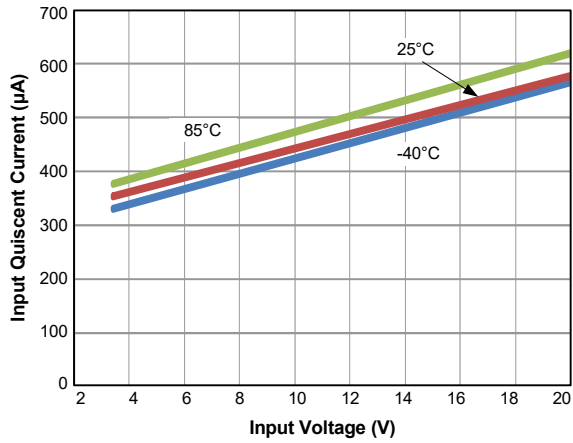

Figure 15. Quiescent Current vs. Input Voltage

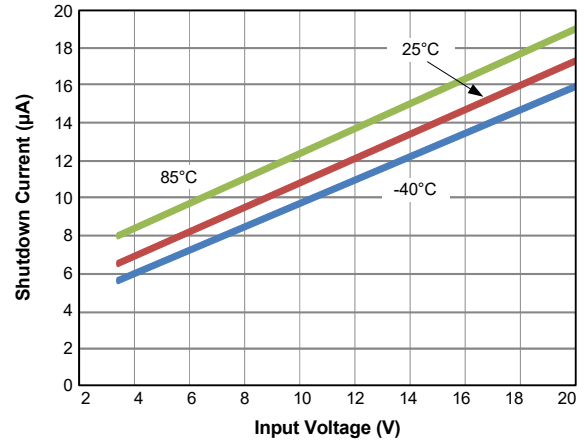

Figure 16. Shutdown Current vs. Input Voltage

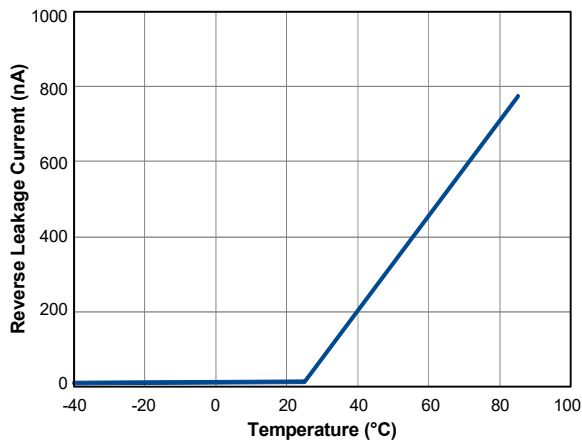

Figure 17. Reverse Leakage Current vs. Temperature

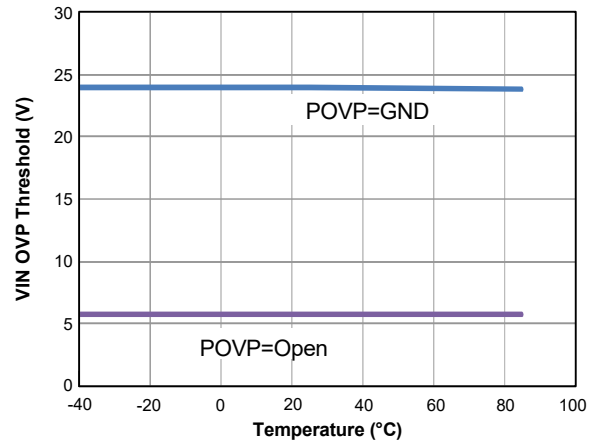

Figure 18. VIN OVP vs. Temperature

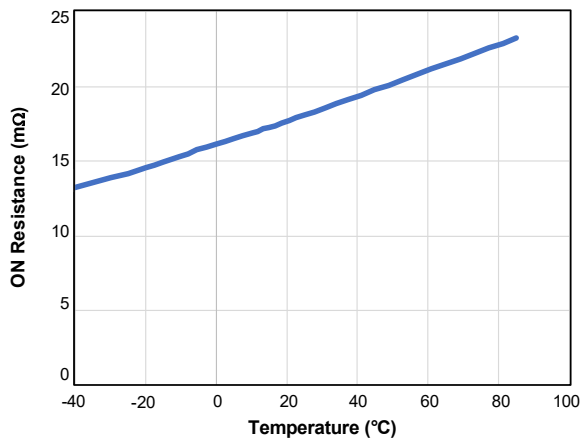

Figure 19. On Resistance vs. Temperature

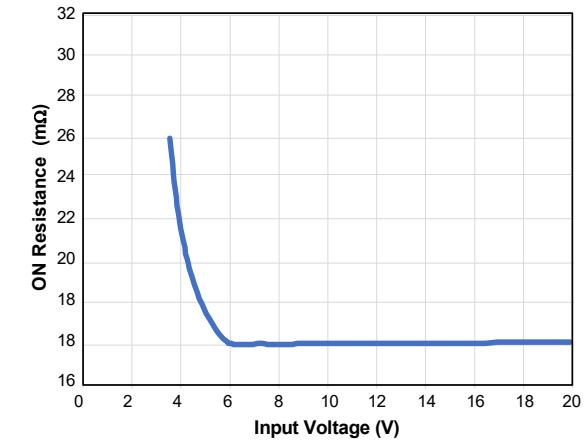

Figure 20. On Resistance vs. Input Voltage

Detailed Description

The AOZ1328DI is a high-side protection switch with adjustable soft-start, over-voltage and over-temperature protections. It is capable of operating from 3.4V to 22V and rated up to 9A.

The internal power switch consists of 2 back-to-back connected N-channel MOSFETs. When the switch is enabled, the overall resistance between VIN and VOUT is only 18mΩ typical, minimizing power loss and heat generation. The back-to-back configuration of MOSFETs completely isolates VIN and VOUT when the switch is turned off, preventing leakage between the two pins.

Power Delivery Capability

During start-up, the voltage at VOUT linearly ramps up to the VIN voltage over a period of time set by the soft-start time. This ramp time is referred to as the soft-start time and is typically in milliseconds. Figure 21 illustrates the soft-start condition and power dissipation.

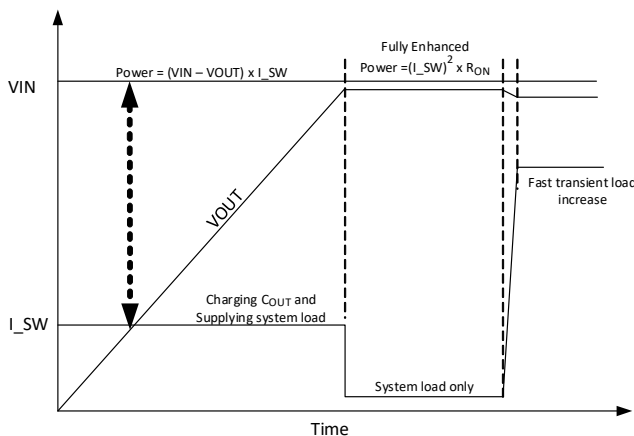

Figure 21. Soft Start Power Dissipation

During this soft-start time, there will be a large voltage across the power switch. Also, there will be current I_SW through the switch to charge the output capacitance. In addition, there may be load current to the downstream system as well. This total current is calculated as:

$$I_{SW} = C_{OUT} \left(\frac{dV_{OUT}}{dt} \right) + I_{SYS}$$

In the soft-start condition, the switch is operating in the linear mode, and power dissipation is high. The ability to handle this power is largely a function of the power MOSFET linear mode SOA and good package thermal performance (Rthj-c) as the soft-start ramp time is in milliseconds. Rthj-ambient, which is more a function of PCB thermal performance, doesn't play a role. With a high-reliability MOSFET as the power switch and

superior packaging technology, the AOZ1328DI is capable of dissipating this power. The power dissipated is:

$$Power\ Dissipation = I_{SW} \times (VIN - VOUT)$$

To calculate the average power dissipation during the soft-start period: ½ of the input voltage should be used as the output voltage will ramp towards the input voltage, as shown in Figure 21.

For example, if the output capacitance C_OUT is 10µF, the input voltage VIN is 20V, the soft-start time is 2ms, and there is an additional 1A of system current (I_SYS), then the average power being dissipated by the part is:

$$I_{SW} = 10\mu F \left(\frac{20V}{2ms} \right) + 1A = 1.1A$$

$$Average\ Power\ Dissipation = 1.1A \times \frac{20V}{2} = 11W$$

Referring to the SOA curve in Figure 22, the maximum power allowed for 2ms (DC) is 50W (2.5A x 20V or 5A x 10V). The AOZ1328DI power switch is robust enough to drive a large output capacitance with load in reasonable soft-start time.

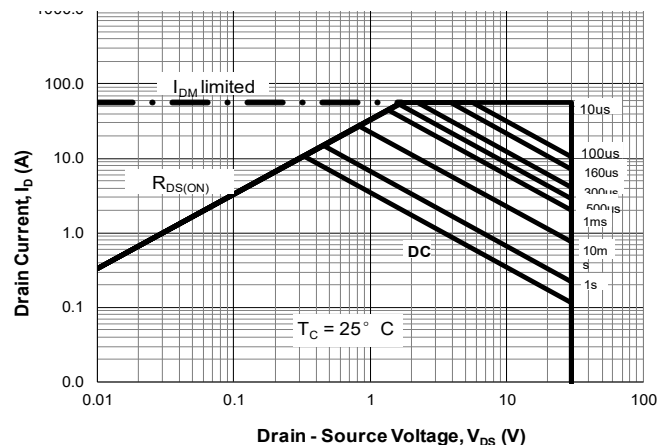

Figure 22. Safe Operating Area (SOA) Curves for Sink Power Switch

After soft-start is completed, the power switch is fully on, and it is at its lowest resistance. The power switch acts as a resistor. Under this condition, the power dissipation is much lower than the soft-start period. However, as this is a continuous current, a low on-resistance is required to minimize power dissipation. Attention must be paid to board layout so that losses dissipated in the sinking switch are dissipated to the PCB and hence the ambient. With a low on-resistance of 18mΩ, the AOZ1328DI

provides the most efficient power delivery without much resistive power dissipation.

While Type C power delivery is limited to 20V @ 5A or a 100W, many high-end laptops require peak currents far in excess of the 5A. While the thermal design current (TDC) for a CPU may be low, peak current (ICCmax in the case of Intel and EDP in the case of AMD) of many systems often 2 x thermal design current. These events are typical of short duration (<2ms) and low duty cycle, but they are important for system performance as a CPU/GPU capable of operating at several GHz can boost its compute power in those 2ms peak current events. The AOZ1328DI can handle such short, high current, transient pulses without any reliability degradation, thus enhancing the performance of high-end systems when plugged into the Type C adaptor. The shorter the pulse and the lower the duty cycle, the higher the pulse current that the part can sustain. The part has enough time to dissipate the heat generated from the pulse current with longer off-time, as shown in Figure 23. For example, AOZ1328DI can maintain 20A for 10ms with a duty cycle of 2%.

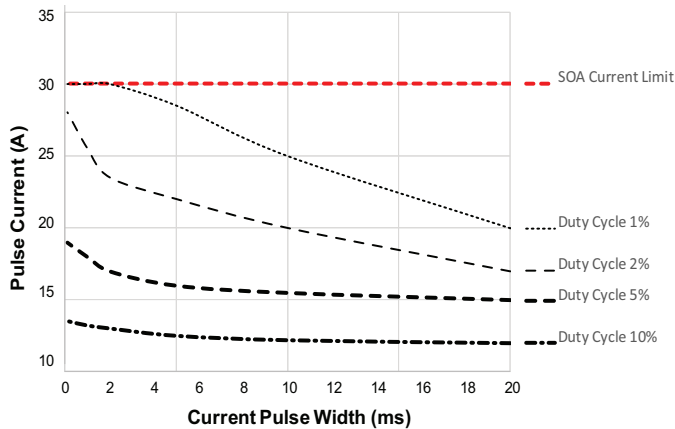

Figure 23. Pulsed Current Magnitude vs Duration for a Given Duty Cycle

Enable

The active-low ENB pin is the ON/OFF control for the power switch. The device is enabled when the ENB pin is low and the device is not in UVLO state. The ENB pin must be driven to a logic low or logic high state to guarantee operation. While disabled, the AOZ1328DI draws about 18µA supply current.

When a fault occurs for AOZ1328DI-02 latch-off version, toggle enable to restart the device and clear the fault indicator.

Input Under-Voltage Lockout (UVLO)

The internal circuitry of the AOZ1328DI is powered from VIN. The under-voltage lockout (UVLO) circuit of the

AOZ1328DI monitors the voltage at the input pin and only allows the power switches to turn on when VIN is higher than 3.4V. If VIN is below 3.4V, the device is in under-voltage lockout state.

Programmable Over-Voltage Protection (OVP)

The voltages at VIN pin are constantly monitored once the device is enabled. In case the voltage exceeds the programmed threshold, over-voltage protection is activated:

1. If the power switch is on, it will be turned off immediately to isolate VOUT from VIN
2. OVP will prevent power switch to be turned on if it is in off state.

In either case FLTB pin is pulled low to report the fault condition.

An external bias connected to POVP sets the over-voltage protection threshold. An internal 8µA current source biases the POVP pin. The voltage at the POVP pin is detected by comparators that set the OVP threshold based on the table below:

Table 1. OVP Setting by External Resistor

POVP Bias	OVP Threshold
GND	24V
open	5.8V

True Reverse Current Blocking (TRCB)

The AOZ1328DI immediately turns off the power switch upon detection of a VOUT that is 26mV higher than VIN. The FLTB pin will also be immediately pulled low to indicate the fault condition.

When the AOZ1328DI is first enabled or during each auto restart, power switch will be kept off if output voltage exceeds input voltage by 26mV.

Thermal Shutdown Protection

When the die temperature reaches 140°C the power switch is turned off. There is a 30°C hysteresis. Over-temperature fault is removed when die temperature drops below approximately 110°C.

Soft-Start Slew-Rate Control

When ENB pin is asserted low, the slew rate control circuitry applies voltage on the gate of the power switch in a manner such that the output voltage is ramped up linearly until it reaches input voltage level. The output ramp up time depends on the VIN and POVP setting and is programmed by an external soft-start capacitor (C_{SS}).

The following formula provides the estimated 10% to 90% ramp up time.

$$t_{SS} = \left(\frac{V_{VIN}}{V_{OVP}} \right) \times \left(\left(\frac{C_{SS}}{0.0023} \right) - 100 \right)$$

Where VIN and VOVP are in volts and CSS is in nF. tSS Value is provided in μs. CSS must be greater than 0.23nF.

For example, if VIN = 20V, VOVP = 24V and CSS = 2.7nF, the VOUT ramp up time is 895μs.

System Startup

The device is enabled when ENB ≤ 0.6V and VIN is higher than UVLO threshold. The OVP threshold is first selected by sensing POVP voltage. The device will then check if fault condition exist. When no fault exists, the power switch is turned on and VOUT is then ramped up, controlled by the soft-start till it reaches the input voltage.

During soft-start, in-rush current is limited by soft start.

Fault Protection

The AOZ1328DI offers protection against the following fault conditions: VIN over voltage, VOUT greater than VIN, and over temperature.

When the device is first enabled, the power switch is off and fault conditions are checked. If VIN is higher than the OVP threshold, or VOUT is higher than VIN by 26mV (typical), or the die temperature is higher than thermal shutdown threshold, the FLTB pin will be pulled low to flag the fault.

After the power switch turns on, the device continuously monitors all fault conditions. The switch is immediately turned off when over voltage, VOUT greater than VIN or over temperature is detected. FLTB pin will be subsequently pulled low.

Auto-restart vs. Latch-off

AOZ1328DI-01 (auto-restart version):

If the power switch is turned off due to fault protection, the device will try to restart 64ms (tREC) after the fault clears.

AOZ1328DI-02 (latch-off version):

The power switch keeps off even after the fault clears. The device can only be re-enabled by either toggling ENB pin or cycling the input power supply.

Input Capacitor Selection

The input capacitor prevents large voltage transients from appearing at the input, and provides the

instantaneous current needed each time the switch turns on to charge output capacitors and to limit input voltage drop. It is also to prevent high-frequency noise on the power line from passing through to the output. The input capacitor should be located as close to the pin as possible. A 10μF ceramic capacitor is recommended. The USB specification limits the capacitance on VBUS to a maximum of 10μF. Use this maximum value for noise immunity due to the system and cable plug/unplug transients.

Output Capacitor Selection

The output capacitor acts in a similar way. Also, the output capacitor has to supply enough current for a large load that it may encounter during system transient. This bulk capacitance must be large enough to supply fast transient load in order to prevent the output from dropping.

Power Dissipation Calculation

Use the following equation to calculate the power dissipation for normal load condition:

$$\text{Power Dissipated} = R_{ON} \times (I_{OUT})^2$$

Layout Guidelines

AOZ1328DI is a protection switch designed deliver high current. Layout is critical to remove the heat generated by this current. For the most efficient heat sinking, connect as much copper as possible to the exposed pad. The exposed pad is the common drain of the power switch which must be electrically isolated.

On the top layer expand the exposed pad island as much as possible for optimal thermal performance. The exposed pad copper plane must be electrically isolated. See example in Figure 24.

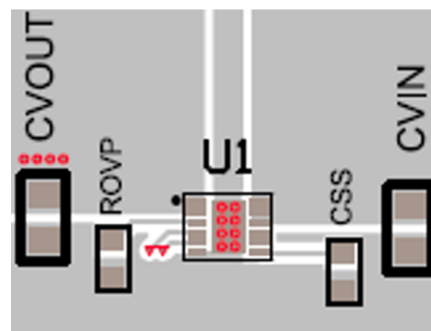

Figure 24. Top Layer Layout. Maximum Number of VIAs from Top Layer Exposed Pad to Inner Layer

There are two ways to create thermal islands on the inner layers. If the layer is flooded with a plane an isolated pad may be etched out as showed in Figure 25. If there are

no flooded planes then an isolated island may be created as showed in Figure 26. The more layers that have these electrically isolated thermal heat sink islands the better the thermal performance will be. Connect all isolated thermal island (top, inner layers and bottom) together with as many VIAs as possible.

On the bottom layer, similar to the inner layers, create an isolated thermal island. Typically, there is more area available on the bottom area for a larger thermal pad. The top and bottom layers have better thermal performance than the inner layers because they are exposed to the atmosphere. See example in Figure 27.

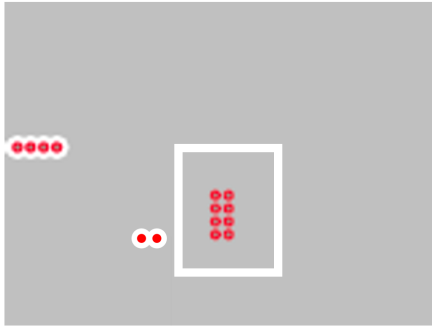

Figure 25. Inner Layer Layout. Create Electrically Isolated Thermal Island with Flooded Plane

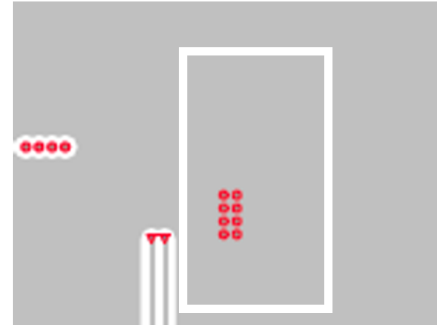

Figure 27. Bottom Layer Layout. Create a Large Electrically Isolated Thermal Pad.

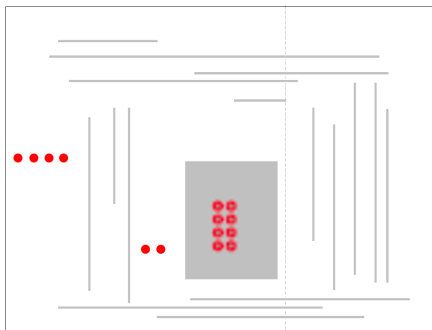
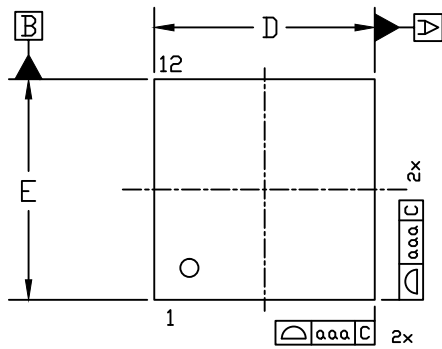
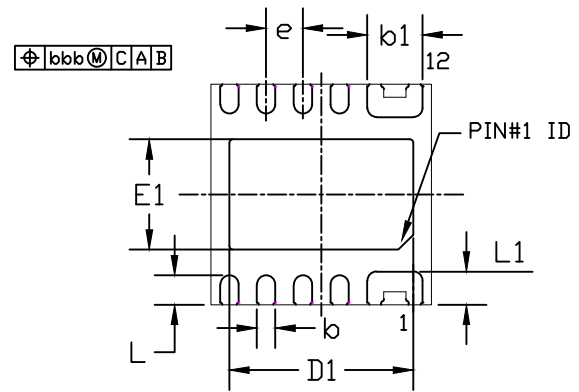

Figure 26. Inner Layer Layout. Create an Isolated Island With No Flooded Plane.

Package Dimensions, DFN3x3B-12L



TOP VIEW



BOTTOM VIEW

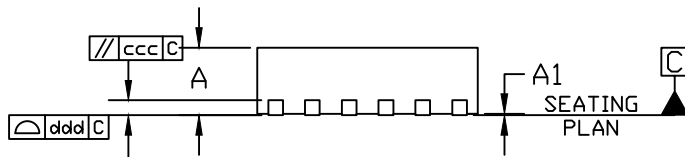

SIDE VIEW

RECOMMENDED LAND PATTERN

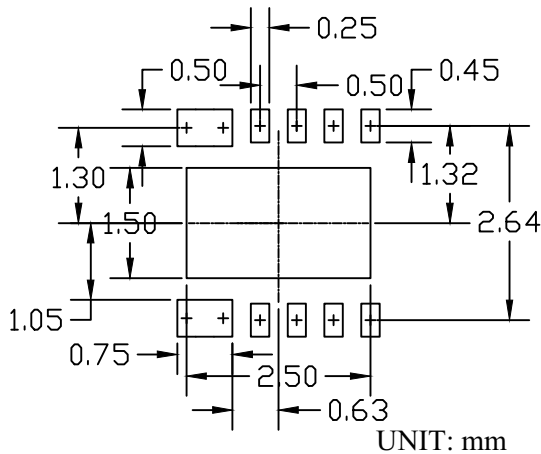

SYMBOLS	DIMENSIONS IN MILLIMETERS			DIMENSIONS IN INCHES		
	MIN	NOM	MAX	MIN	NOM	MAX
A	0.80	0.90	1.00	0.031	0.035	0.039
A1	0.00	0.02	0.05	0.000	0.001	0.002
b	0.20	0.25	0.30	0.008	0.010	0.012
b1	0.70	0.75	0.80	0.028	0.030	0.032
c	0.203BSC			0.008BSC		
D	3.00 BSC			0.118 BSC		
D1	2.40	2.50	2.60	0.094	0.098	0.102
E	3.00 BSC			0.118 BSC		
E1	1.40	1.50	1.60	0.055	0.059	0.063
e	0.50BSC			0.020BSC		
L	0.30	0.40	0.50	0.012	0.016	0.020
L1	0.35	0.45	0.55	0.014	0.018	0.022
aaa	0.15			0.006		
bbb	0.10			0.004		
ccc	0.10			0.004		
ddd	0.08			0.003		

NOTE

1. DIMENSIONING AND TOLERANCING CONFORM TO ASME Y14.5M-1994.
2. CONTROLLING DIMENSION IS MILLIMETER.
CONVERTED INCH DIMENSIONS ARE NOT NECESSARILY EXACT.
3. DIMENSION b APPLIES TO METALLIZED TERMINAL AND IS MEASURED BETWEEN 0.15mm. AND 0.30mm FROM THE TERMINAL TIP. IF THE TERMINAL HAS THE OPTIONAL RADIUS ON THE OTHER END OF THE TERMINAL, THE DIMENSION b SHOULD NOT BE MEASURED IN THAT RADIUS AREA.
4. COPLANARITY ddd APPLIES TO THE TERMINALS AND ALL OTHER BOTTOM SURFACE

Tape and Reel Dimensions, DFN3x3B-12L

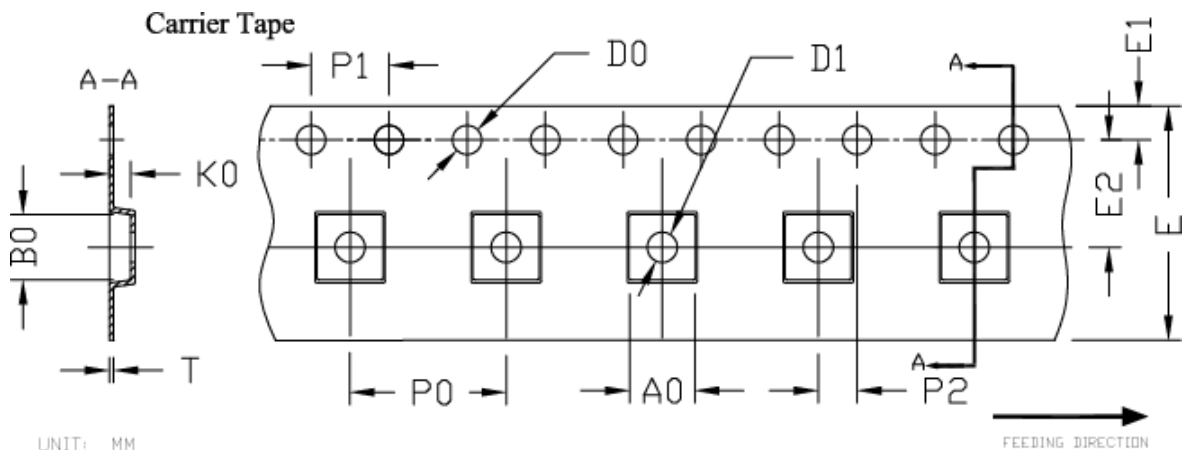

UNIT: MM

FEEDING DIRECTION

PACKAGE	A0	B0	K0	D0	D1	E	E1	E2	P0	P1	P2	T
DFN3x3_EP	3.40 ±0.10	3.35 ±0.10	1.10 ±0.10	1.50 +0.10 -0	1.50 +0.10 -0	12.00 ±0.30	1.75 ±0.10	5.50 ±0.05	8.00 ±0.10	4.00 ±0.10	2.00 ±0.05	0.30 ±0.05

REEL

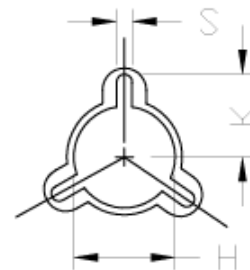
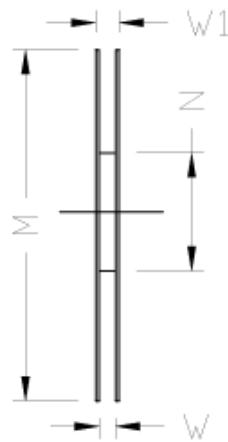
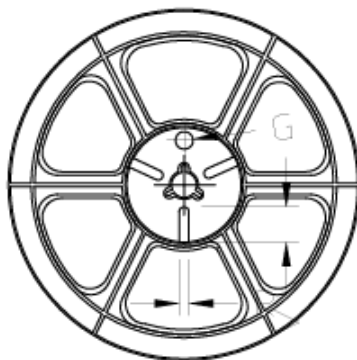

UNIT: MM

TAPE SIZE	REEL SIZE	M	N	W	W1	H	K	S	G	R	V
12 mm	φ330	φ330.00 ±0.50	φ97.00 ±0.10	13.00 ±0.30	17.40 ±1.00	φ13.00 +0.50 -0.20	10.60	2.00 ±0.50	---	---	---

Tape and Reel Dimensions, DFN3x3B-12L

TAPE
Leader / Trailer & Orientation

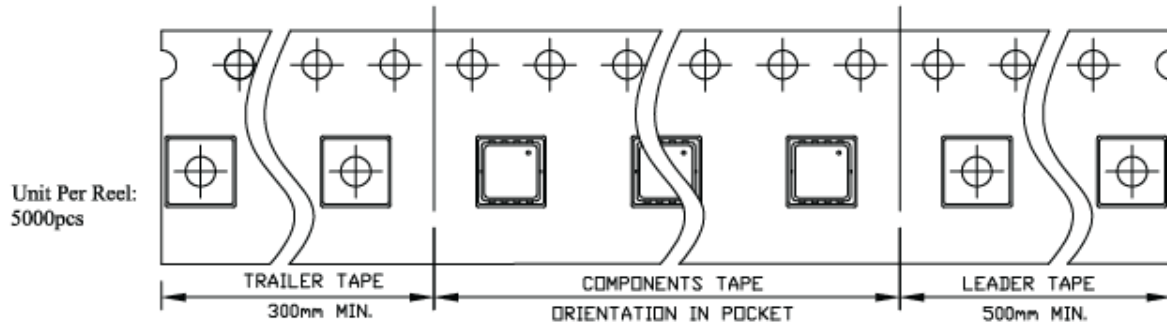

Part Marking

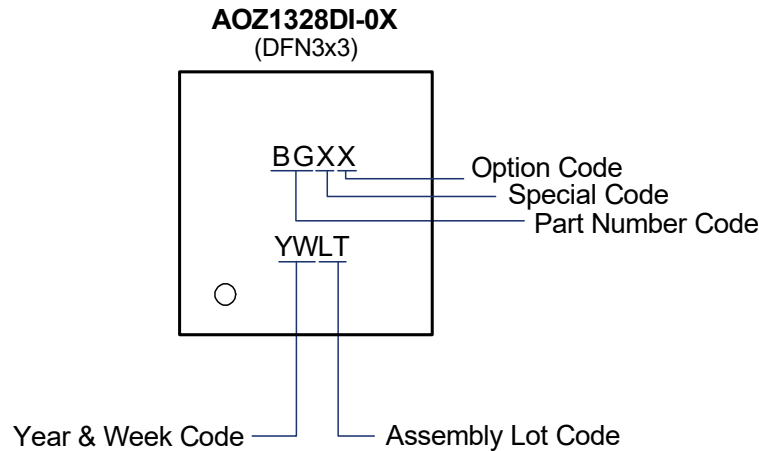

Part Number	Fault Recovery	Code
AOZ1328DI-01	Auto-Start	BG01
AOZ1328DI-02	Latch-Off	BG02

LEGAL DISCLAIMER

Applications or uses as critical components in life support devices or systems are not authorized. AOS does not assume any liability arising out of such applications or uses of its products. AOS reserves the right to make changes to product specifications without notice. It is the responsibility of the customer to evaluate suitability of the product for their intended application. Customer shall comply with applicable legal requirements, including all applicable export control rules, regulations and limitations.

AOS' products are provided subject to AOS' terms and conditions of sale which are set forth at:
http://www.aosmd.com/terms_and_conditions_of_sale

LIFE SUPPORT POLICY

ALPHA AND OMEGA SEMICONDUCTOR PRODUCTS ARE NOT AUTHORIZED FOR USE AS CRITICAL COMPONENTS IN LIFE SUPPORT DEVICES OR SYSTEMS.

As used herein:

1. Life support devices or systems are devices or systems which, (a) are intended for surgical implant into the body or (b) support or sustain life, and (c) whose failure to perform when properly used in accordance with instructions for use provided in the labeling, can be reasonably expected to result in a significant injury of the user.
2. A critical component in any component of a life support, device, or system whose failure to perform can be reasonably expected to cause the failure of the life support device or system, or to affect its safety or effectiveness.