

General Description

The AOZ8310DI is a series of one-line, high-power transient voltage suppressor designed to protect power rail/bus from surge and ESD events, with an operating voltage range from 2.5V to 36V.

This device incorporates one unidirectional TVS diode in an ultra-small 1.6mm x 1.0mm DFN package. It may be used to meet the ESD immunity requirements of IEC 61000-4-2, Level 4 ($\pm 15\text{kV}$ air, $\pm 8\text{kV}$ contact discharge).

The AOZ8310DI comes in an RoHS compliant package and is rated over a -40°C to $+125^{\circ}\text{C}$ ambient temperature range.

Features

- Surge protection for power rail
- IEC 61000-4-5 8/20 μs 22-85A
- IEC 61000-4-2 (ESD) $\pm 30\text{kV}$ (air and contact)
- Human body model (HBM) $\pm 30\text{kV}$
- IEC 61000-4-4 (EFT) 80A (5/50ns)
- Peak pulse power 1100W to 1500W
- Operating voltage: 2.5V, 5V, 8V, 9V, 12V, 18V, 20V, 26V, 36V
- Green product

Applications

- USB voltage bus
- Battery protection
- Mobile devices
- Screen panels
- Other power rails



Typical Application

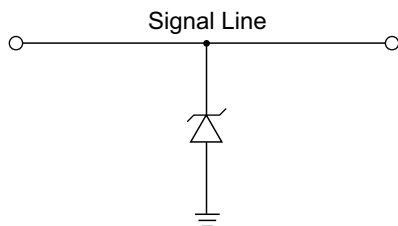

Unidirection Protection of Single Line

Pin Configuration

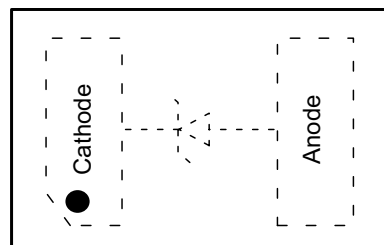

DFN1.6x1.0_2L

Ordering Information

Part Number	Ambient Temperature Range	Package	Environmental
AOZ8310DI-02	-40°C to +125°C	1.6mm x 1.0mm DFN-2L	Green Product
AOZ8310DI-05			
AOZ8310DI-08			
AOZ8310DI-09			
AOZ8310DI-12			
AOZ8310DI-18			
AOZ8310DI-20			
AOZ8310DI-26			
AOZ8310DI-36			



AOS Green Products use reduced levels of Halogens, and are also RoHS compliant.

Please visit www.aosmd.com/media/AOSGreenPolicy.pdf for additional information.

Absolute Maximum Ratings

Exceeding the Absolute Maximum ratings may damage the device.

Parameter	Rating
VP-VN	2.5V to 36V
Peak Pulse Current (I_{PP}), $t_P = 8/20\mu s$	22A to 85A
Peak Pulse Power (P_{PP}), $t_P = 8/20\mu s$	1100W to 1500W
Storage Temperature (T_S)	-65°C to +150°C
ESD Rating per IEC61000-4-2, Contact ⁽¹⁾	±30kV
ESD Rating per IEC61000-4-2, Air ⁽¹⁾	±30kV
ESD Rating per Human Body Model ⁽²⁾	±30kV

Notes:

1. IEC 61000-4-2 discharge with $C_{Discharge} = 150pF$, $R_{Discharge} = 330\Omega$.

2. Human Body Discharge per MIL-STD-883, Method 3015 $C_{Discharge} = 100pF$, $R_{Discharge} = 1.5k\Omega$.

Maximum Operating Ratings

Parameter	Rating
Junction Temperature (T_J)	-40°C to +125°C

Electrical Characteristics

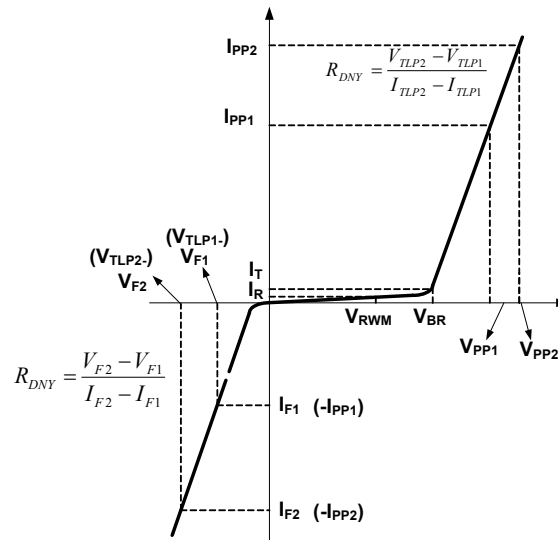

$T_A = 25^\circ\text{C}$ unless otherwise specified.

Symbol	Parameter	Condition	Min.	Typ.	Max.	Units
AOZ8310DI-02						
V_{RWM}	Reverse Working Voltage	I/O Pin-to-Ground			2.5	V
V_{BR}	Reverse Breakdown Voltage	$I_T = 1\text{mA}$, I/O Pin-to-Ground	2.8	3.3	5	V
I_R	Reverse Leakage Current	Max. V_{RWM} , I/O Pin-to-Ground		100	1000	nA
I_{PP}	Peak Pulse Current	IEC61000-4-5, 8/20 μs , I/O Pin-to-Ground			75	A
V_{CL}	Clamping Voltage ⁽³⁾ (100ns Transmission Line Pulse, I/O Pin-to-Ground)	$I_{TLP} = 1\text{A}$ $I_{TLP} = -1\text{A}$		4.5 -1	6 -2	V
		$I_{TLP} = 30\text{A}$ $I_{TLP} = -30\text{A}$		5.5 -3.5	7.5 -5	V
	Clamping Voltage ⁽³⁾ (IEC61000-4-5 8/20 μs , I/O Pin-to-Ground)	$I_{PP} = 10\text{A}$ $I_{PP} = -10\text{A}$		5.5 -2.5	7.5 -4	V
		$I_{PP} = 75\text{A}$ $I_{PP} = -75\text{A}$		13 -10	15 -12	V
R_{DNY}	Dynamic Resistance ⁽³⁾	$I_{TLP} = 1\text{A to } 30\text{A}$ $I_{TLP} = -1\text{A to } -30\text{A}$		0.05 0.1		Ω
P_{PP}	Peak Pulse Power	IEC61000-4-5, 8/20 μs , I/O Pin-to-Ground			1100	W
C_J	Junction Capacitance	$V_{I/O} = 0\text{V}$, $f = 1\text{MHz}$, I/O Pin-to-Ground		100		pF

Symbol	Parameter	Condition	Min.	Typ.	Max.	Units
AOZ8310DI-05						
V _{RWM}	Reverse Working Voltage	I/O Pin-to-Ground			5	V
V _{BR}	Reverse Breakdown Voltage	I _T = 1mA, I/O Pin-to-Ground	6	7.5	8.5	V
I _R	Reverse Leakage Current	Max. V _{RWM} , I/O Pin-to-Ground		100	1000	nA
I _{PP}	Peak Pulse Current	IEC61000-4-5, 8/20μs, I/O Pin-to-Ground			85	A
V _{CL}	Clamping Voltage ⁽³⁾ (100ns Transmission Line Pulse, I/O Pin-to-Ground)	I _{TLP} = 1A I _{TLP} = -1A		8 -1	9.5 -2	V
		I _{TLP} = 30A I _{TLP} = -30A		9.5 -3.5	11 -5	V
	Clamping Voltage ⁽³⁾ (IEC61000-4-5 8/20μs, I/O Pin-to- Ground)	I _{PP} = 20A I _{PP} = -20A		9.5 -2.5	11 -4	V
		I _{PP} = 85A I _{PP} = -85A		14.3 -6	16 -8	V
R _{DNY}	Dynamic Resistance ⁽³⁾	I _{TLP} = 1A to 30A I _{TLP} = -1A to -30A		0.05 0.09		Ω
P _{PP}	Peak Pulse Power	IEC61000-4-5, 8/20μs, I/O Pin-to-Ground			1500	W
C _J	Junction Capacitance	V _{I/O} = 0V, f = 1MHz, I/O Pin-to-Ground		675		pF
AOZ8310DI-08						
V _{RWM}	Reverse Working Voltage	I/O Pin-to-Ground			8	V
V _{BR}	Reverse Breakdown Voltage	I _T = 1mA, I/O Pin-to-Ground	9	10	12	V
I _R	Reverse Leakage Current	Max. V _{RWM} , I/O Pin-to-Ground		10	100	nA
I _{PP}	Peak Pulse Current	IEC61000-4-5, 8/20μs, I/O Pin-to-Ground			70	A
V _{CL}	Clamping Voltage ⁽³⁾ (100ns Transmission Line Pulse, I/O Pin-to-Ground)	I _{TLP} = 1A I _{TLP} = -1A		10.5 -0.9	12 -1.5	V
		I _{TLP} = 30A I _{TLP} = -30A		12 -3.7	13.5 -5	V
	Clamping Voltage ⁽³⁾ (IEC61000-4-5 8/20μs, I/O Pin-to- Ground)	I _{PP} = 10A I _{PP} = -10A		12 -2.4	14 -4	V
		I _{PP} = 70A I _{PP} = -70A		21 -9	24 -11	V
R _{DNY}	Dynamic Resistance ⁽³⁾	I _{TLP} = 1A to 30A I _{TLP} = -1A to -30A		0.05 0.1		Ω
P _{PP}	Peak Pulse Power	IEC61000-4-5, 8/20μs, I/O Pin-to-Ground			1500	W
C _J	Junction Capacitance	V _{I/O} = 0V, f = 1MHz, I/O Pin-to-Ground		425		pF

Symbol	Parameter	Condition	Min.	Typ.	Max.	Units
AOZ8310DI-09						
V _{RWM}	Reverse Working Voltage	I/O Pin-to-Ground			9	V
V _{BR}	Reverse Breakdown Voltage	I _T = 1mA, I/O Pin-to-Ground	10	11	13	V
I _R	Reverse Leakage Current	Max. V _{RWM} , I/O Pin-to-Ground		10	100	nA
I _{PP}	Peak Pulse Current	IEC61000-4-5, 8/20μs, I/O Pin-to-Ground			65	A
V _{CL}	Clamping Voltage ⁽³⁾ (100ns Transmission Line Pulse, I/O Pin-to-Ground)	I _{TLP} = 1A I _{TLP} = -1A		11.5 -0.9	13 -1.5	V
		I _{TLP} = 30A I _{TLP} = -30A		13.3 -3.7	15 -5	V
	Clamping Voltage ⁽³⁾ (IEC61000-4-5 8/20μs, I/O Pin-to- Ground)	I _{PP} = 10A I _{PP} = -10A		13.5 -2.4	15 -4.5	V
		I _{PP} = 65A I _{PP} = -65A		21.5 -8.5	24 -10.5	V
R _{DNY}	Dynamic Resistance ⁽³⁾	I _{TLP} = 1A to 30A I _{TLP} = -1A to -30A		0.05 0.1		Ω
P _{PP}	Peak Pulse Power	IEC61000-4-5, 8/20μs, I/O Pin-to-Ground			1500	W
C _J	Junction Capacitance	V _{I/O} = 0V, f = 1MHz, I/O Pin-to-Ground		385		pF
AOZ8310DI-12						
V _{RWM}	Reverse Working Voltage	I/O Pin-to-Ground			12	V
V _{BR}	Reverse Breakdown Voltage	I _T = 1mA, I/O Pin-to-Ground	13.2	15	17	V
I _R	Reverse Leakage Current	Max. V _{RWM} , I/O Pin-to-Ground		5	100	nA
I _{PP}	Peak Pulse Current	IEC61000-4-5, 8/20μs, I/O Pin-to-Ground			45	A
V _{CL}	Clamping Voltage ⁽³⁾ (100ns Transmission Line Pulse, I/O Pin-to-Ground)	I _{TLP} = 1A I _{TLP} = -1A		15.5 -0.9	18 -1.5	V
		I _{TLP} = 30A I _{TLP} = -30A		17 -3.5	19 -5	V
	Clamping Voltage ⁽³⁾ (IEC61000-4-5 8/20μs, I/O Pin-to- Ground)	I _{PP} = 10A I _{PP} = -10A		18 -2.4	21 -4.5	V
		I _{PP} = 45A I _{PP} = -45A		26 -6.8	30 -8.5	V
R _{DNY}	Dynamic Resistance ⁽³⁾	I _{TLP} = 1A to 30A I _{TLP} = -1A to -30A		0.05 0.1		Ω
P _{PP}	Peak Pulse Power	IEC61000-4-5, 8/20μs, I/O Pin-to-Ground			1500	W
C _J	Junction Capacitance	V _{I/O} = 0V, f = 1MHz, I/O Pin-to-Ground		275		pF

Symbol	Parameter	Condition	Min.	Typ.	Max.	Units
AOZ8310DI-18						
V _{RWM}	Reverse Working Voltage	I/O Pin-to-Ground			18	V
V _{BR}	Reverse Breakdown Voltage	I _T = 1mA, I/O Pin-to-Ground	19	21.5	24	V
I _R	Reverse Leakage Current	Max. V _{RWM} , I/O Pin-to-Ground		10	100	nA
I _{PP}	Peak Pulse Current	IEC61000-4-5, 8/20μs, I/O Pin-to-Ground			35	A
V _{CL}	Clamping Voltage ⁽³⁾ (100ns Transmission Line Pulse, I/O Pin-to-Ground)	I _{TLP} = 1A I _{TLP} = -1A		22 -1	24 -2	V
		I _{TLP} = 30A I _{TLP} = -30A		26 -4	29 -6	V
	Clamping Voltage ⁽³⁾ (IEC61000-4-5 8/20μs, I/O Pin-to- Ground)	I _{PP} = 10A I _{PP} = -10A		25 -2.5	29 -4.5	V
		I _{PP} = 35A I _{PP} = -35A		35 -6	39 -8	V
R _{DNY}	Dynamic Resistance ⁽³⁾	I _{TLP} = 1A to 30A I _{TLP} = -1A to -30A		0.1 0.1		Ω
P _{PP}	Peak Pulse Power	IEC61000-4-5, 8/20μs, I/O Pin-to-Ground			1200	W
C _J	Junction Capacitance	V _{I/O} = 0V, f = 1MHz, I/O Pin-to-Ground		200		pF
AOZ8310DI-20						
V _{RWM}	Reverse Working Voltage	I/O Pin-to-Ground			20	V
V _{BR}	Reverse Breakdown Voltage	I _T = 1mA, I/O Pin-to-Ground	22	25	28	V
I _R	Reverse Leakage Current	Max. V _{RWM} , I/O Pin-to-Ground		2	100	nA
I _{PP}	Peak Pulse Current	IEC61000-4-5, 8/20μs, I/O Pin-to-Ground			32	A
V _{CL}	Clamping Voltage ⁽³⁾ (100ns Transmission Line Pulse, I/O Pin-to-Ground)	I _{TLP} = 1A I _{TLP} = -1A		25.5 -0.9	28 -1.5	V
		I _{TLP} = 30A I _{TLP} = -30A		29 -3.5	32 -5	V
	Clamping Voltage ⁽³⁾ (IEC61000-4-5 8/20μs, I/O Pin-to- Ground)	I _{PP} = 5A I _{PP} = -5A		28 -2	31 -4	V
		I _{PP} = 32A I _{PP} = -32A		40 -5.5	44 -7.5	V
R _{DNY}	Dynamic Resistance ⁽³⁾	I _{TLP} = 1A to 30A I _{TLP} = -1A to -30A		0.12 0.1		Ω
P _{PP}	Peak Pulse Power	IEC61000-4-5, 8/20μs, I/O Pin-to-Ground			1200	W
C _J	Junction Capacitance	V _{I/O} = 0V, f = 1MHz, I/O Pin-to-Ground		165		pF

Symbol	Parameter	Condition	Min.	Typ.	Max.	Units
AOZ8310DI-26						
V _{RWM}	Reverse Working Voltage	I/O Pin-to-Ground			26	V
V _{BR}	Reverse Breakdown Voltage	I _T = 1mA, I/O Pin-to-Ground	28	31	35	V
I _R	Reverse Leakage Current	Max. V _{RWM} , I/O Pin-to-Ground		1	100	nA
I _{PP}	Peak Pulse Current	IEC61000-4-5, 8/20μs, I/O Pin-to-Ground			25	A
V _{CL}	Clamping Voltage ⁽³⁾ (100ns Transmission Line Pulse, I/O Pin-to-Ground)	I _{TLP} = 1A I _{TLP} = -1A		32 -0.9	35 -1.5	V
		I _{TLP} = 30A I _{TLP} = -30A		45 -4.5	50 -5	V
	Clamping Voltage ⁽³⁾ (IEC61000-4-5 8/20μs, I/O Pin-to- Ground)	I _{PP} = 5A I _{PP} = -5A		36 -2	40 -4	V
		I _{PP} = 25A I _{PP} = -25A		50 -5.5	55 -7.5	V
R _{DNY}	Dynamic Resistance ⁽³⁾	I _{TLP} = 1A to 25A I _{TLP} = -1A to -25A		0.45 -0.12		Ω
P _{PP}	Peak Pulse Power	IEC61000-4-5, 8/20μs, I/O Pin-to-Ground			1200	W
C _J	Junction Capacitance	V _{I/O} = 0V, f = 1MHz, I/O Pin-to-Ground		150		pF
AOZ8310DI-36						
V _{RWM}	Reverse Working Voltage	I/O Pin-to-Ground			36	V
V _{BR}	Reverse Breakdown Voltage	I _T = 1mA, I/O Pin-to-Ground	37	39	44	V
I _R	Reverse Leakage Current	Max. V _{RWM} , I/O Pin-to-Ground		10	100	nA
I _{PP}	Peak Pulse Current	IEC61000-4-5, 8/20μs, I/O Pin-to-Ground			22	A
V _{CL}	Clamping Voltage ⁽³⁾ (100ns Transmission Line Pulse, I/O Pin-to-Ground)	I _{TLP} = 1A I _{TLP} = -1A		43 -1	47 -2	V
		I _{TLP} = 30A I _{TLP} = -30A		52 -3.5	56 -5	V
	Clamping Voltage ⁽³⁾ (IEC61000-4-5 8/20μs, I/O Pin-to- Ground)	I _{PP} = 2A I _{PP} = -2A		45 -1.3	48 -2	V
		I _{PP} = 22A I _{PP} = -22A		72 -4.3	77 -7	V
R _{DNY}	Dynamic Resistance ⁽³⁾	I _{TLP} = 1A to 30A I _{TLP} = -1A to -30A		0.28 0.1		Ω
P _{PP}	Peak Pulse Power	IEC61000-4-5, 8/20μs, I/O Pin-to-Ground			1500	W
C _J	Junction Capacitance	V _{I/O} = 0V, f = 1MHz, I/O Pin-to-Ground		130		pF

Note:

3. These specifications are guaranteed by design and characterization.

Typical Characteristics

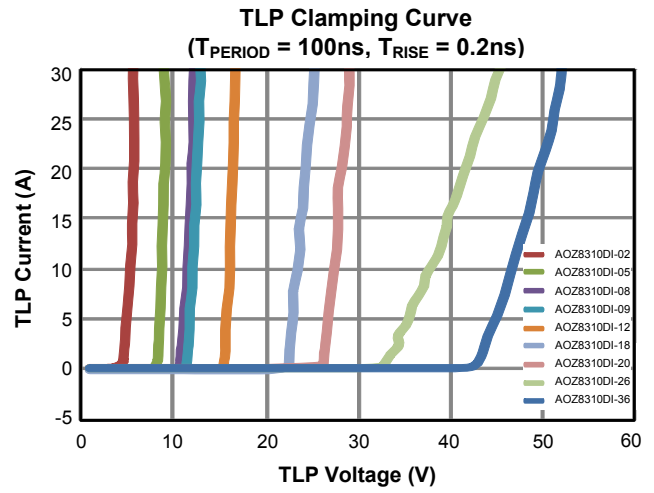
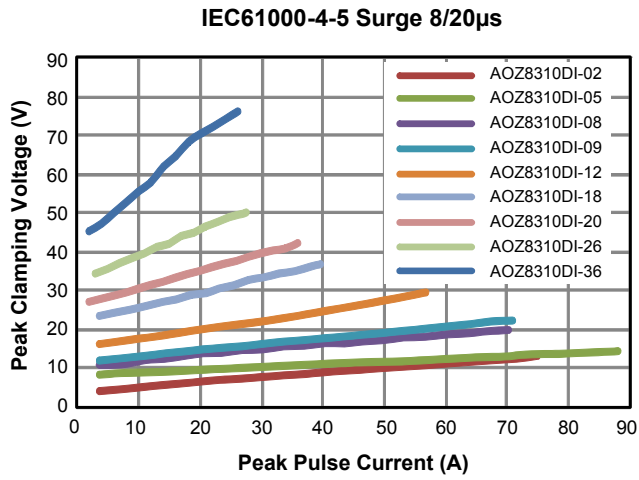

Package Dimensions, DFN1.6x1.0-2L, EPS_S

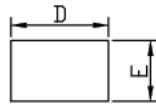

TOP VIEW



SIDE VIEW

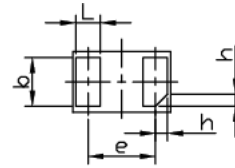

BOTTOM VIEW

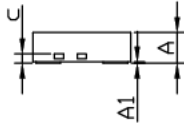

SIDE VIEW

RECOMMENDED LAND PATTERN

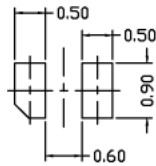

SYMBOLS	DIMENSIONS IN MILLIMETERS			DIMENSIONS IN INCHES		
	MIN	NOM	MAX	MIN	NOM	MAX
A	0.45	0.50	0.55	0.018	0.020	0.022
A1	---	0.02	0.05	----	0.001	0.002
b	0.75	0.80	0.85	0.030	0.031	0.033
c	0.10	0.15	0.20	0.004	0.006	0.008
D	1.55	1.60	1.65	0.061	0.063	0.065
e	1.10 BSC			0.043 BSC		
E	0.95	1.00	1.05	0.037	0.039	0.041
L	0.35	0.40	0.45	0.014	0.016	0.018
h	0.15	0.20	0.25	0.006	0.008	0.010

UNIT: mm

NOTE

1. CONTROLLING DIMENSION IS MILLIMETER.
CONVERTED INCH DIMENSIONS ARE NOT NECESSARILY EXACT.
2. TOLERANCE :±0.05 UNLESS OTHERWISE SPECIFIED.
3. RADIUS ON ALL CORNER ARE 0.152 MAX., UNLESS OTHERWISE SPECIFIED.
4. PACKAGE WARPAGE: 0.012 MAX.
5. NO ANY PLASTIC FLASH ALLOWED ON THE TOP AND BOTTOM LEAD SURFACE.
6. PAD PLANARITY: ±0.102
7. CRACK BETWEEN PLASTIC BODY AND LEAD IS NOT ALLOWED.

Tape and Reel Dimensions, DFN1.6x1.0-2L, EPS_S

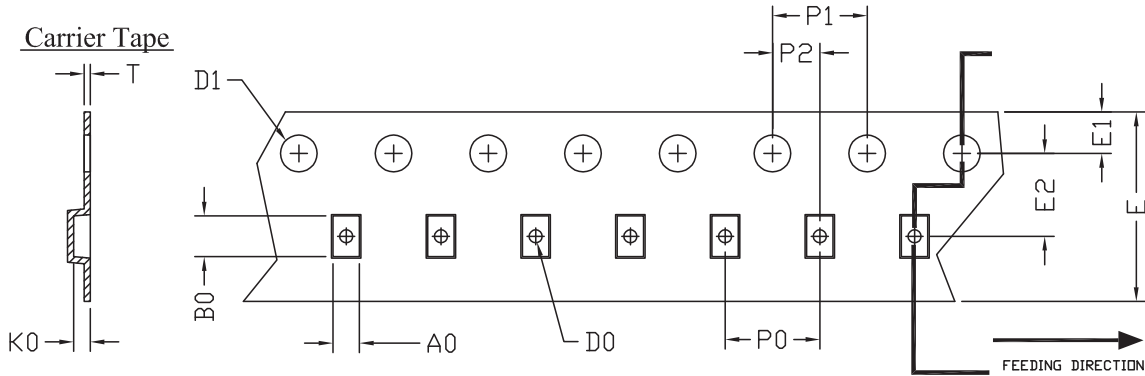

UNIT: MM

PACKAGE	A0	B0	K0	D0	D1	E	E1	E2	P0	P1	P2	T
DFN1.6x1.0	1.07	1.67	0.65	0.40	1.45	7.80	1.75	3.50	4.00	4.00	2.00	0.18
DFN1.6x0.8	~1.35	~1.90	~0.90	~0.60	~1.65	~8.30	±0.10	±0.05	±0.10	±0.10	±0.05	~0.30
DFN1.45x1.0												

Reel

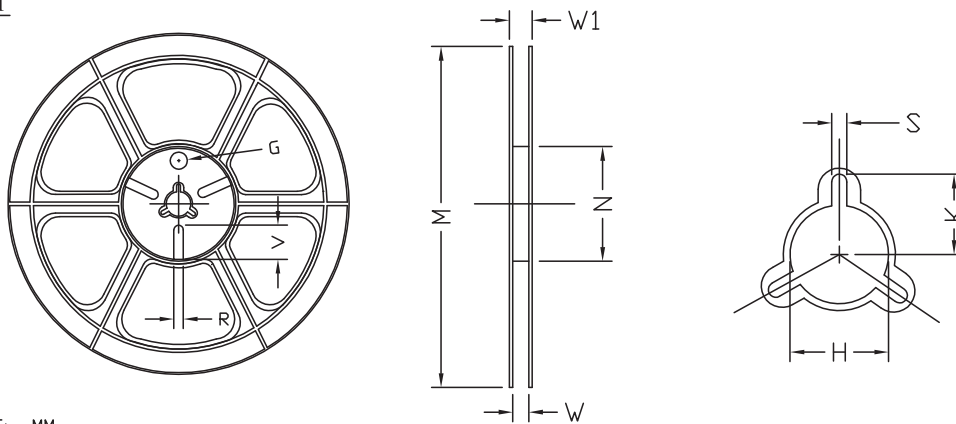

UNIT: MM

TAPE SIZE	REEL SIZE	M	N	W	W1	H	K	S	G	R	V
8 mm	φ178	φ178 ±1.0	φ52.0 ±1.0	9.0 ±0.5	N/A	φ13.0 ^{+0.5} -0.2	10.25 ±0.2	2.40 ±0.10	φ9.8	N/A	N/A

Tape

Leader / Trailer
& Orientation

Unit Per Reel:
3000pcs

