

General Description

The AOZ8351DI-04 is a 1-channel unidirectional high surge transient voltage suppressor designed to protect power rails such as battery and Vbus from damaging ESD or surge events.

This device consists of a unidirectional TVS diode in a single package. During transient events, the diode directs the transient to either the positive side of the power supply line or to ground.

The AOZ8351DI-04 provides a typical line-to-ground capacitance of 1200 pF and low clamping voltage making it ideally suited for power rail protection in mobile and computing devices.

The AOZ8351DI-04 comes in a RoHS compliant and Halogen Free 2.0 mm x 1.25 mm x 0.5 mm package and is rated for -40°C to +125°C junction temperature range.

Features

- ESD protection for high-speed data lines:
 - IEC 61000-4-2 (ESD immunity):
 - Air discharge: ± 30 kV
 - Contact discharge: ± 30 kV
 - IEC61000-4-5 (Lightning, 8/20 μ s): 160 A
- Capacitance between I/O to GND: 1200 pF
- Low clamping voltage
- Reverse Working Voltage: 4.8 V

Applications

- Battery
- Mobile devices
- Notebook computers



Typical Application

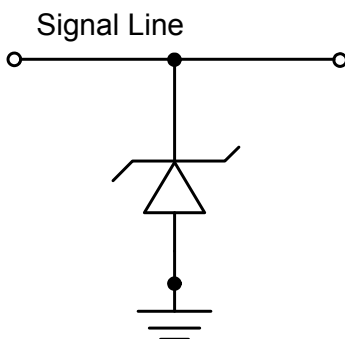

Pin Configuration

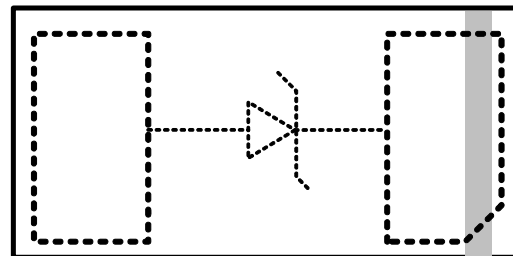

DFN2.0x1.25A_2L

Ordering Information

Part Number	Ambient Temperature Range	Package	Environmental
AOZ8351DI-04	-40°C to +125°C	DFN2.0x1.25A-2L	Green Product



AOS Green Products use reduced levels of Halogens, and are also RoHS compliant. Please visit www.aosmd.com/media/AOSGreenPolicy.pdf for additional information.

Absolute Maximum Ratings

Exceeding the Absolute Maximum ratings may damage the device.

Parameter	Rating
Storage Temperature (T _S)	-65°C to +150°C
ESD Rating per IEC61000-4-2, contact ⁽¹⁾	±30kV
ESD Rating per IEC61000-4-2, air ⁽¹⁾	±30kV
8/20µs Surge IEC61000-4-5	±160A

Notes:

- IEC 61000-4-2 discharge with C_{Discharge} = 150pF, R_{Discharge} = 330Ω.
- Human Body Discharge per MIL-STD-883, Method 3015 C_{Discharge} = 100pF, R_{Discharge} = 1.5kΩ.

Maximum Operating Ratings

Parameter	Rating
Junction Temperature (T _J)	-40°C to +125°C

Electrical Characteristics

T_A = 25°C unless otherwise specified.

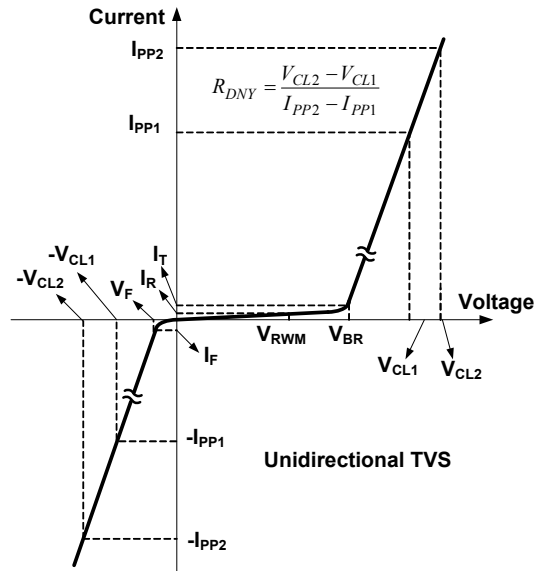

Symbol	Parameter	Condition	Min.	Typ.	Max.	Units
V _{RWM}	Reverse Working Voltage				4.8	V
V _{BR}	Reverse Breakdown Voltage	I _T = 1mA	6	7	8.5	V
I _R	Reverse Leakage Current	V _T = Max. V _{RWM}		0.1	0.5	μA
V _F	Forward Voltage	I _F = 15mA		0.85		V
V _{CL}	Clamping Voltage ⁽³⁾ IEC61000-4-5 Surge 8/20μs	I _{PP} = 1A		7.5	8.5	V
		I _{PP} = 100A		12	13.5	V
		I _{PP} = 160A		14	15.5	V
R _{DNY}	Dynamic Resistance ⁽³⁾	I _{PP} = 1A to 160A		0.04		Ω
C _J	Junction Capacitance	V _{I/O} = 0V, f = 1MHz,		1200		pF

Note:

3. These specifications are guaranteed by design and characterization.

Typical Characteristics

Positive Transmission Line Pulse
($t_p=100\text{ns}$, $t_r=0.2\text{ns}$)

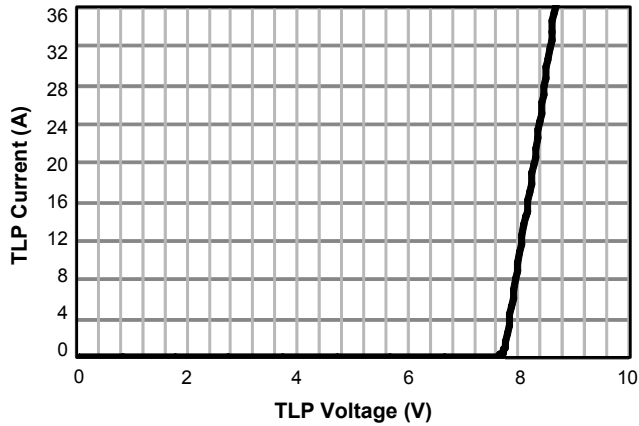

Negative Transmission Line Pulse
($t_p=100\text{ns}$, $t_r=0.2\text{ns}$)

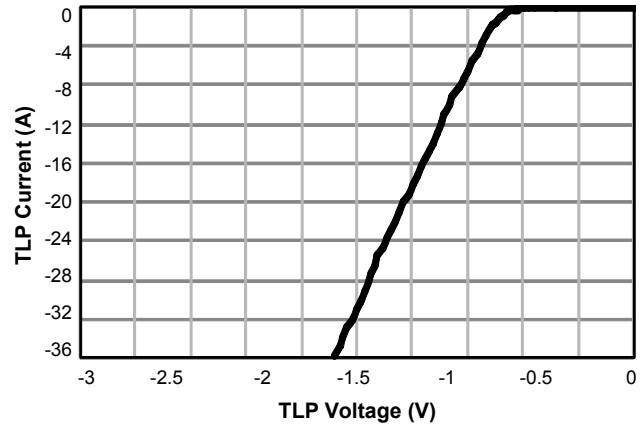

Positive IEC61000-4-5 Surge 8/20 μs

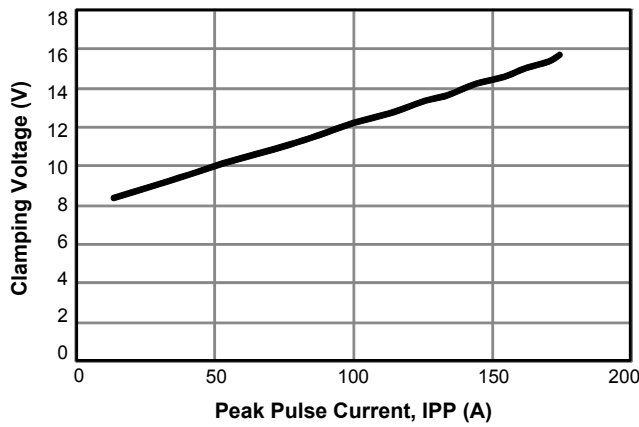

Negative IEC61000-4-5 Surge 8/20 μs

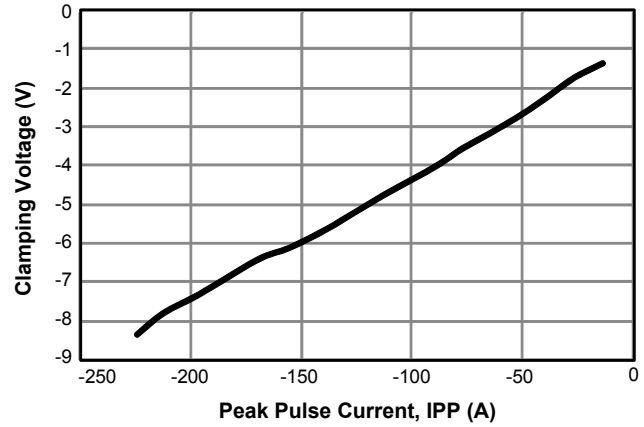

Typical Variations of CJ vs. Input Voltage

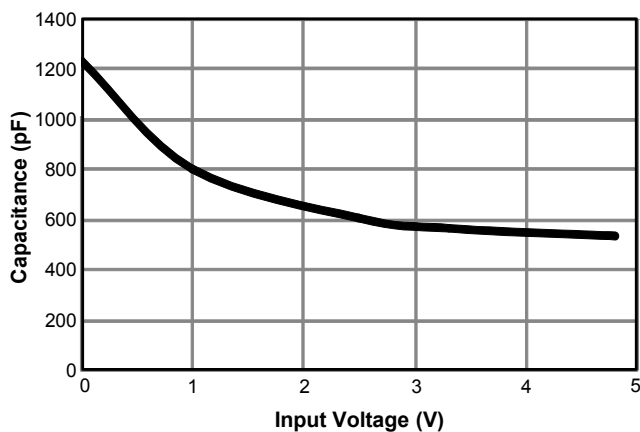

Package Dimensions, DFN2.0x1.25A-2L, EP2_S

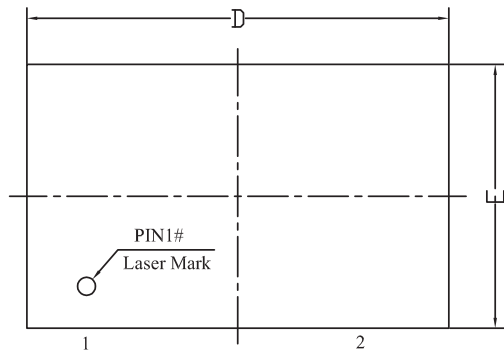

Top View

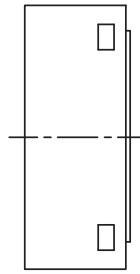

Side View

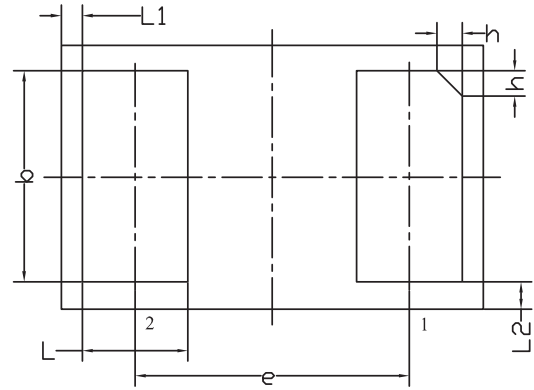

Bottom View

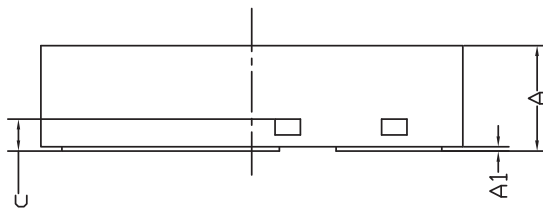

Side View

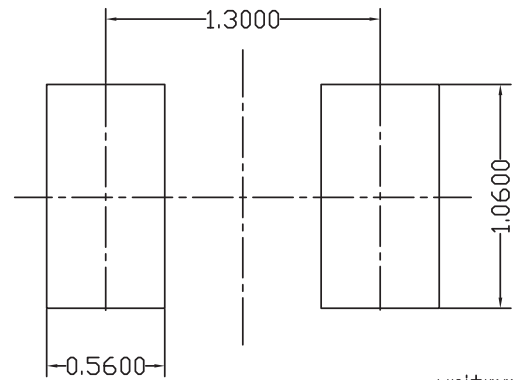

unit:mm

RECOMMEND LAND PATTERN

SYMBOLS	DIMENSIONS IN MILLIMETERS			DIMENSIONS IN INCHES		
	MIN	NOM	MAX	MIN	NOM	MAX
A	0.450	0.500	0.550	0.0177	0.0197	0.0217
A1	0.000	0.020	0.050	0.0000	0.0008	0.0020
b	0.950	1.000	1.050	0.0374	0.0394	0.0413
c	0.152REF			0.0060REF		
D	1.900	2.000	2.100	0.0748	0.0787	0.0827
e	1.300BSC			0.0512BSC		
E	1.200	1.250	1.300	0.0472	0.0492	0.0512
L	0.450	0.500	0.550	0.0177	0.0197	0.0217
L1	0.100REF			0.0039REF		
L2	0.130REF			0.0051REF		
h	0.120REF			0.0047REF		

NOTE

1. ALL DIMENSIONS ARE IN MILLIMETERS.
2. DIMENSIONS ARE INCLUSIVE OF PLATING.
3. PACKAGE BODY SIZES EXCLUDE MOLD FLASH AND GATE BURRS.
MOLD FLASH AT THE NON-LEAD SIDES SHOULD BE LESS THAN 6MIL EACH.
4. CONTROLLING DIMENSION IS MILLIMETER. CONVERTED INCH DIMENSIONS ARE NOT NECESSARILY EXACT.
5. PADDLE EXPOSED ON BOTTOM.

Tape and Reel Dimensions, DFN2.0x1.25A-2L, EP2_S

Carrier Tape

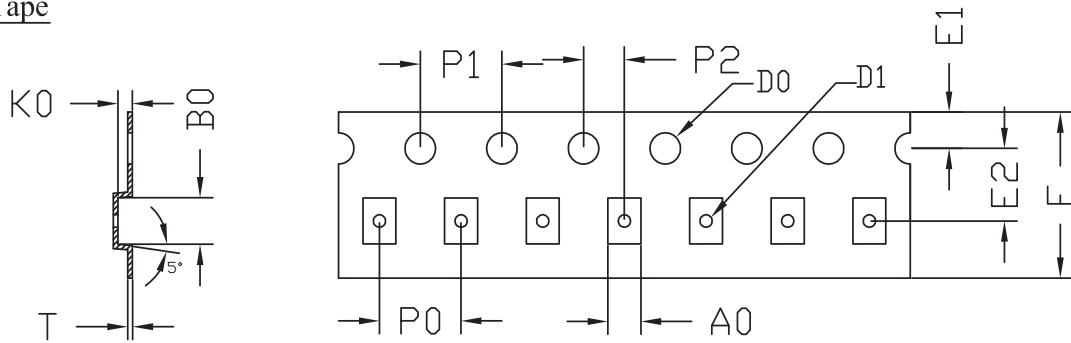

UNIT: MM

PACKAGE	A0	B0	K0	D0	D1	E	E1	E2	P0	P1	P2	T
DFN2.0x1.25	1.61 ±0.05	2.21 ±0.05	0.70 ±0.05	∅1.50 +0.10 -0.00	∅0.60 ±0.05	8.00 +0.3 -0.1	1.75 ±0.1	3.50 ±0.05	4.00 ±0.1	4.0 ±0.10	2.0 ±0.05	0.23 ±0.02

REEL

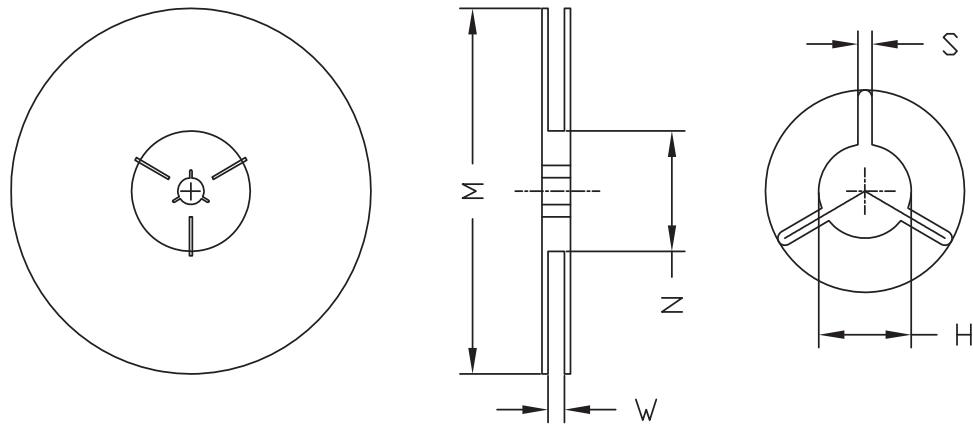

UNIT: MM

TAPE SIZE	REEL SIZE	M	N	W	H	S
8	∅180	∅180.0 ±1.0	∅54.4 ±1.0	8.60 +1.00 -0.00	∅13.0 +0.5 -0.2	2.00 +0.5 -0.0

TAPE

Leader / Trailer
& Orientation

Unit Per Reel:
3000pcs

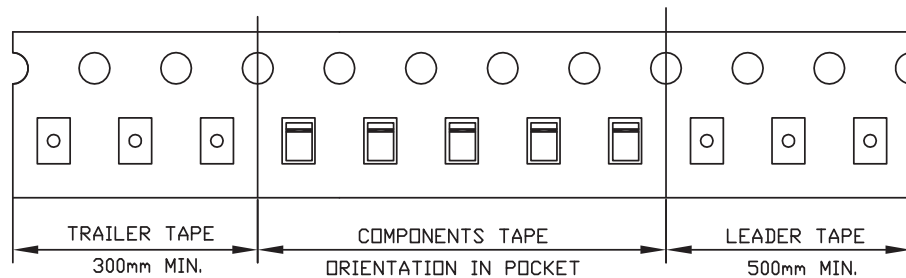

Part Marking

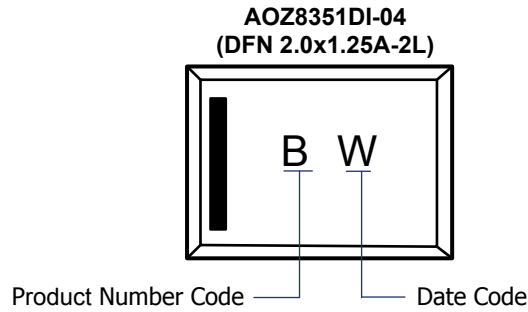

LEGAL DISCLAIMER

Applications or uses as critical components in life support devices or systems are not authorized. AOS does not assume any liability arising out of such applications or uses of its products. AOS reserves the right to make changes to product specifications without notice. It is the responsibility of the customer to evaluate suitability of the product for their intended application. Customer shall comply with applicable legal requirements, including all applicable export control rules, regulations and limitations.

AOS' products are provided subject to AOS' terms and conditions of sale which are set forth at:

http://www.aosmd.com/terms_and_conditions_of_sale

LIFE SUPPORT POLICY

ALPHA AND OMEGA SEMICONDUCTOR PRODUCTS ARE NOT AUTHORIZED FOR USE AS CRITICAL COMPONENTS IN LIFE SUPPORT DEVICES OR SYSTEMS.

As used herein:

- | | |
|---|---|
| <p>1. Life support devices or systems are devices or systems which, (a) are intended for surgical implant into the body or (b) support or sustain life, and (c) whose failure to perform when properly used in accordance with instructions for use provided in the labeling, can be reasonably expected to result in a significant injury of the user.</p> | <p>2. A critical component in any component of a life support, device, or system whose failure to perform can be reasonably expected to cause the failure of the life support device or system, or to affect its safety or effectiveness.</p> |
|---|---|