

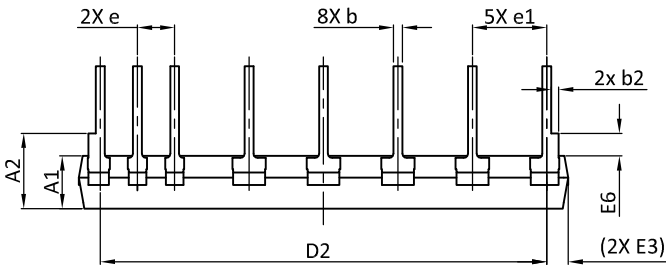

IPM-5 Package Outline

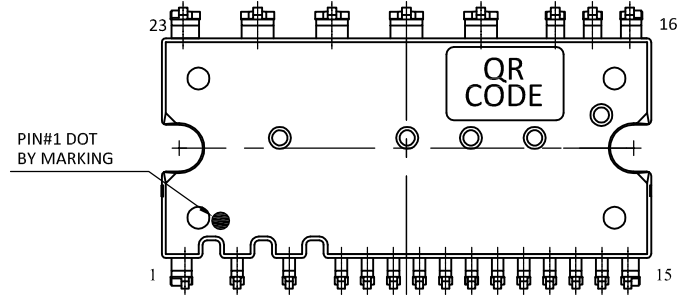

SIDE VIEW



BOTTOM VIEW

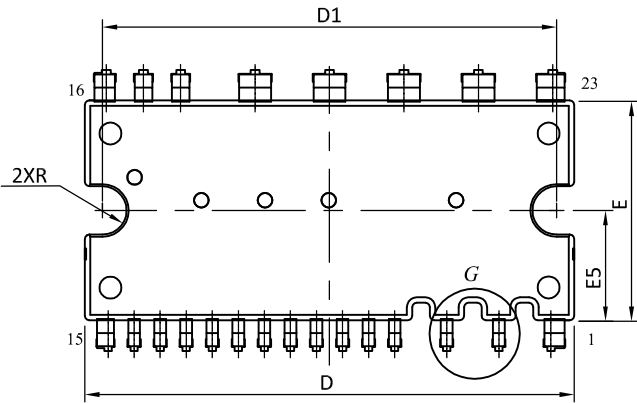

TOP VIEW

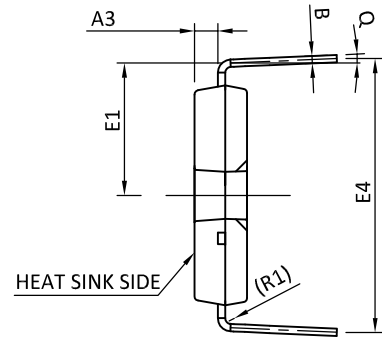
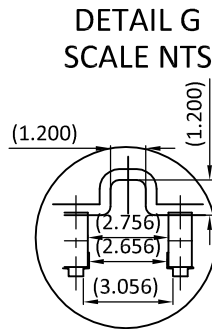

SIDE VIEW

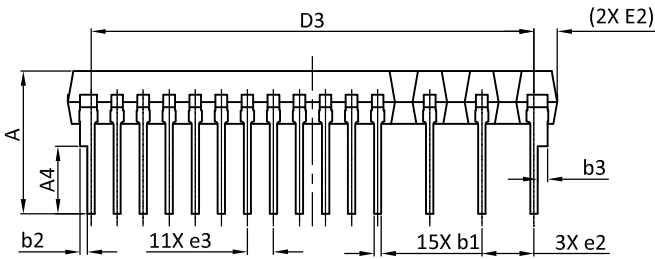

SIDE VIEW

LAND PATTERN RECOMMENDATIONS

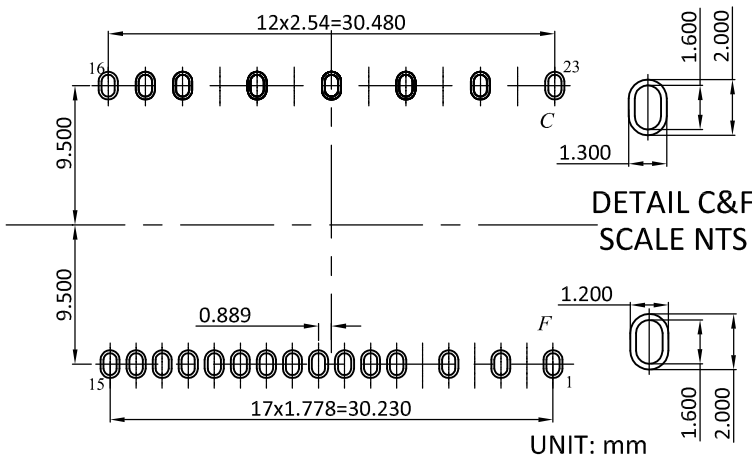

DETAIL C&F
SCALE NTS

SYMBOLS	DIMENSION IN MILLIMETRES			DIMENSION IN INCHS		
	MIN.	NOM.	MAX.	MIN.	NOM.	MAX.
A	9.300	9.700	10.100	0.366	0.382	0.398
A1	3.300	3.600	3.900	0.130	0.142	0.154
A2	4.700	5.100	5.500	0.185	0.201	0.217
A3	1.500	1.600	1.700	0.059	0.063	0.067
A4	4.200	4.600	5.000	0.165	0.181	0.197
B	0.400	0.500	0.600	0.016	0.020	0.024
b	0.500	0.600	0.700	0.020	0.024	0.028
b1	0.400	0.500	0.600	0.016	0.020	0.024
b2	0.400	0.500	0.600	0.016	0.020	0.024
b3	0.600	0.700	0.800	0.024	0.028	0.031
D	33.100	33.400	33.700	1.303	1.315	1.327
D1	30.800	31.000	31.200	1.213	1.220	1.228
D2	30.180	30.480	30.780	1.188	1.200	1.212
D3	29.930	30.230	30.530	1.178	1.190	1.202
E	14.700	15.000	15.300	0.579	0.591	0.602
E1	8.600	9.000	9.400	0.339	0.354	0.370
E2	1.600REF			0.063REF		
E3	1.500REF			0.059REF		
E4	18.300	18.700	19.100	0.720	0.736	0.752
E5	7.300	7.500	7.700	0.287	0.295	0.303
E6	1.100	1.500	1.900	0.043	0.059	0.075
e	2.340	2.540	2.740	0.092	0.100	0.108
e1	4.880	5.080	5.280	0.192	0.200	0.208
e2	3.356	3.556	3.756	0.132	0.140	0.148
e3	1.578	1.778	1.978	0.062	0.070	0.078
R	1.500	1.600	1.700	0.059	0.063	0.067
R1	0.400REF			0.016REF		
Q	2° - 6°			2° - 6°		

NOTES

1. PACKAGE BODY SIZES EXCLUDE MOLD FLASH AND GATE BURRS, MOLD FLASH SHOULD BE LESS THAN 6 MIL.
2. TOLERANCE 0.100 MILLIMETERS UNLESS OTHERWISE SPECIFIED.
3. CONTROLLING DIMENSION IS MILLIMETER, CONVERTED INCH DIMENSIONS ARE NOT NECESSARILY EXACT.
4. () IS REFERENCE.