

General Description

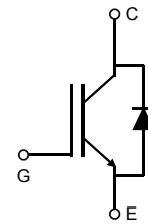
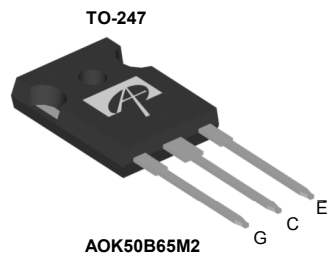
- Latest AlphaIGBT (α IGBT) technology
- 650V breakdown voltage
- Very fast and soft recovery freewheeling diode
- High efficient turn-on di/dt controllability
- Low VCE(SAT) enables high efficiencies
- Low turn-off switching loss and softness
- Very good EMI behavior
- High short-circuit ruggedness

Applications

- Motor Drives
- Servo and General Purpose Inverters
- Other Hard Switching Applications

Product Summary

V_{CE}	650V
I_C ($T_C=100^\circ\text{C}$)	50A
$V_{CE(sat)}$ ($T_J=25^\circ\text{C}$)	1.72V



Orderable Part Number	Package Type	Form	Minimum Order Quantity
AOK50B65M2	TO247	Tube	240

Absolute Maximum Ratings $T_A=25^\circ\text{C}$ unless otherwise noted

Parameter	Symbol	AOK50B65M2	Units
Collector-Emitter Voltage	V_{CE}	650	V
Gate-Emitter Voltage	V_{GE}	± 30	V
Continuous Collector Current	I_C	$T_C=25^\circ\text{C}$	100
		$T_C=100^\circ\text{C}$	50
Pulsed Collector Current, Limited by T_{Jmax}	I_{CM}	150	A
Turn off SOA, $V_{CE} \leq 650\text{V}$, Limited by T_{Jmax}	I_{LM}	150	A
Continuous Diode Forward Current	I_F	$T_C=25^\circ\text{C}$	100
		$T_C=100^\circ\text{C}$	50
Diode Pulsed Current, Limited by T_{Jmax}	I_{FM}	150	A
Short circuit withstanding time ¹⁾ $V_{GE}=15\text{V}$, $V_{CC} \leq 400\text{V}$, $T_J \leq 175^\circ\text{C}$	t_{SC}	5	μs
Power Dissipation	P_D	$T_C=25^\circ\text{C}$	500
		$T_C=100^\circ\text{C}$	250
Junction and Storage Temperature Range	T_J, T_{STG}	-55 to 175	$^\circ\text{C}$
Maximum lead temperature for soldering purpose, 1/8" from case for 5 seconds	T_L	300	$^\circ\text{C}$

Thermal Characteristics

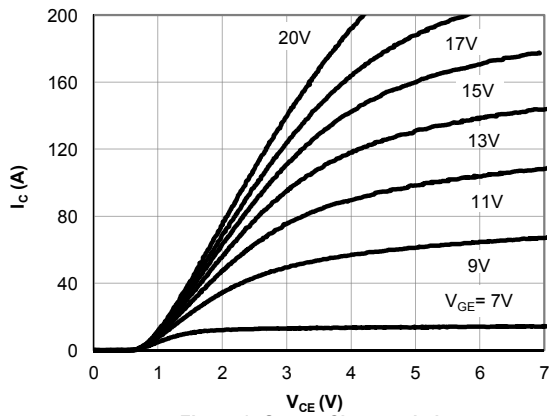
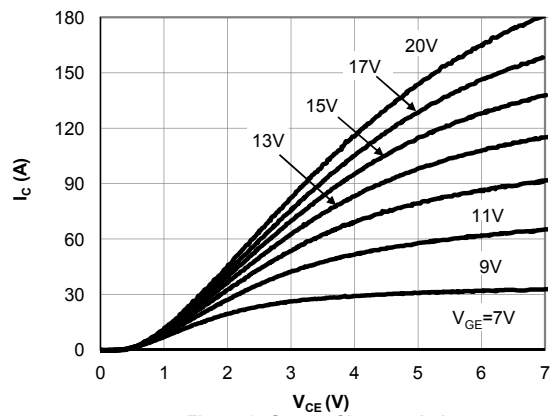
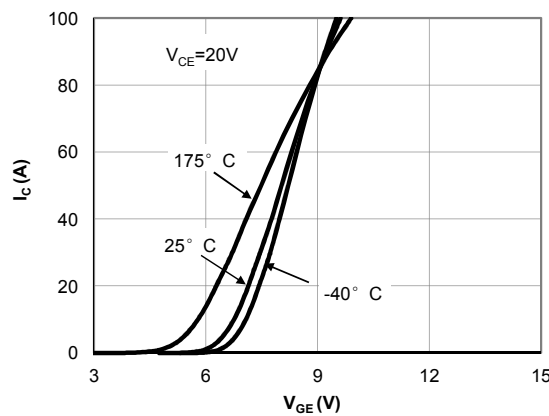
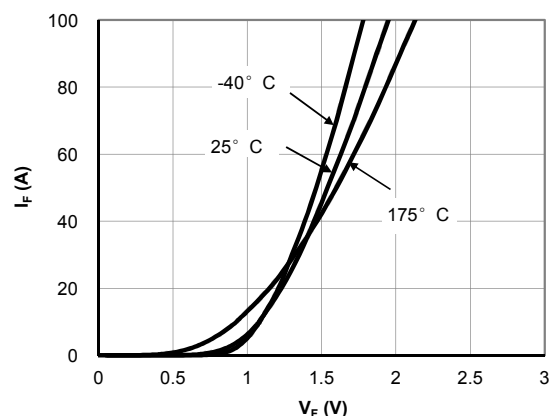
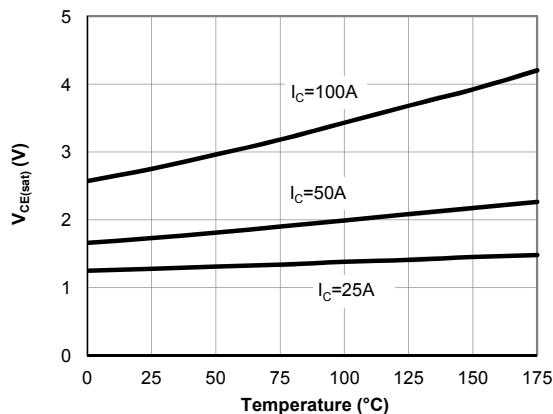
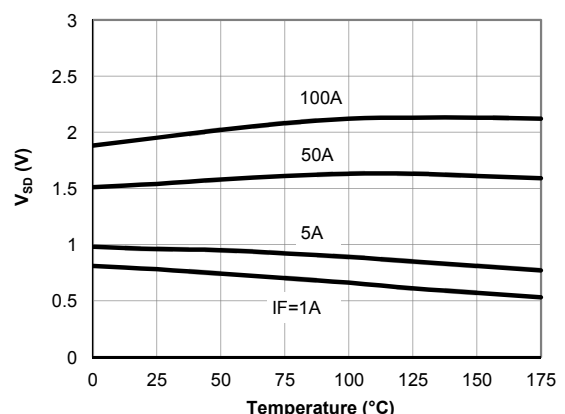
Parameter	Symbol	AOK50B65M2	Units
Maximum Junction-to-Ambient	$R_{\theta JA}$	40	$^\circ\text{C}/\text{W}$
Maximum IGBT Junction-to-Case	$R_{\theta JC}$	0.3	$^\circ\text{C}/\text{W}$
Maximum Diode Junction-to-Case	$R_{\theta JC}$	0.7	$^\circ\text{C}/\text{W}$

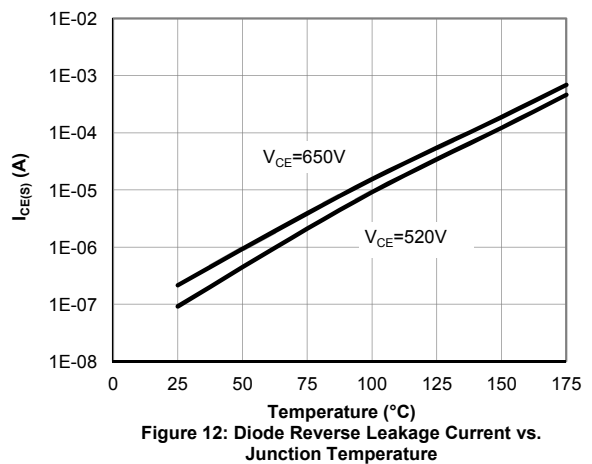
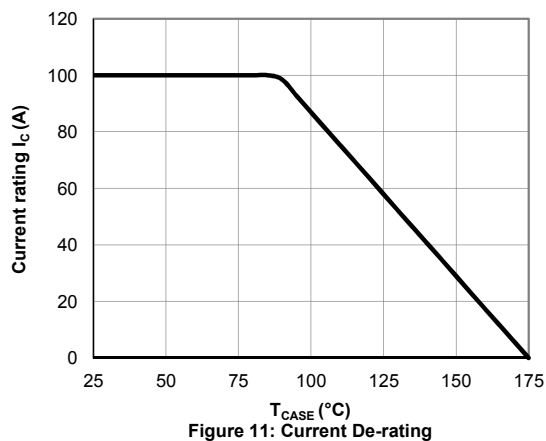
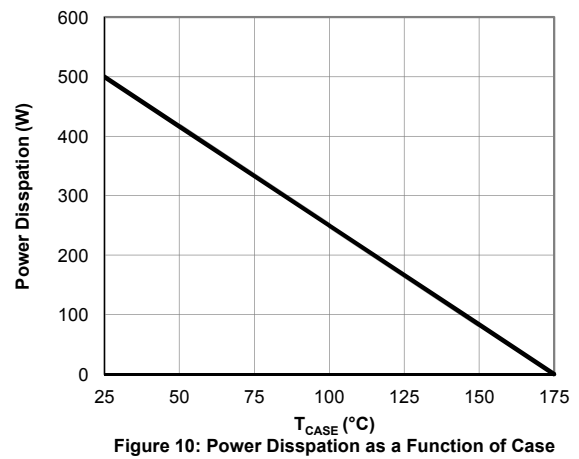
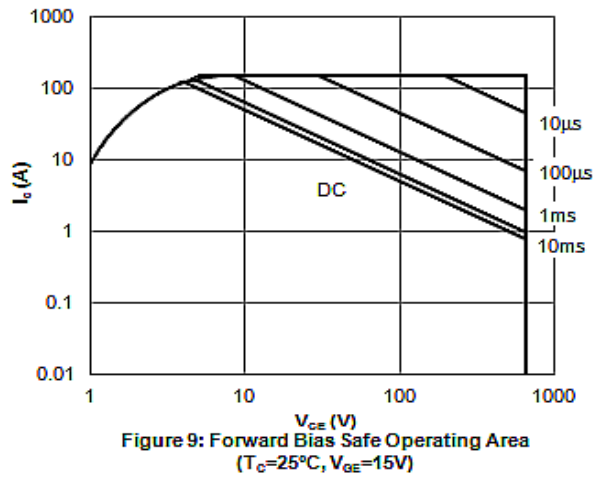
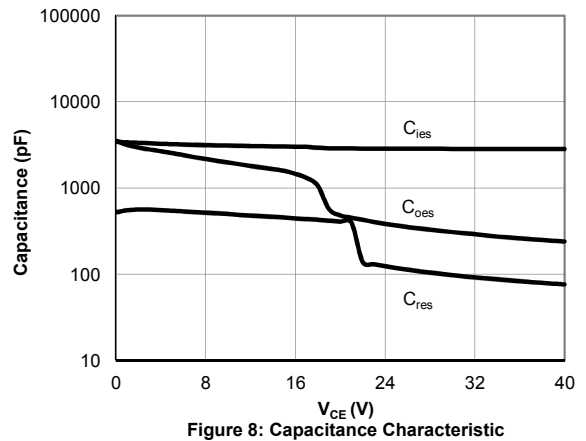
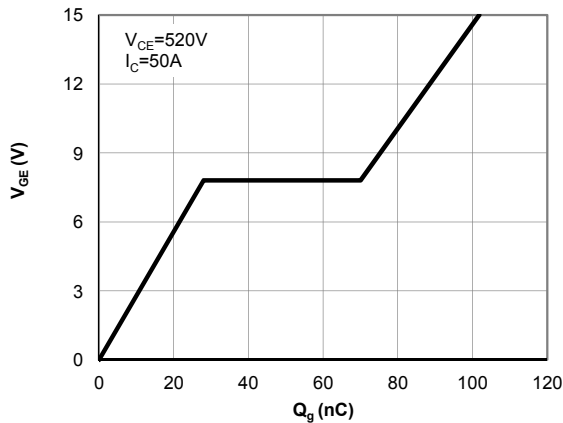
1) Allowed number of short circuits: <1000; time between short circuits: >1s.

Electrical Characteristics (T_J=25°C unless otherwise noted)

Symbol	Parameter	Conditions	Min	Typ	Max	Units	
STATIC PARAMETERS							
BV_{CES}	Collector-Emitter Breakdown Voltage	$I_C=1mA, V_{GE}=0V, T_J=25^\circ C$	650	-	-	V	
$V_{CE(sat)}$	Collector-Emitter Saturation Voltage	$V_{GE}=15V, I_C=50A$	$T_J=25^\circ C$	-	1.72	2.2	V
			$T_J=125^\circ C$	-	2.08	-	
			$T_J=175^\circ C$	-	2.26	-	
V_F	Diode Forward Voltage	$V_{GE}=0V, I_C=50A$	$T_J=25^\circ C$	-	1.55	1.95	V
			$T_J=125^\circ C$	-	1.63	-	
			$T_J=175^\circ C$	-	1.59	-	
$V_{GE(th)}$	Gate-Emitter Threshold Voltage	$V_{CE}=5V, I_C=1mA$	-	4.8	-	V	
I_{CES}	Zero Gate Voltage Collector Current	$V_{CE}=650V, V_{GE}=0V$	$T_J=25^\circ C$	-	-	10	μA
			$T_J=125^\circ C$	-	-	1000	
			$T_J=175^\circ C$	-	-	15000	
I_{GES}	Gate-Emitter leakage current	$V_{CE}=0V, V_{GE}=\pm 30V$	-	-	± 100	nA	
g_{FS}	Forward Transconductance	$V_{CE}=20V, I_C=50A$	-	35	-	S	
DYNAMIC PARAMETERS							
C_{ies}	Input Capacitance	$V_{GE}=0V, V_{CC}=25V, f=1MHz$	-	2848	-	pF	
C_{oes}	Output Capacitance		-	368	-	pF	
C_{res}	Reverse Transfer Capacitance		-	118	-	pF	
Q_g	Total Gate Charge	$V_{GE}=15V, V_{CC}=520V, I_C=50A$	-	102	-	nC	
Q_{ge}	Gate to Emitter Charge		-	28	-	nC	
Q_{gc}	Gate to Collector Charge		-	42	-	nC	
$I_{C(SC)}$	Short circuit collector current	$V_{GE}=15V, V_{CC}=400V,$ $t_{sc} \leq 5\mu s, T_J \leq 175^\circ C$	-	222	-	A	
R_g	Gate resistance	$V_{GE}=0V, V_{CC}=0V, f=1MHz$	-	14	-	Ω	
SWITCHING PARAMETERS, (Load Inductive, T_J=25°C)							
$t_{D(on)}$	Turn-On Delay Time	$T_J=25^\circ C$ $V_{GE}=15V, V_{CC}=400V, I_C=50A,$ $R_G=6\Omega$	-	46	-	ns	
t_r	Turn-On Rise Time		-	68	-	ns	
$t_{D(off)}$	Turn-Off Delay Time		-	182	-	ns	
t_f	Turn-Off Fall Time		-	49	-	ns	
E_{on}	Turn-On Energy		-	2.09	-	mJ	
E_{off}	Turn-Off Energy		-	1.03	-	mJ	
E_{total}	Total Switching Energy		-	3.12	-	mJ	
t_{rr}	Diode Reverse Recovery Time		$T_J=25^\circ C$	-	327	-	ns
Q_{rr}	Diode Reverse Recovery Charge		$I_F=50A, di/dt=200A/\mu s, V_{CC}=400V$	-	1.3	-	μC
I_{rm}	Diode Peak Reverse Recovery Current			-	8	-	A
SWITCHING PARAMETERS, (Load Inductive, T_J=175°C)							
$t_{D(on)}$	Turn-On Delay Time	$T_J=175^\circ C$ $V_{GE}=15V, V_{CC}=400V, I_C=50A,$ $R_G=6\Omega$	-	44	-	ns	
t_r	Turn-On Rise Time		-	70	-	ns	
$t_{D(off)}$	Turn-Off Delay Time		-	224	-	ns	
t_f	Turn-Off Fall Time		-	44	-	ns	
E_{on}	Turn-On Energy		-	2.54	-	mJ	
E_{off}	Turn-Off Energy		-	1.56	-	mJ	
E_{total}	Total Switching Energy		-	4.1	-	mJ	
t_{rr}	Diode Reverse Recovery Time		$T_J=175^\circ C$	-	508	-	ns
Q_{rr}	Diode Reverse Recovery Charge		$I_F=50A, di/dt=200A/\mu s, V_{CC}=400V$	-	3.4	-	μC
I_{rm}	Diode Peak Reverse Recovery Current			-	12	-	A

THIS PRODUCT HAS BEEN DESIGNED AND QUALIFIED FOR THE CONSUMER MARKET. APPLICATIONS OR USES AS CRITICAL COMPONENTS IN LIFE SUPPORT DEVICES OR SYSTEMS ARE NOT AUTHORIZED. AOS DOES NOT ASSUME ANY LIABILITY ARISING OUT OF SUCH APPLICATIONS OR USES OF ITS PRODUCTS. AOS RESERVES THE RIGHT TO IMPROVE PRODUCT DESIGN, FUNCTIONS AND RELIABILITY WITHOUT NOTICE.

TYPICAL ELECTRICAL AND THERMAL CHARACTERISTICS

Figure 1: Output Characteristic
 $(T_j=25^\circ\text{C})$

Figure 2: Output Characteristic
 $(T_j=175^\circ\text{C})$

Figure 3: Transfer Characteristic

Figure 4: Diode Characteristic

Figure 5: Collector-Emitter Saturation Voltage vs. Junction Temperature

Figure 6: Diode Forward voltage vs. Junction Temperature

TYPICAL ELECTRICAL AND THERMAL CHARACTERISTICS


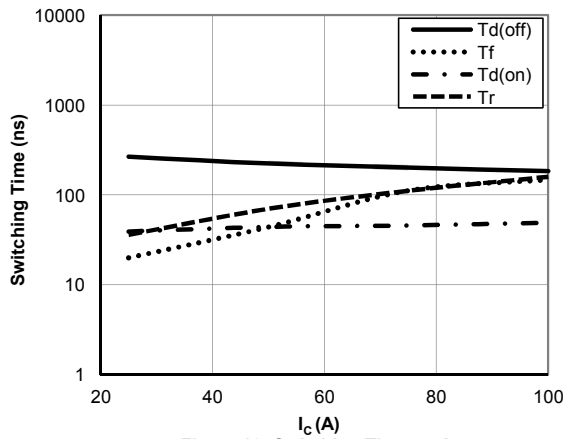
TYPICAL ELECTRICAL AND THERMAL CHARACTERISTICS


Figure 13: Switching Time vs. I_C
 ($T_J=175^\circ\text{C}$, $V_{GE}=15\text{V}$, $V_{CE}=400\text{V}$, $R_g=6\Omega$)

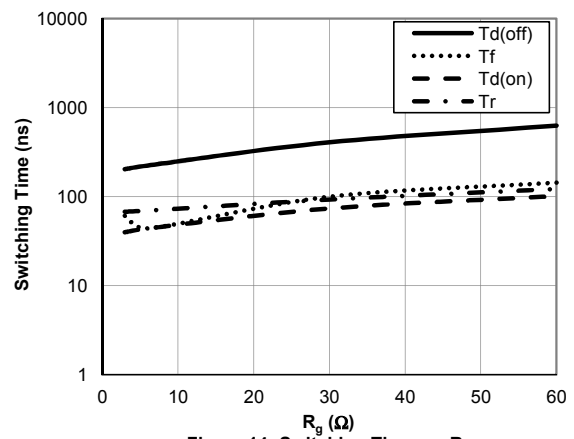


Figure 14: Switching Time vs. R_g
 ($T_J=175^\circ\text{C}$, $V_{GE}=15\text{V}$, $V_{CE}=400\text{V}$, $I_C=50\text{A}$)

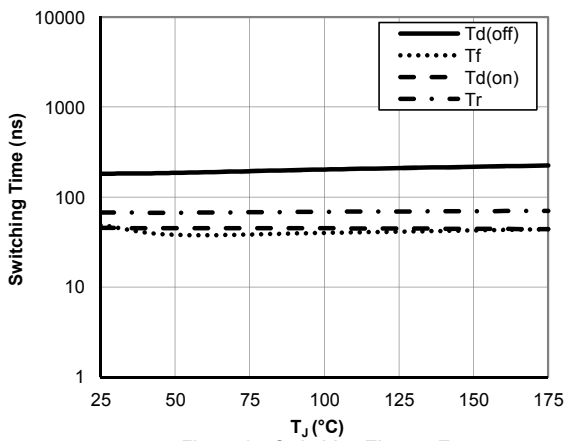


Figure 15: Switching Time vs. T_J
 ($V_{GE}=15\text{V}$, $V_{CE}=400\text{V}$, $I_C=50\text{A}$, $R_g=6\Omega$)

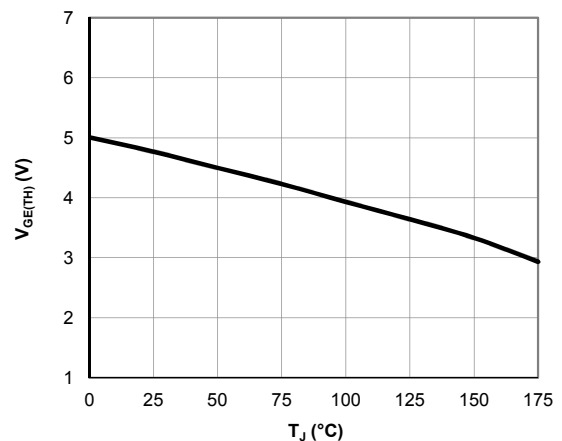


Figure 16: $V_{GE(\text{TH})}$ vs. T_J

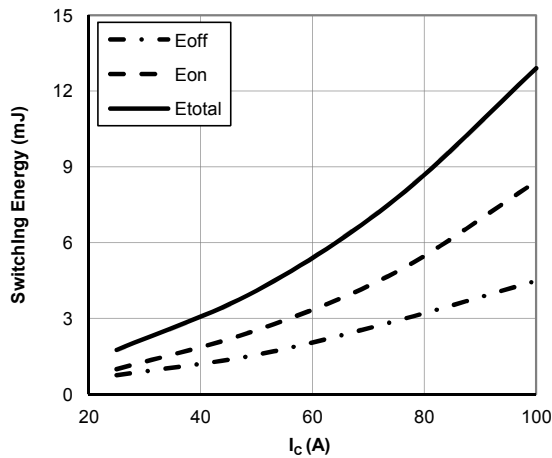
TYPICAL ELECTRICAL AND THERMAL CHARACTERISTICS


Figure 17: Switching Loss vs. I_C
 ($T_J=175^\circ\text{C}$, $V_{GE}=15\text{V}$, $V_{CE}=400\text{V}$, $R_g=6\Omega$)

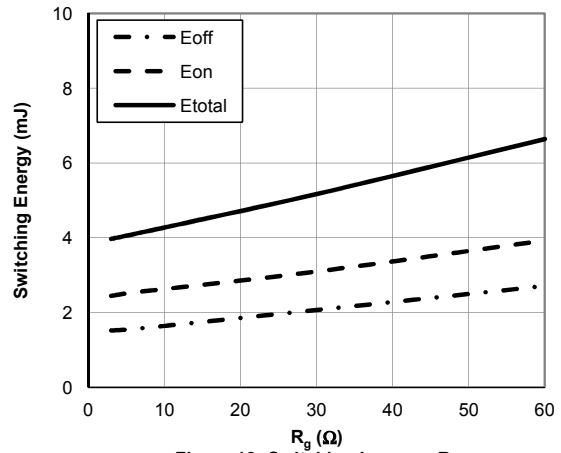


Figure 18: Switching Loss vs. R_g
 ($T_J=175^\circ\text{C}$, $V_{GE}=15\text{V}$, $V_{CE}=400\text{V}$, $I_C=50\text{A}$)

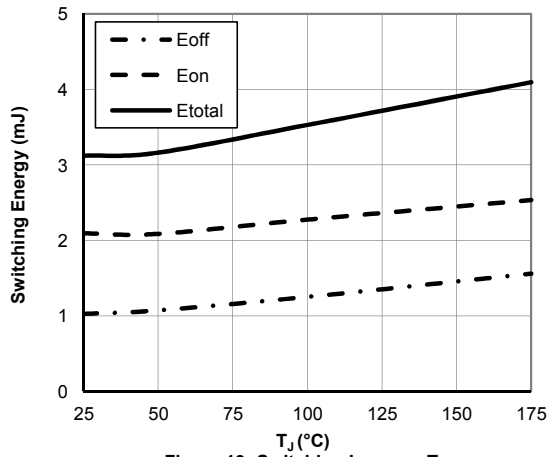


Figure 19: Switching Loss vs. T_J
 ($V_{GE}=15\text{V}$, $V_{CE}=400\text{V}$, $I_C=50\text{A}$, $R_g=6\Omega$)

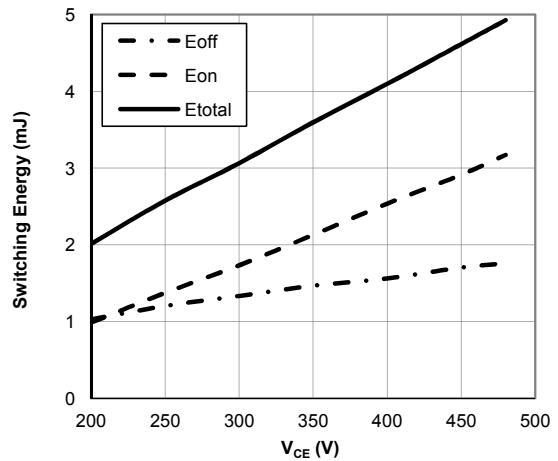


Figure 20: Switching Loss vs. V_{CE}
 ($T_J=175^\circ\text{C}$, $V_{GE}=15\text{V}$, $I_C=50\text{A}$, $R_g=6\Omega$)

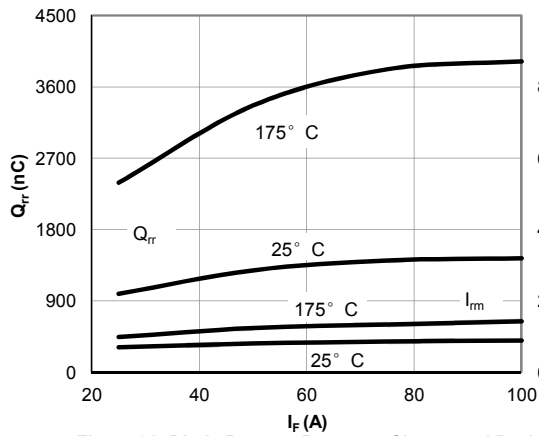
TYPICAL ELECTRICAL AND THERMAL CHARACTERISTICS


Figure 21: Diode Reverse Recovery Charge and Peak Current vs. Conduction Current
 ($V_{GE}=15V$, $V_{CE}=400V$, $di/dt=200A/\mu s$)

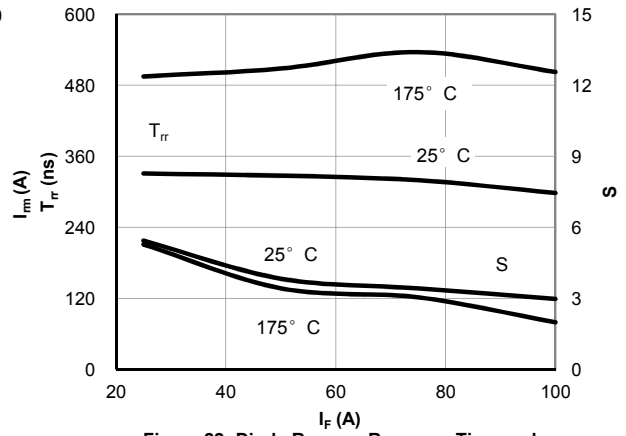


Figure 22: Diode Reverse Recovery Time and Softness Factor vs. Conduction Current
 ($V_{GE}=15V$, $V_{CE}=400V$, $di/dt=200A/\mu s$)

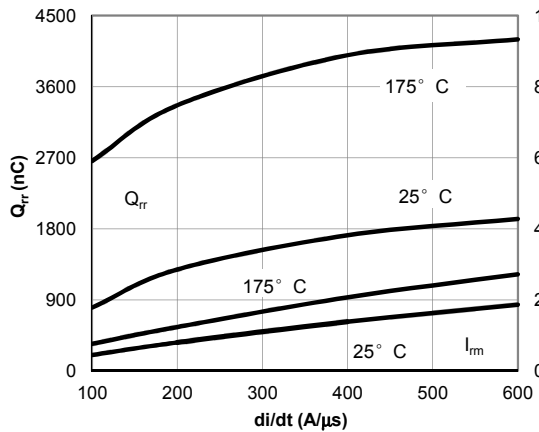


Figure 23: Diode Reverse Recovery Charge and Peak Current vs. di/dt
 ($V_{GE}=15V$, $V_{CE}=400V$, $I_F=50A$)

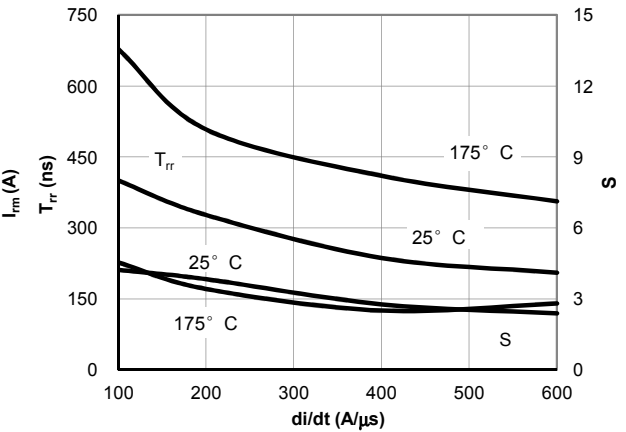
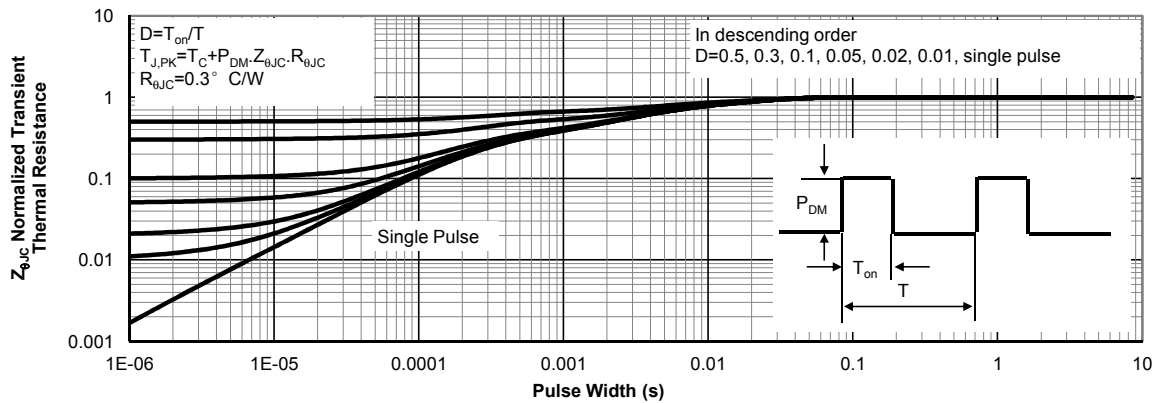
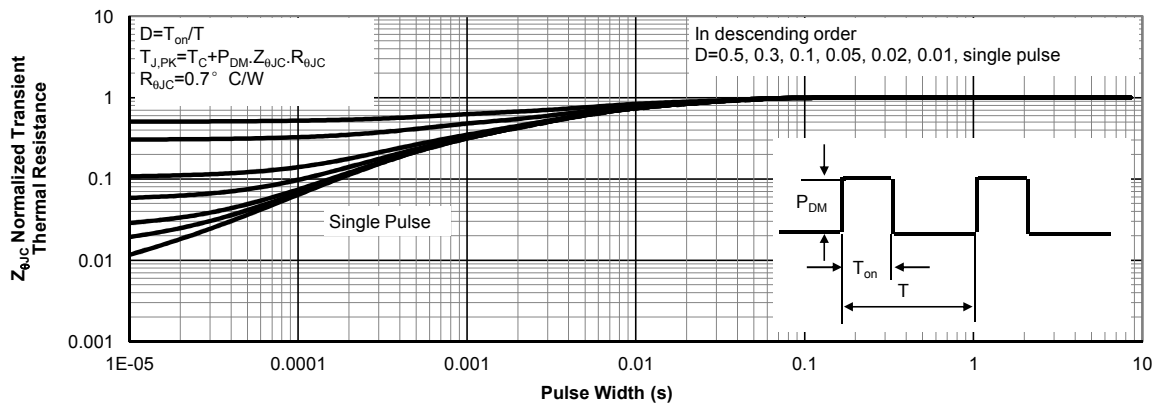


Figure 24: Diode Reverse Recovery Time and Softness Factor vs. di/dt
 ($V_{GE}=15V$, $V_{CE}=400V$, $I_F=50A$)

TYPICAL ELECTRICAL AND THERMAL CHARACTERISTICS

Figure 25: Normalized Maximum Transient Thermal Impedance for IGBT

Figure 26: Normalized Maximum Transient Thermal Impedance for Diode

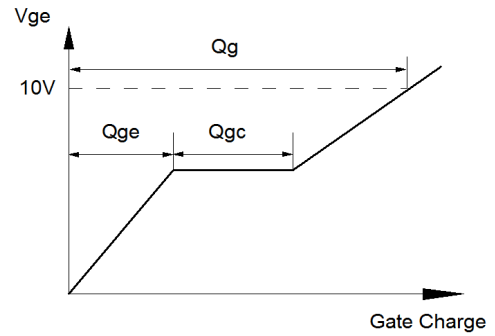
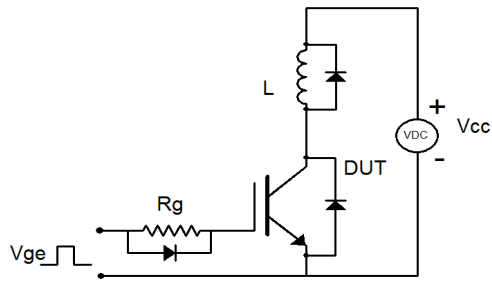


Figure A: Gate Charge Test Circuit & Waveforms

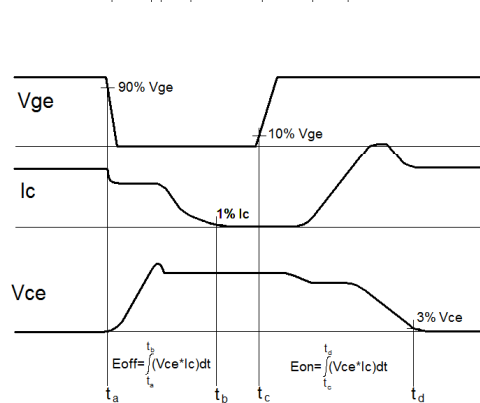
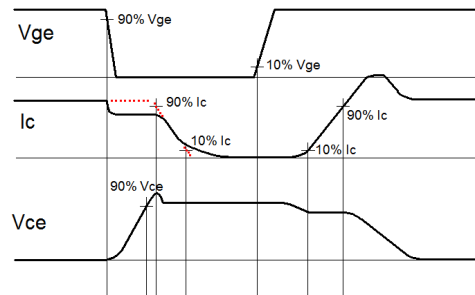
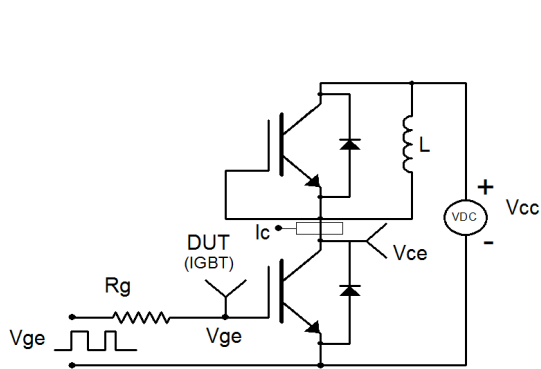


Figure B: Inductive Switching Test Circuit & Waveforms

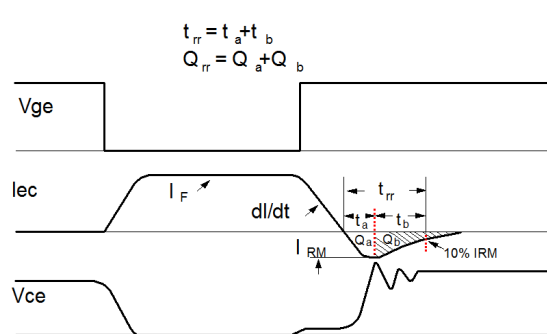
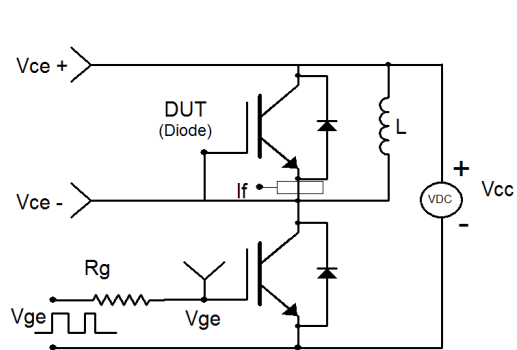


Figure C: Diode Recovery Test Circuit & Waveforms