

General Description

- Latest Trench Power AlphaMOS (αMOS LV) technology
- Very Low RDS(on) at 4.5V_{GS}
- Low Gate Charge
- High Current Capability
- RoHS and Halogen-Free Compliant

Application

- DC/DC Converters in Computing, Servers, and POL
- Isolated DC/DC Converters in Telecom and Industrial

Product Summary

| | Q1 | Q2 |
|---|---------|---------|
| V _{DS} | 30V | 30V |
| I _D (at V _{GS} =10V) | 16A | 18A |
| R _{DS(ON)} (at V _{GS} =10V) | <10.2mΩ | <7.7mΩ |
| R _{DS(ON)} (at V _{GS} = 4.5V) | <15.8mΩ | <11.6mΩ |

100% UIS Tested

100% R_g Tested

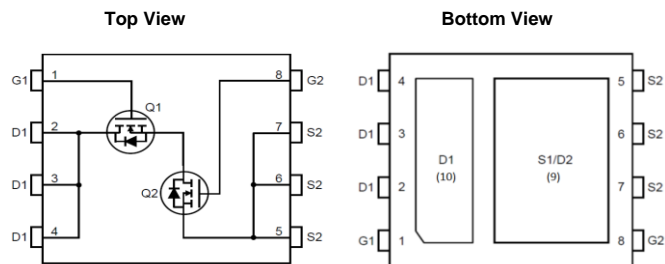
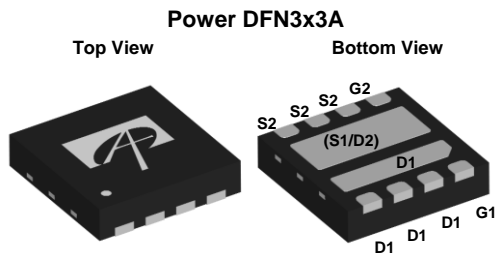

Absolute Maximum Ratings T_A=25°C unless otherwise noted

| Parameter | Symbol | Max Q1 | Max Q2 | Units | |
|--|-----------------------------------|-----------------------|--------|-------|----|
| Drain-Source Voltage | V _{DS} | 30 | | V | |
| Gate-Source Voltage | V _{GS} | ±20 | ±20 | V | |
| Continuous Drain Current ^G | T _C =25°C | 16 | 18 | A | |
| | | T _C =100°C | 12 | | 14 |
| Pulsed Drain Current ^C | I _{DM} | 64 | 72 | A | |
| Continuous Drain Current | T _A =25°C | 13 | 15 | A | |
| | T _A =70°C | 7.8 | 9 | | |
| Avalanche Current ^C | I _{AS} | 19 | 25 | A | |
| Avalanche Energy L=0.05mH ^C | E _{AS} | 9 | 16 | mJ | |
| V _{DS} Spike | 100ns | V _{SPIKE} | 36 | 36 | V |
| Power Dissipation ^B | T _C =25°C | P _D | 23 | 25 | W |
| | T _C =100°C | | 9 | 10 | |
| Power Dissipation ^A | T _A =25°C | P _{DSM} | 2.5 | 2.5 | W |
| | T _A =70°C | | 0.9 | 0.9 | |
| Junction and Storage Temperature Range | T _J , T _{STG} | -55 to 150 | | °C | |

Thermal Characteristics

| Parameter | Symbol | Typ Q1 | Max Q1 | Typ Q2 | Max Q2 | Units |
|--|------------------|--------------|--------|--------|--------|-------|
| Maximum Junction-to-Ambient ^A | R _{θJA} | 40 | 50 | 40 | 50 | °C/W |
| Maximum Junction-to-Ambient ^{A,D} | | Steady-State | 70 | 90 | 70 | |
| Maximum Junction-to-Case | R _{θJC} | 4.5 | 5.4 | 4.2 | 5 | °C/W |

Q1 Electrical Characteristics (T_J=25°C unless otherwise noted)

| Symbol | Parameter | Conditions | Min | Typ | Max | Units |
|-----------------------------|--|---|-----|------|--------|-------|
| STATIC PARAMETERS | | | | | | |
| BV _{DSS} | Drain-Source Breakdown Voltage | I _D =250μA, V _{GS} =0V | 30 | | | V |
| I _{DSS} | Zero Gate Voltage Drain Current | V _{DS} =30V, V _{GS} =0V T _J =55°C | | | 1 5 | μA |
| I _{GSS} | Gate-Body leakage current | V _{DS} =0V, V _{GS} = ±20V | | | 100 | nA |
| V _{GS(th)} | Gate Threshold Voltage | V _{DS} =V _{GS} I _D =250μA | 1.2 | 1.8 | 2.2 | V |
| R _{DS(ON)} | Static Drain-Source On-Resistance | V _{GS} =10V, I _D =13A T _J =125°C | | 8.3 | 10.2 | mΩ |
| | | V _{GS} =4.5V, I _D =10A | | 11.2 | 13.7 | mΩ |
| g _{FS} | Forward Transconductance | V _{DS} =5V, I _D =13A | | 50 | | S |
| V _{SD} | Diode Forward Voltage | I _S =1A, V _{GS} =0V | | 0.7 | 1 | V |
| I _S | Maximum Body-Diode Continuous Current ^G | | | | 16 | A |
| DYNAMIC PARAMETERS | | | | | | |
| C _{iss} | Input Capacitance | V _{GS} =0V, V _{DS} =15V, f=1MHz | | 485 | | pF |
| C _{oss} | Output Capacitance | | | 235 | | pF |
| C _{rss} | Reverse Transfer Capacitance | | | 32 | | pF |
| R _g | Gate resistance | V _{GS} =0V, V _{DS} =0V, f=1MHz | 0.9 | 1.8 | 2.7 | Ω |
| SWITCHING PARAMETERS | | | | | | |
| Q _g (10V) | Total Gate Charge | V _{GS} =10V, V _{DS} =15V, I _D =13A | | 8 | 11 | nC |
| Q _g (4.5V) | Total Gate Charge | | | 3.9 | 5.3 | nC |
| Q _{gs} | Gate Source Charge | | | 1.1 | | nC |
| Q _{gd} | Gate Drain Charge | | | 2.1 | | nC |
| t _{D(on)} | Turn-On DelayTime | V _{GS} =10V, V _{DS} =15V, R _L =1.2Ω, R _{GEN} =3Ω | | 3.5 | | ns |
| t _r | Turn-On Rise Time | | | 2.8 | | ns |
| t _{D(off)} | Turn-Off DelayTime | | | 16.3 | | ns |
| t _f | Turn-Off Fall Time | | | 3 | | ns |
| t _{rr} | Body Diode Reverse Recovery Time | I _F =13A, di/dt=500A/μs | | 9.9 | | ns |
| Q _{rr} | Body Diode Reverse Recovery Charge | I _F =13A, di/dt=500A/μs | | 12.9 | | nC |

A. The value of R_{θJA} is measured with the device mounted on 1in² FR-4 board with 2oz. Copper, in a still air environment with T_A =25° C. The Power dissipation P_{DSM} is based on R_{θJA} t_s ≤ 10s value and the maximum allowed junction temperature of 150° C. The value in any given application depends on the user's specific board design.

B. The power dissipation P_D is based on T_{J(MAX)}=150° C, using junction-to-case thermal resistance, and is more useful in setting the upper dissipation limit for cases where additional heatsinking is used.

C. Repetitive rating, pulse width limited by junction temperature T_{J(MAX)}=150° C. Ratings are based on low frequency and duty cycles to keep initial T_J =25° C.

D. The R_{θJA} is the sum of the thermal impedance from junction to case R_{θJC} and case to ambient.

E. The static characteristics in Figures 1 to 6 are obtained using <300μs pulses, duty cycle 0.5% max.

F. These curves are based on the junction-to-case thermal impedance which is measured with the device mounted to a large heatsink, assuming a maximum junction temperature of T_{J(MAX)}=150° C. The SOA curve provides a single pulse rating.

G. The maximum current rating is limited by package.

H. These tests are performed with the device mounted on 1 in² FR-4 board with 2oz. Copper, in a still air environment with TA=25° C.

APPLICATIONS OR USES AS CRITICAL COMPONENTS IN LIFE SUPPORT DEVICES OR SYSTEMS ARE NOT AUTHORIZED. AOS DOES NOT ASSUME ANY LIABILITY ARISING OUT OF SUCH APPLICATIONS OR USES OF ITS PRODUCTS. AOS RESERVES THE RIGHT TO MAKE CHANGES TO PRODUCT SPECIFICATIONS WITHOUT NOTICE. IT IS THE RESPONSIBILITY OF THE CUSTOMER TO EVALUATE SUITABILITY OF THE PRODUCT FOR THEIR INTENDED APPLICATION. CUSTOMER SHALL COMPLY WITH APPLICABLE LEGAL REQUIREMENTS, INCLUDING ALL APPLICABLE EXPORT CONTROL RULES, REGULATIONS AND LIMITATIONS.

AOS' products are provided subject to AOS' terms and conditions of sale which are set forth at:

http://www.aosmd.com/terms_and_conditions_of_sale

Q1-CHANNEL: TYPICAL ELECTRICAL AND THERMAL CHARACTERISTICS

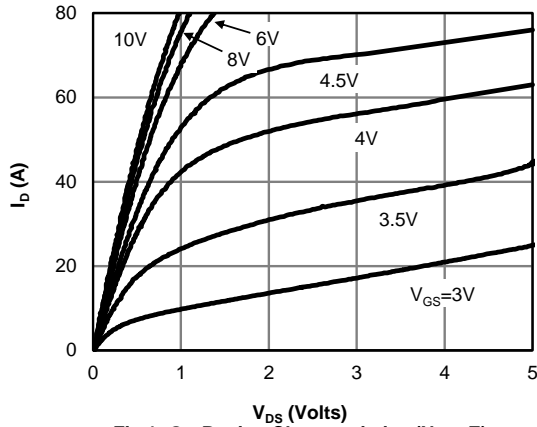

Figure 1: On-Region Characteristics (Note E)

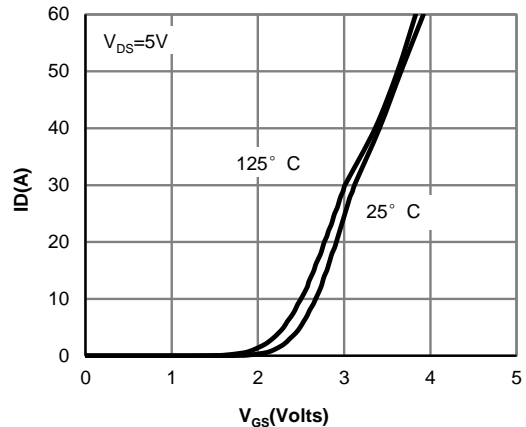

Figure 2: Transfer Characteristics (Note E)

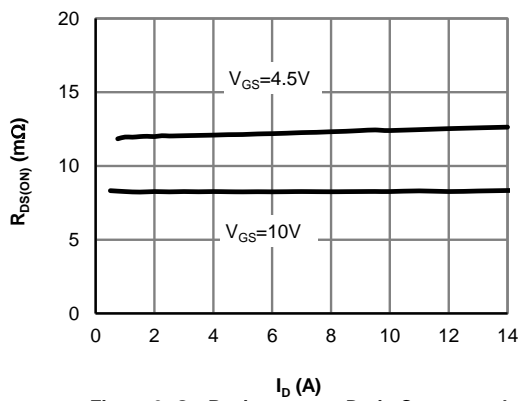

Figure 3: On-Resistance vs. Drain Current and Gate Voltage (Note E)

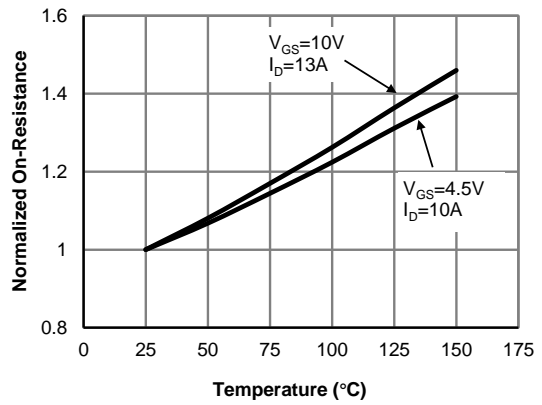

Figure 4: On-Resistance vs. Junction Temperature (Note E)

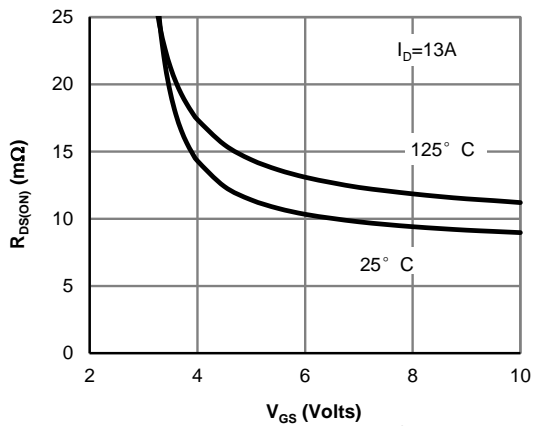

Figure 5: On-Resistance vs. Gate-Source Voltage (Note E)

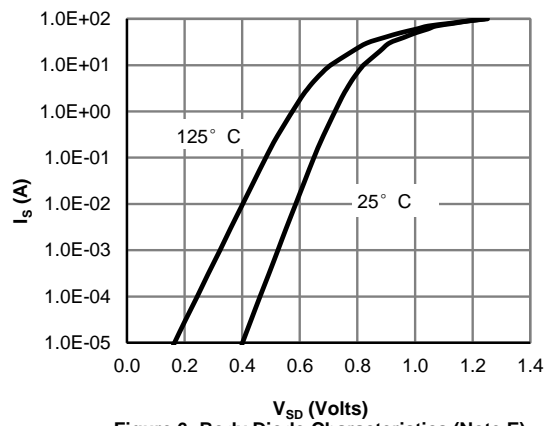

Figure 6: Body-Diode Characteristics (Note E)

Q1-CHANNEL: TYPICAL ELECTRICAL AND THERMAL CHARACTERISTICS

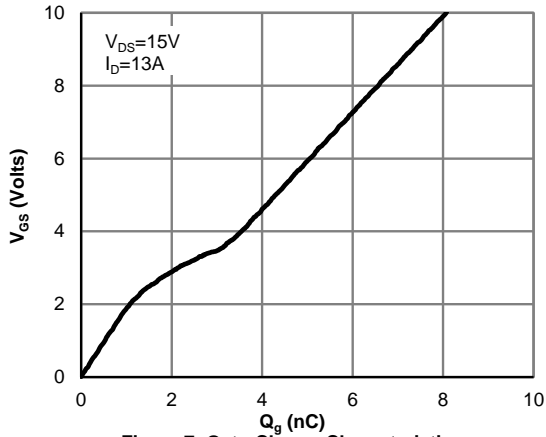

Figure 7: Gate-Charge Characteristics

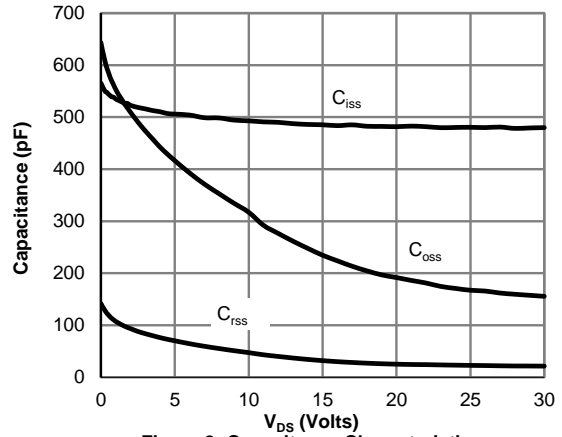

Figure 8: Capacitance Characteristics

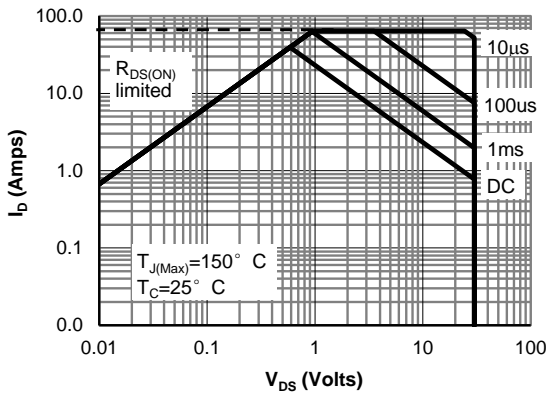

Figure 9: Maximum Forward Biased Safe Operating Area (Note F)

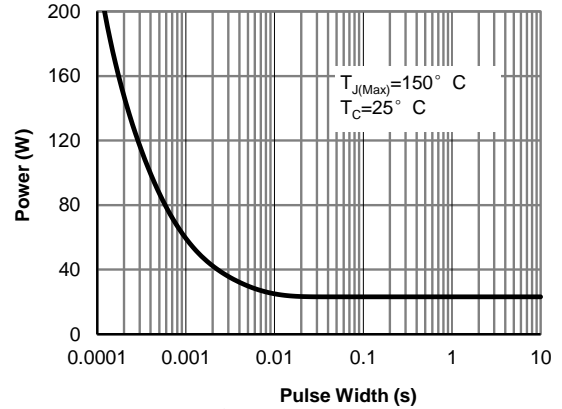

Figure 10: Single Pulse Power Rating Junction-to-Case (Note F)

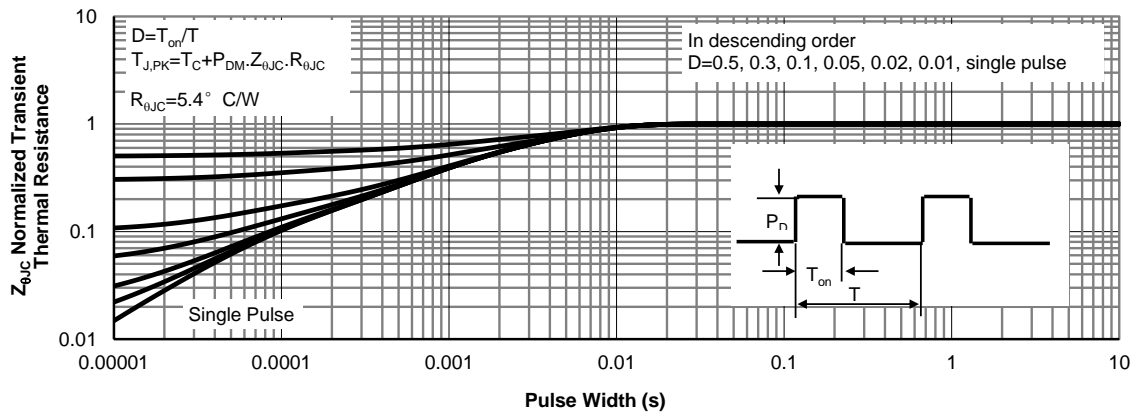

Figure 11: Normalized Maximum Transient Thermal Impedance (Note F)

Q1-CHANNEL: TYPICAL ELECTRICAL AND THERMAL CHARACTERISTICS

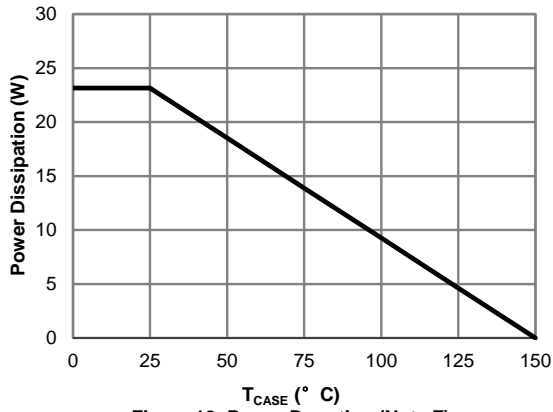

Figure 12: Power De-rating (Note F)

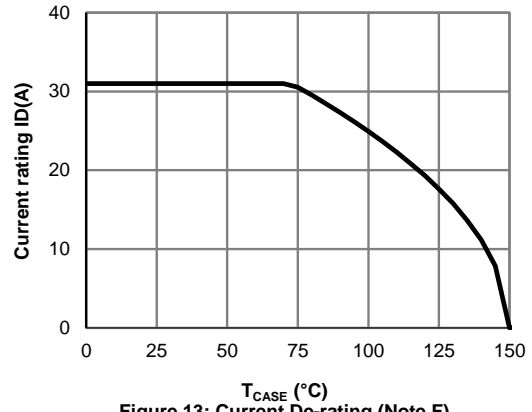

Figure 13: Current De-rating (Note F)

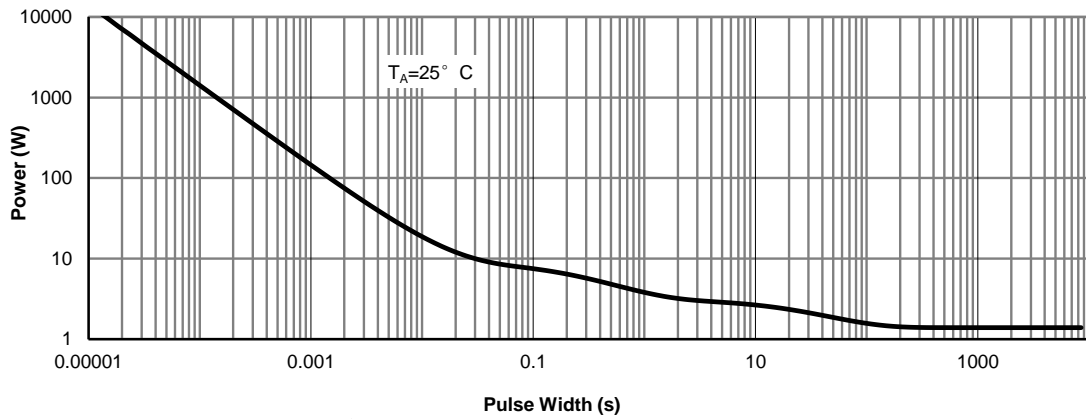

Figure 14: Single Pulse Power Rating Junction-to-Ambient (Note H)

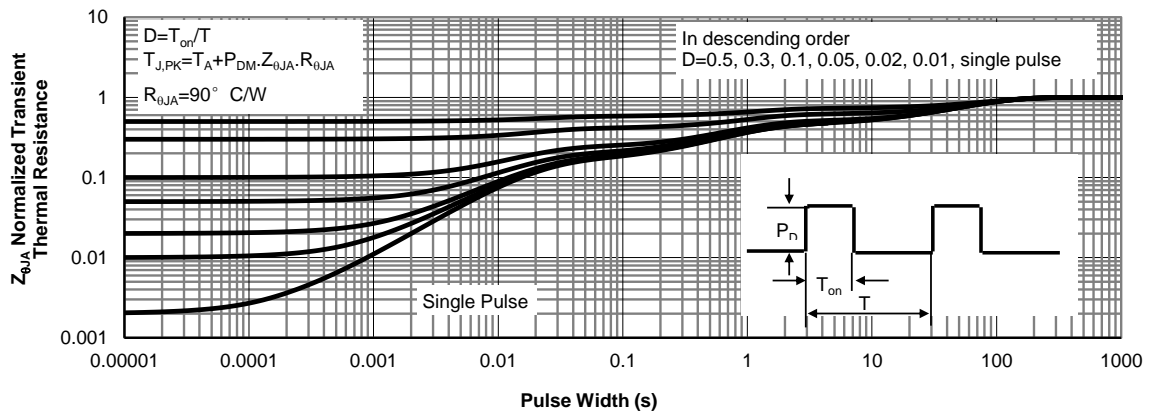

Figure 15: Normalized Maximum Transient Thermal Impedance (Note H)

Q2 Electrical Characteristics (T_J=25°C unless otherwise noted)

| Symbol | Parameter | Conditions | Min | Typ | Max | Units |
|-----------------------------|--|---|-----|------|--------|-------|
| STATIC PARAMETERS | | | | | | |
| BV _{DSS} | Drain-Source Breakdown Voltage | I _D =250μA, V _{GS} =0V | 30 | | | V |
| I _{DSS} | Zero Gate Voltage Drain Current | V _{DS} =30V, V _{GS} =0V T _J =55°C | | | 1 5 | μA |
| I _{GSS} | Gate-Body leakage current | V _{DS} =0V, V _{GS} = ±20V | | | 100 | nA |
| V _{GS(th)} | Gate Threshold Voltage | V _{DS} =V _{GS} I _D =250μA | 1.2 | 1.8 | 2.2 | V |
| R _{DS(on)} | Static Drain-Source On-Resistance | V _{GS} =10V, I _D =15A T _J =125°C | | 6.3 | 7.7 | mΩ |
| | | V _{GS} =4.5V, I _D =10A | | 8.4 | 10.3 | mΩ |
| g _{FS} | Forward Transconductance | V _{DS} =5V, I _D =15A | | 100 | | S |
| V _{SD} | Diode Forward Voltage | I _S =1A, V _{GS} =0V | | 0.7 | 1 | V |
| I _S | Maximum Body-Diode Continuous Current ^G | | | | 18 | A |
| DYNAMIC PARAMETERS | | | | | | |
| C _{iss} | Input Capacitance | V _{GS} =0V, V _{DS} =15V, f=1MHz | | 807 | | pF |
| C _{oss} | Output Capacitance | | | 314 | | pF |
| C _{rss} | Reverse Transfer Capacitance | | | 40 | | pF |
| R _g | Gate resistance | V _{GS} =0V, V _{DS} =0V, f=1MHz | 0.6 | 1.3 | 2 | Ω |
| SWITCHING PARAMETERS | | | | | | |
| Q _g (10V) | Total Gate Charge | V _{GS} =10V, V _{DS} =15V, I _D =15A | | 12.9 | 17.5 | nC |
| Q _g (4.5V) | Total Gate Charge | | | 6 | 8.5 | nC |
| Q _{gs} | Gate Source Charge | | | 2.1 | | nC |
| Q _{gd} | Gate Drain Charge | | | 3 | | nC |
| t _{D(on)} | Turn-On DelayTime | V _{GS} =10V, V _{DS} =15V, R _L =1Ω, R _{GEN} =3Ω | | 4.8 | | ns |
| t _r | Turn-On Rise Time | | | 3.3 | | ns |
| t _{D(off)} | Turn-Off DelayTime | | | 18.8 | | ns |
| t _f | Turn-Off Fall Time | | | 3.3 | | ns |
| t _{rr} | Body Diode Reverse Recovery Time | I _F =15A, dI/dt=500A/μs | | 11.3 | | ns |
| Q _{rr} | Body Diode Reverse Recovery Charge | I _F =15A, dI/dt=500A/μs | | 15 | | nC |

A. The value of R_{θJA} is measured with the device mounted on 1in² FR-4 board with 2oz. Copper, in a still air environment with T_A=25° C. The Power dissipation P_{DSM} is based on R_{θJA} t_s ≤ 10s value and the maximum allowed junction temperature of 150° C. The value in any given application depends on the user's specific board design.

B. The power dissipation P_D is based on T_{J(MAX)}=150° C, using junction-to-case thermal resistance, and is more useful in setting the upper dissipation limit for cases where additional heatsinking is used.

C. Repetitive rating, pulse width limited by junction temperature T_{J(MAX)}=150° C. Ratings are based on low frequency and duty cycles to keep initial T_J=25° C.

D. The R_{θJA} is the sum of the thermal impedance from junction to case R_{θJC} and case to ambient.

E. The static characteristics in Figures 1 to 6 are obtained using <300μs pulses, duty cycle 0.5% max.

F. These curves are based on the junction-to-case thermal impedance which is measured with the device mounted to a large heatsink, assuming a maximum junction temperature of T_{J(MAX)}=150° C. The SOA curve provides a single pulse rating.

G. These tests are performed with the device mounted on 1 in² FR-4 board with 2oz. Copper, in a still air environment with T_A=25° C.

APPLICATIONS OR USES AS CRITICAL COMPONENTS IN LIFE SUPPORT DEVICES OR SYSTEMS ARE NOT AUTHORIZED. AOS DOES NOT ASSUME ANY LIABILITY ARISING OUT OF SUCH APPLICATIONS OR USES OF ITS PRODUCTS. AOS RESERVES THE RIGHT TO MAKE CHANGES TO PRODUCT SPECIFICATIONS WITHOUT NOTICE. IT IS THE RESPONSIBILITY OF THE CUSTOMER TO EVALUATE SUITABILITY OF THE PRODUCT FOR THEIR INTENDED APPLICATION. CUSTOMER SHALL COMPLY WITH APPLICABLE LEGAL REQUIREMENTS, INCLUDING ALL APPLICABLE EXPORT CONTROL RULES, REGULATIONS AND LIMITATIONS.

AOS' products are provided subject to AOS' terms and conditions of sale which are set forth at:

http://www.aosmd.com/terms_and_conditions_of_sale

Q2-CHANNEL: TYPICAL ELECTRICAL AND THERMAL CHARACTERISTICS

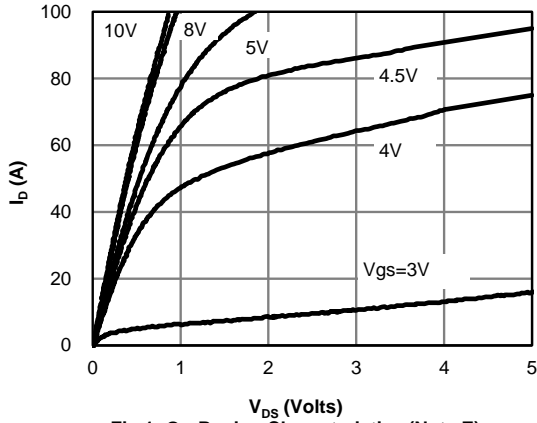

Figure 1: On-Region Characteristics (Note E)

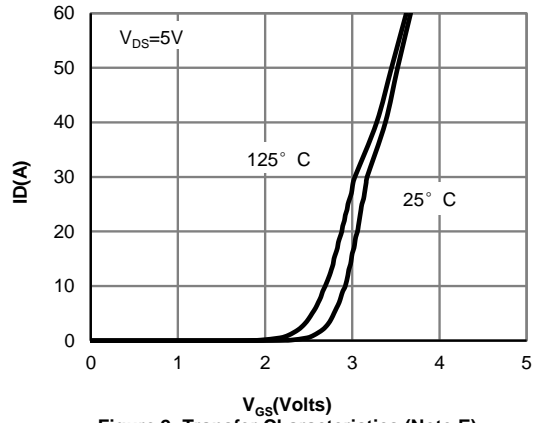

Figure 2: Transfer Characteristics (Note E)

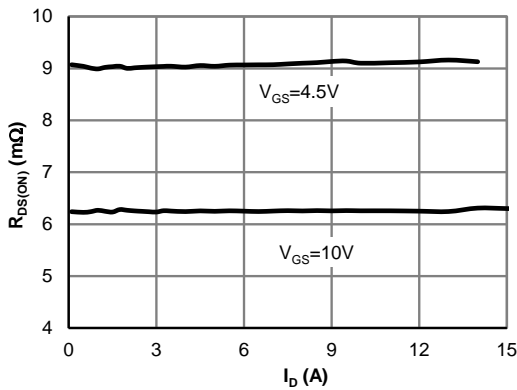

Figure 3: On-Resistance vs. Drain Current and Gate Voltage (Note E)

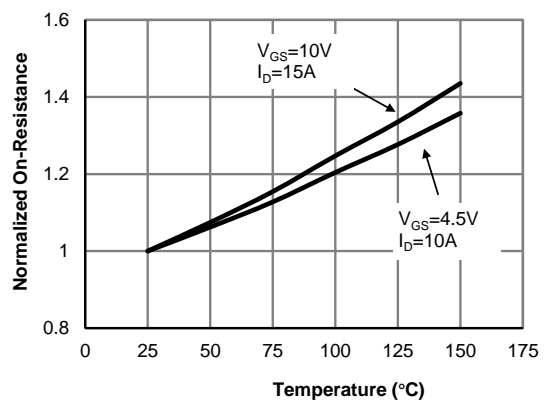

Figure 4: On-Resistance vs. Junction Temperature (Note E)

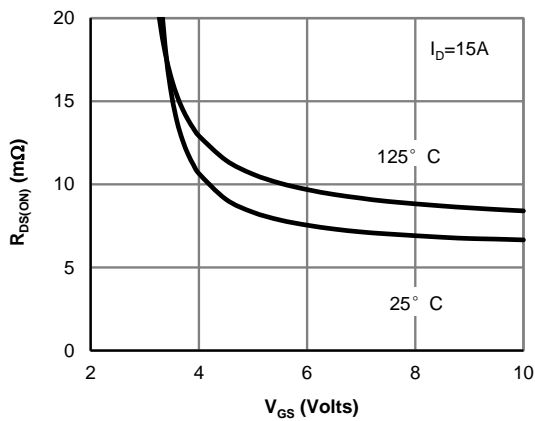

Figure 5: On-Resistance vs. Gate-Source Voltage (Note E)

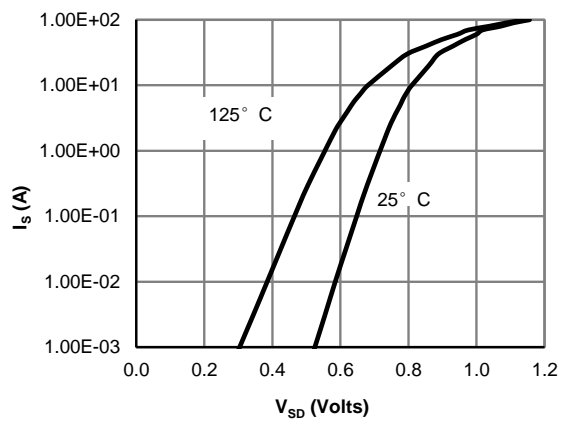

Figure 6: Body-Diode Characteristics (Note E)

Q2-CHANNEL: TYPICAL ELECTRICAL AND THERMAL CHARACTERISTICS

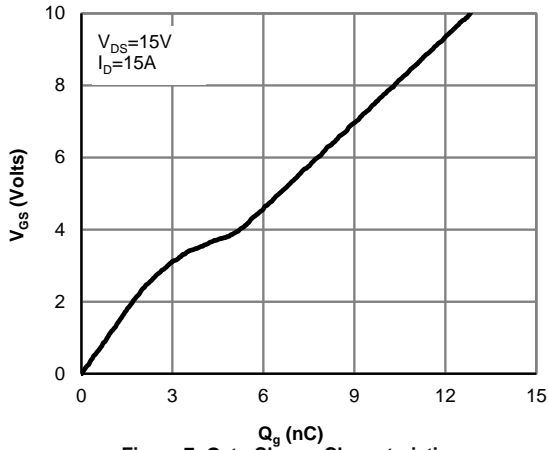

Figure 7: Gate-Charge Characteristics

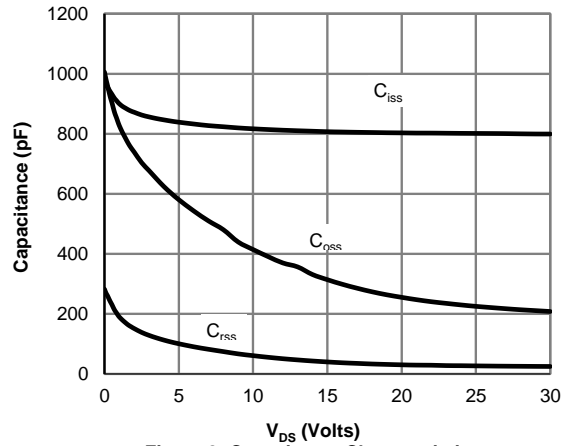

Figure 8: Capacitance Characteristics

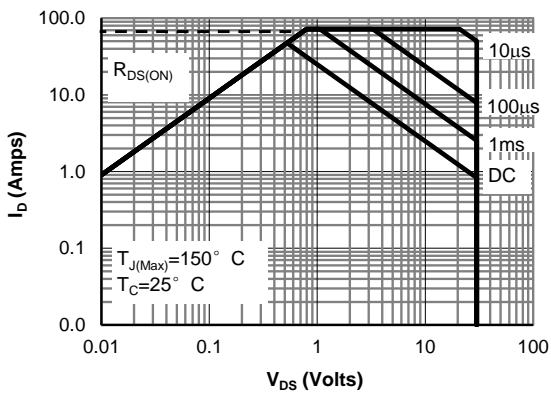

Figure 9: Maximum Forward Biased Safe Operating Area (Note F)

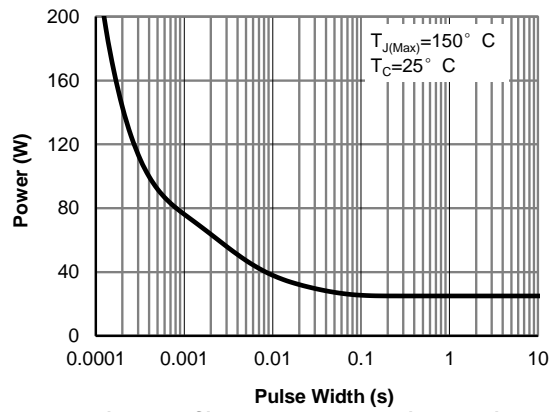

Figure 10: Single Pulse Power Rating Junction-to-Case (Note F)

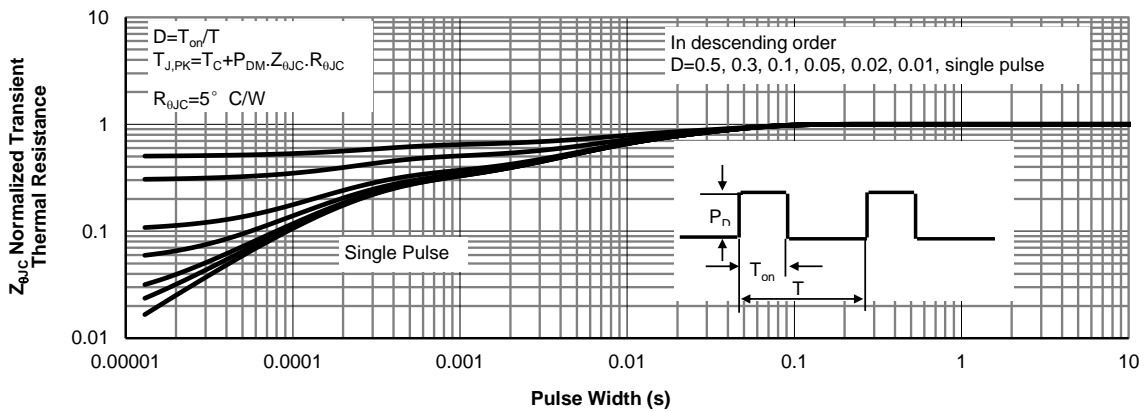

Figure 11: Normalized Maximum Transient Thermal Impedance (Note F)

Q2-CHANNEL: TYPICAL ELECTRICAL AND THERMAL CHARACTERISTICS

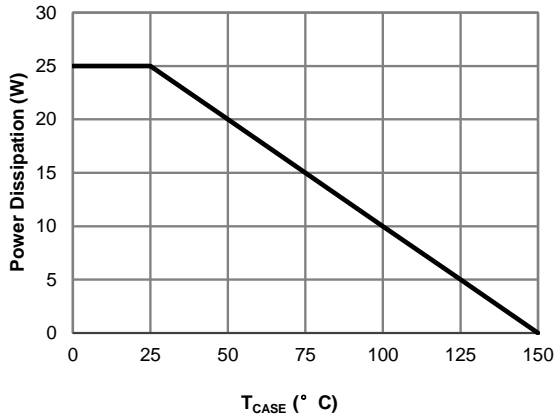

Figure 12: Power De-rating (Note F)

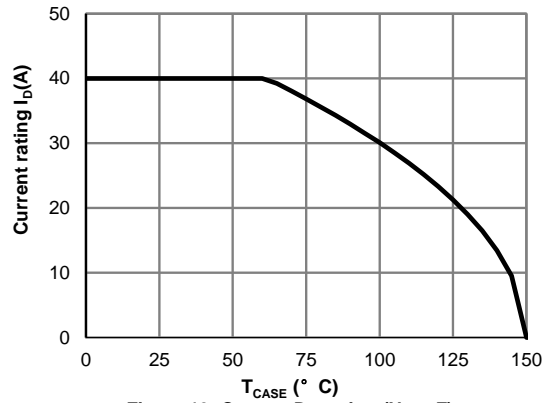

Figure 13: Current De-rating (Note F)

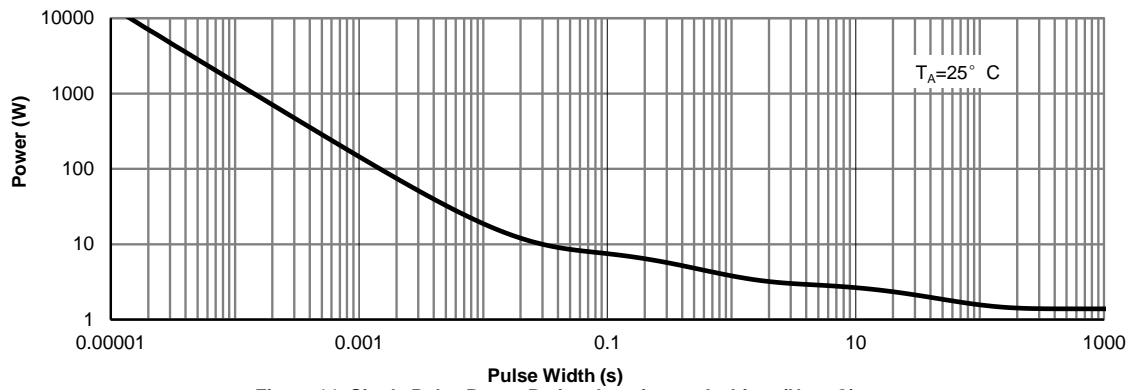

Figure 14: Single Pulse Power Rating Junction-to-Ambient (Note G)

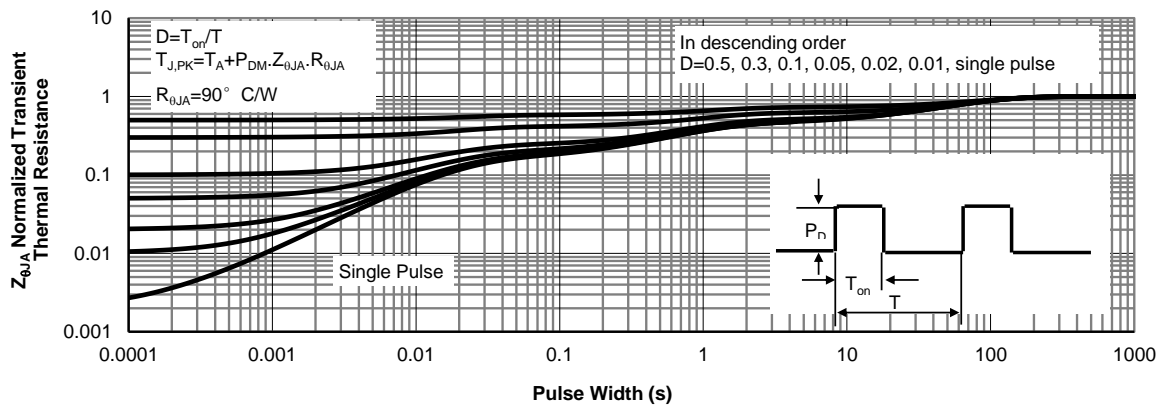
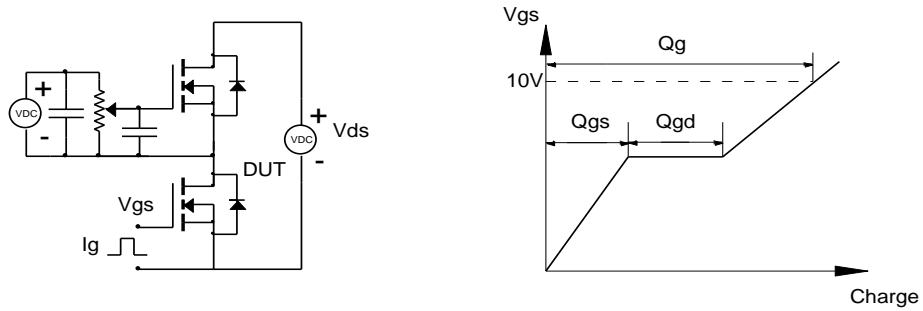
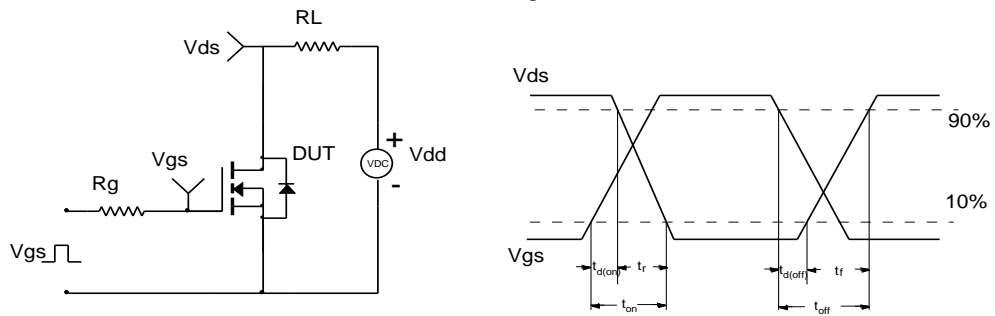

Figure 15: Normalized Maximum Transient Thermal Impedance (Note G)

Gate Charge Test Circuit & Waveform



Resistive Switching Test Circuit & Waveforms



Unclamped Inductive Switching (UIS) Test Circuit & Waveforms

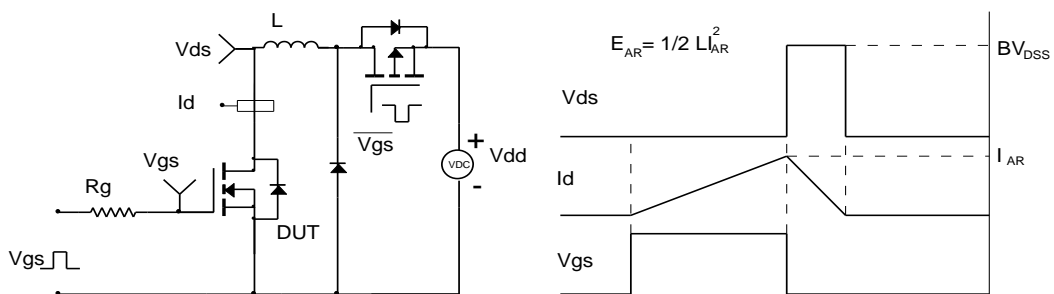

Diode Recovery Test Circuit & Waveforms

