

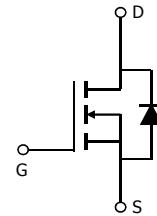
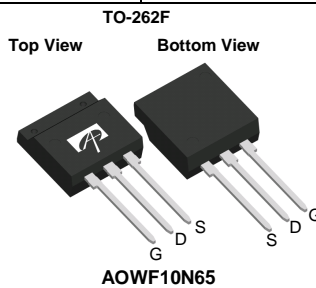
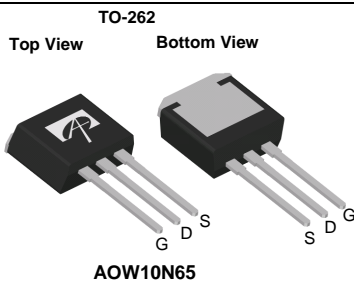
### General Description

The AOW10N65/AOWF10N65 is fabricated using an advanced high voltage MOSFET process that is designed to deliver high levels of performance and robustness in popular AC-DC applications. By providing low  $R_{DS(on)}$ ,  $C_{iss}$  and  $C_{rss}$  along with guaranteed avalanche capability this device can be adopted quickly into new and existing offline power supply designs.

### Product Summary

$V_{DS}$	750V@150°C
$I_D$ (at $V_{GS}=10V$ )	10A
$R_{DS(ON)}$ (at $V_{GS}=10V$ )	< 1Ω

100% UIS Tested  
 100%  $R_g$  Tested



### Absolute Maximum Ratings $T_A=25^\circ\text{C}$ unless otherwise noted

Parameter	Symbol	AOW10N65	AOWF10N65	Units
Drain-Source Voltage	$V_{DS}$	650		V
Gate-Source Voltage	$V_{GS}$	±30		V
Continuous Drain Current	$I_D$	$T_C=25^\circ\text{C}$	10	10*
		$T_C=100^\circ\text{C}$	6.2	6.2*
Pulsed Drain Current <sup>C</sup>	$I_{DM}$	36		A
Avalanche Current <sup>C</sup>	$I_{AR}$	3.4		A
Repetitive avalanche energy <sup>C</sup>	$E_{AR}$	173		mJ
Single pulsed avalanche energy <sup>G</sup>	$E_{AS}$	347		mJ
Peak diode recovery dv/dt	dv/dt	5		V/ns
Power Dissipation <sup>B</sup>	$P_D$	$T_C=25^\circ\text{C}$	250	28
		Derate above 25°C	2	0.22
Junction and Storage Temperature Range	$T_J, T_{STG}$	-55 to 150		°C
Maximum lead temperature for soldering purpose, 1/8" from case for 5 seconds	$T_L$	300		°C

### Thermal Characteristics

Parameter	Symbol	AOW10N65	AOWF10N65	Units
Maximum Junction-to-Ambient <sup>A,D</sup>	$R_{\theta JA}$	65	65	°C/W
Maximum Case-to-sink <sup>A</sup>	$R_{\theta CS}$	0.5	--	°C/W
Maximum Junction-to-Case	$R_{\theta JC}$	0.5	4.5	°C/W

\* Drain current limited by maximum junction temperature.

**Electrical Characteristics (T<sub>J</sub>=25°C unless otherwise noted)**

Symbol	Parameter	Conditions	Min	Typ	Max	Units
<b>STATIC PARAMETERS</b>						
BV <sub>DSS</sub>	Drain-Source Breakdown Voltage	I <sub>D</sub> =250μA, V <sub>GS</sub> =0V, T <sub>J</sub> =25°C	650			V
		I <sub>D</sub> =250μA, V <sub>GS</sub> =0V, T <sub>J</sub> =150°C		750		
BV <sub>DSS</sub> /ΔT <sub>J</sub>	Zero Gate Voltage Drain Current	I <sub>D</sub> =250μA, V <sub>GS</sub> =0V		0.75		V/°C
I <sub>DSS</sub>	Zero Gate Voltage Drain Current	V <sub>DS</sub> =650V, V <sub>GS</sub> =0V			1	μA
		V <sub>DS</sub> =520V, T <sub>J</sub> =125°C			10	
I <sub>GSS</sub>	Gate-Body leakage current	V <sub>DS</sub> =0V, V <sub>GS</sub> =±30V			±100	nA
V <sub>GS(th)</sub>	Gate Threshold Voltage	V <sub>DS</sub> =5V I <sub>D</sub> =250μA	3	4	4.5	V
R <sub>DS(on)</sub>	Static Drain-Source On-Resistance	V <sub>GS</sub> =10V, I <sub>D</sub> =5A		0.77	1	Ω
g <sub>FS</sub>	Forward Transconductance	V <sub>DS</sub> =40V, I <sub>D</sub> =5A		13		S
V <sub>SD</sub>	Diode Forward Voltage	I <sub>S</sub> =1A, V <sub>GS</sub> =0V		0.73		V
I <sub>S</sub>	Maximum Body-Diode Continuous Current				10	A
I <sub>SM</sub>	Maximum Body-Diode Pulsed Current				36	A
<b>DYNAMIC PARAMETERS</b>						
C <sub>iss</sub>	Input Capacitance	V <sub>GS</sub> =0V, V <sub>DS</sub> =25V, f=1MHz	1095	1369	1645	pF
C <sub>oss</sub>	Output Capacitance		80	118	154	pF
C <sub>rss</sub>	Reverse Transfer Capacitance		6	10	14	pF
R <sub>g</sub>	Gate resistance	V <sub>GS</sub> =0V, V <sub>DS</sub> =0V, f=1MHz	1.7	3.5	5.5	Ω
<b>SWITCHING PARAMETERS</b>						
Q <sub>g</sub>	Total Gate Charge	V <sub>GS</sub> =10V, V <sub>DS</sub> =520V, I <sub>D</sub> =10A	22	27.7	33	nC
Q <sub>gs</sub>	Gate Source Charge		6	7.4	9	nC
Q <sub>gd</sub>	Gate Drain Charge		5.5	11.3	17	nC
t <sub>D(on)</sub>	Turn-On DelayTime	V <sub>GS</sub> =10V, V <sub>DS</sub> =325V, I <sub>D</sub> =10A, R <sub>G</sub> =25Ω		30		ns
t <sub>r</sub>	Turn-On Rise Time			61		ns
t <sub>D(off)</sub>	Turn-Off DelayTime			74		ns
t <sub>f</sub>	Turn-Off Fall Time			53		ns
t <sub>rr</sub>	Body Diode Reverse Recovery Time		I <sub>F</sub> =10A, di/dt=100A/μs, V <sub>DS</sub> =100V	255	320	385
Q <sub>rr</sub>	Body Diode Reverse Recovery Charge	I <sub>F</sub> =10A, di/dt=100A/μs, V <sub>DS</sub> =100V	4.8	6	7.2	μC

A. The value of R<sub>θJA</sub> is measured with the device in a still air environment with T<sub>A</sub>=25° C.

B. The power dissipation P<sub>D</sub> is based on T<sub>J(MAX)</sub>=150° C, using junction-to-case thermal resistance, and is more useful in setting the upper dissipation limit for cases where additional heatsinking is used.

C. Repetitive rating, pulse width limited by junction temperature T<sub>J(MAX)</sub>=150° C, Ratings are based on low frequency and duty cycles to keep initial T<sub>J</sub>=25° C.

D. The R<sub>θJA</sub> is the sum of the thermal impedance from junction to case R<sub>θJC</sub> and case to ambient.

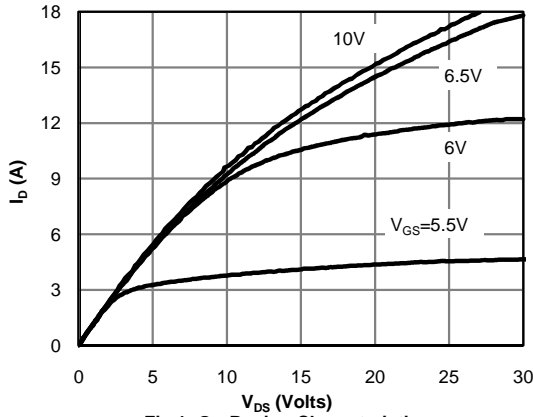
E. The static characteristics in Figures 1 to 6 are obtained using <300 μs pulses, duty cycle 0.5% max.

F. These curves are based on the junction-to-case thermal impedance which is measured with the device mounted to a large heatsink, assuming a maximum junction temperature of T<sub>J(MAX)</sub>=150° C. The SOA curve provides a single pulse rating.

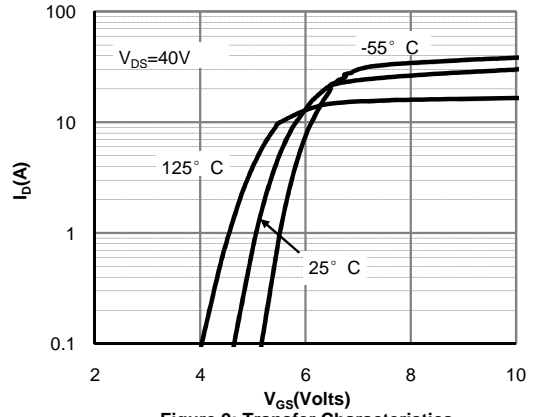
G. L=60mH, I<sub>AS</sub>=3.4A, V<sub>DD</sub>=150V, R<sub>G</sub>=25Ω, Starting T<sub>J</sub>=25° C

THIS PRODUCT HAS BEEN DESIGNED AND QUALIFIED FOR THE CONSUMER MARKET. APPLICATIONS OR USES AS CRITICAL COMPONENTS IN LIFE SUPPORT DEVICES OR SYSTEMS ARE NOT AUTHORIZED. AOS DOES NOT ASSUME ANY LIABILITY ARISING OUT OF SUCH APPLICATIONS OR USES OF ITS PRODUCTS. AOS RESERVES THE RIGHT TO IMPROVE PRODUCT DESIGN, FUNCTIONS AND RELIABILITY WITHOUT NOTICE.

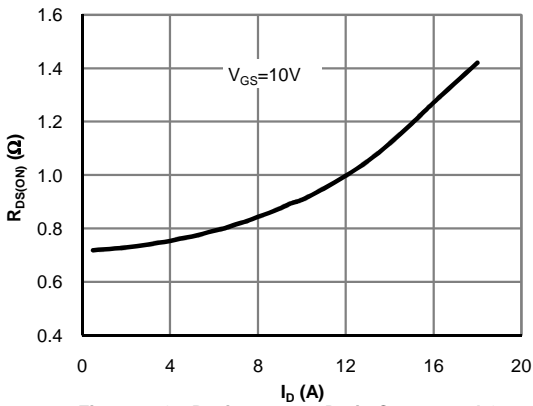
**TYPICAL ELECTRICAL AND THERMAL CHARACTERISTICS**



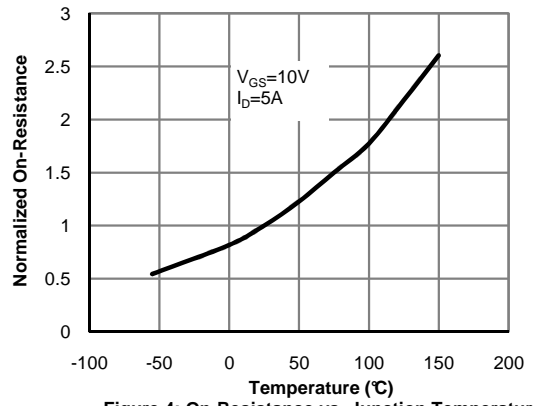
**Fig 1: On-Region Characteristics**



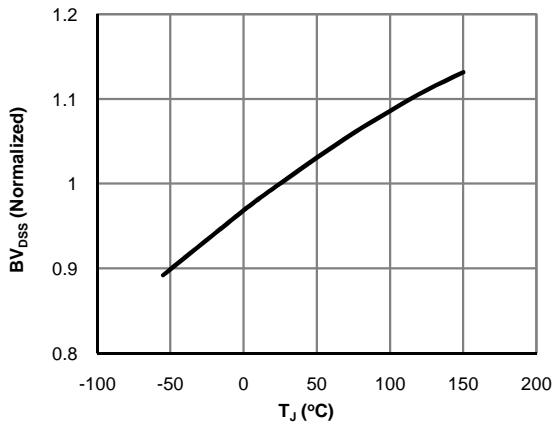
**Figure 2: Transfer Characteristics**



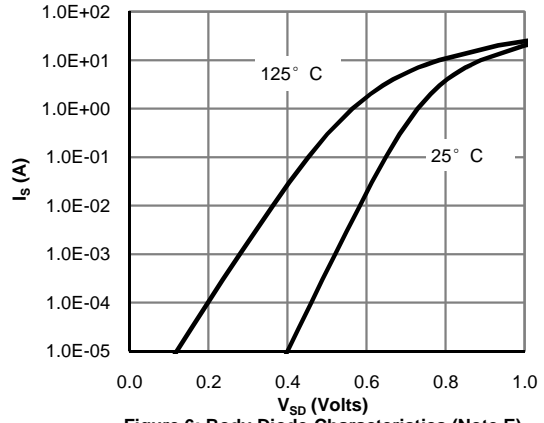
**Figure 3: On-Resistance vs. Drain Current and Gate Voltage**



**Figure 4: On-Resistance vs. Junction Temperature**

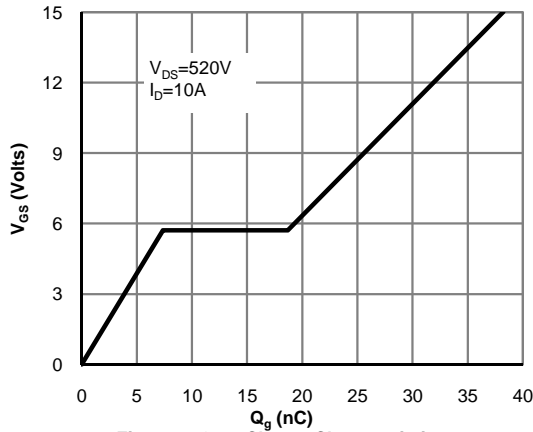


**Figure 5: Break Down vs. Junction Temperature**

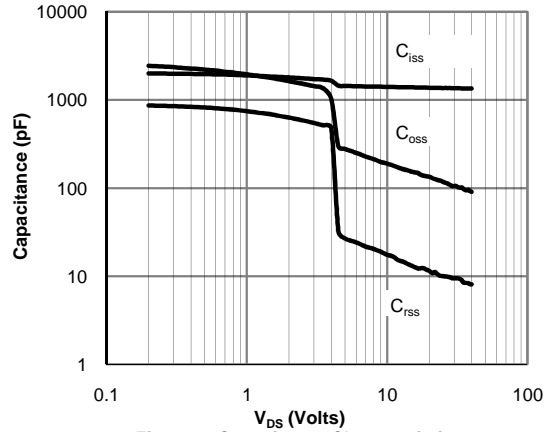


**Figure 6: Body-Diode Characteristics (Note E)**

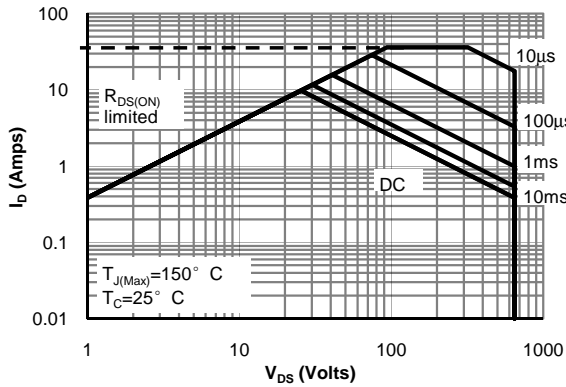
**TYPICAL ELECTRICAL AND THERMAL CHARACTERISTICS**



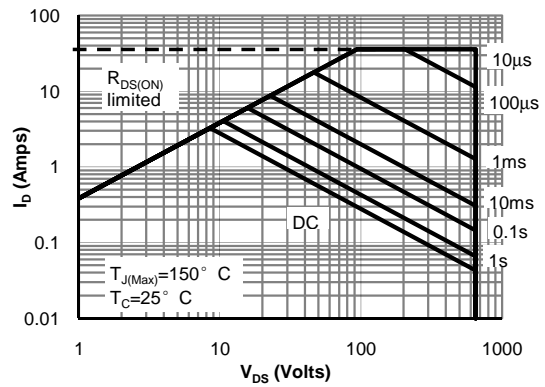
**Figure 7: Gate-Charge Characteristics**



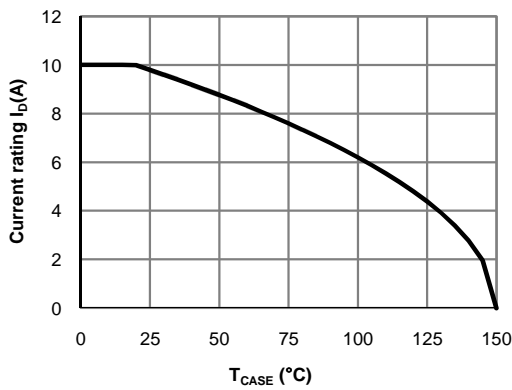
**Figure 8: Capacitance Characteristics**



**Figure 9: Maximum Forward Biased Safe Operating Area for AOW10N65 (Note F)**

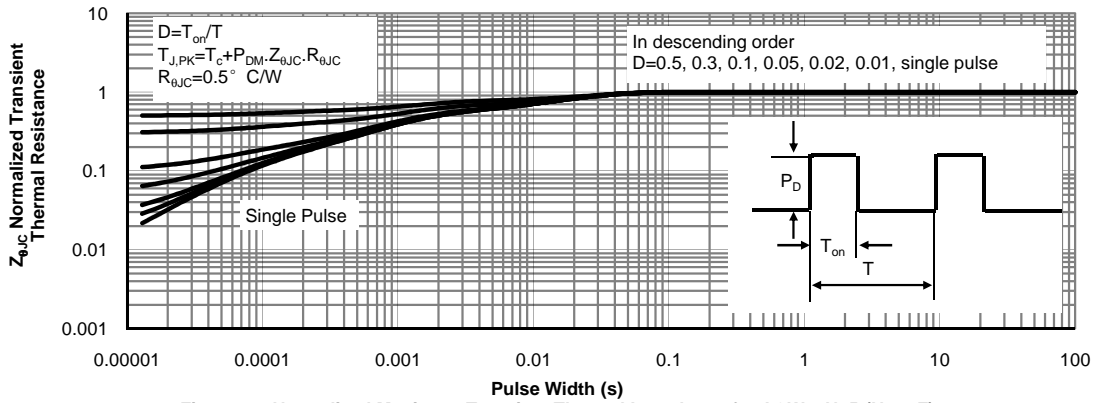


**Figure 10: Maximum Forward Biased Safe Operating Area for AOWF10N65 (Note F)**

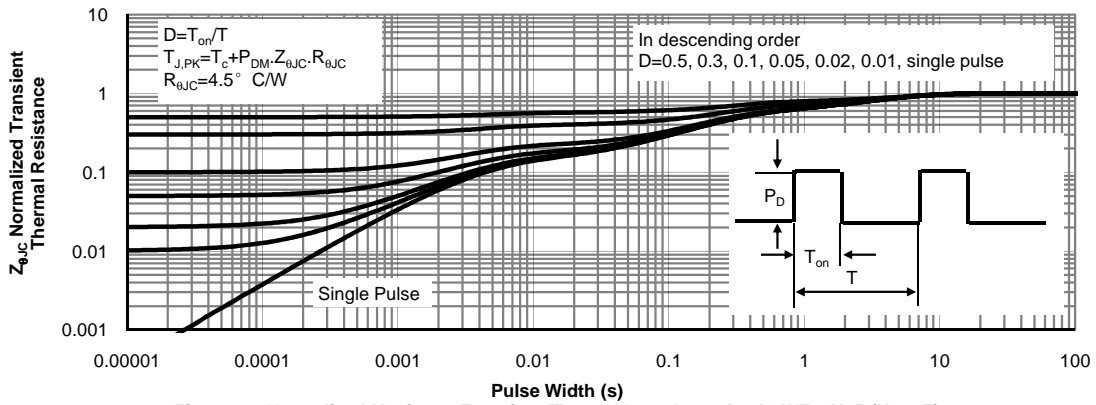


**Figure 11: Current De-rating (Note B)**

**TYPICAL ELECTRICAL AND THERMAL CHARACTERISTICS**

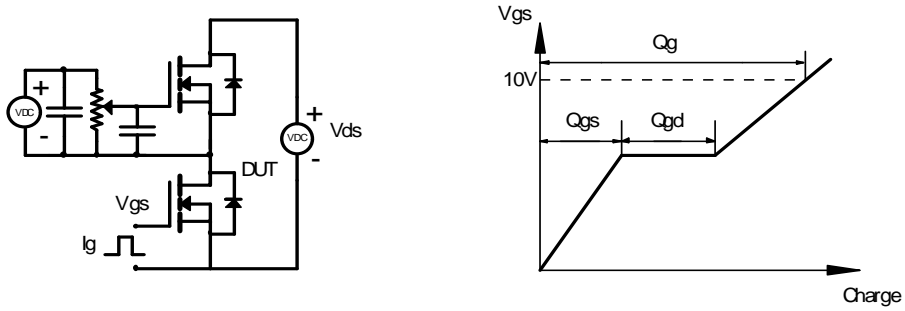


**Figure 12: Normalized Maximum Transient Thermal Impedance for AOW10N65 (Note F)**

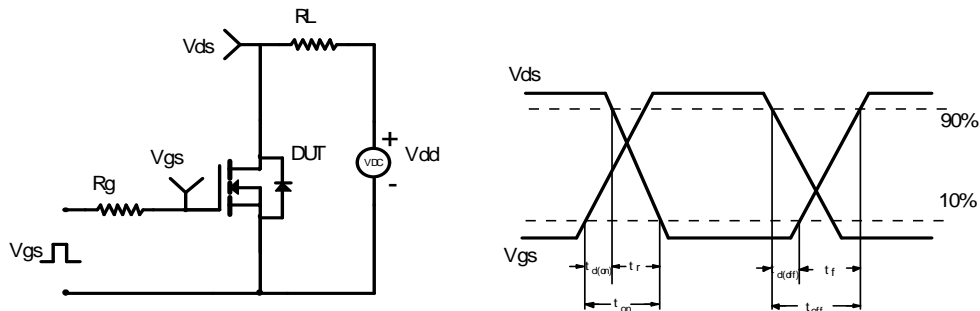


**Figure 13: Normalized Maximum Transient Thermal Impedance for AOWF10N65 (Note F)**

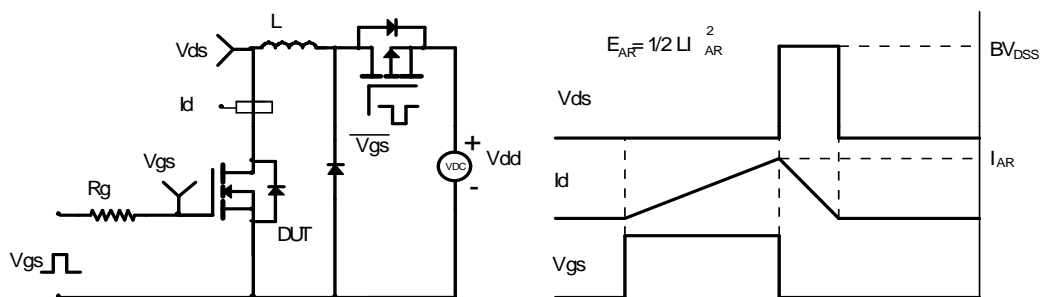
Gate Charge Test Circuit & Waveform



Resistive Switching Test Circuit & Waveforms



Unclamped Inductive Switching (UIS) Test Circuit & Waveforms



Diode Recovery Test Circuit & Waveforms

