

## General Description

The AOZ1336DI is a single channel load switch with typical 27mΩ on-resistance in a small package. It contains an n-channel MOSFET for up to 5.5V input voltage operation and 4A current channel with 2.5V to 5V bias supply. The load switch is independently controlled by a low voltage control signal through ON pin.

The AOZ1336DI integrates an internal 220Ω load resistor for quick output discharge when load switch is off. The optional external capacitor connected CT for output slew rate control.

The AOZ1336DI is available in a 2mm x 2mm DFN-8L package with bottom thermal pad and is rated over a -40°C to +85°C ambient temperature range.

## Features

- 0.8V to 5.5V input voltage range
- 4A continuous current
- Low  $R_{DS(ON)}$  internal NFETs  
– 27mΩ at  $V_{BIAS} = 2.5V$  to 5V &  $V_{BIAS} \geq V_{IN}$
- 50μA low quiescent current
- Adjustable rise time
- 2.5V to 5V bias voltage
- Integrated quick output discharge resistor
- Thermally enhanced 2mm x 2mm DFN-8L package

## Applications

- Portable computers
- Ultrabooks
- Tablet PC
- Set top boxes
- LCD TVs
- Telecom/Networking/Datacom equipment
- SSD
- Consumer electronics



## Typical Application

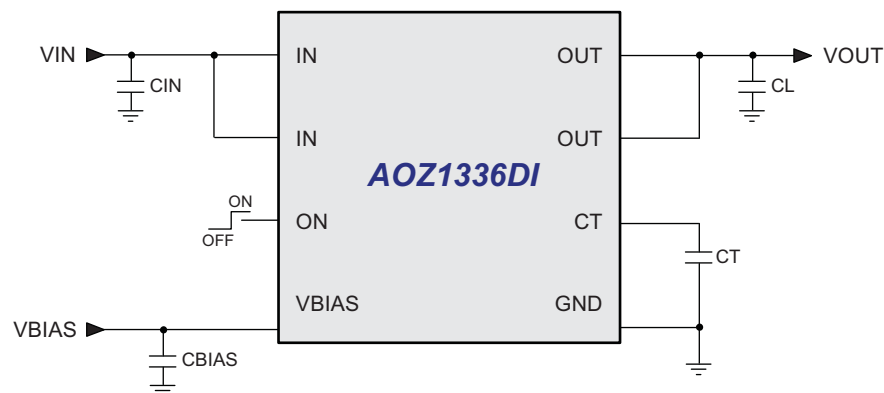

## Ordering Information

| Part Number | Temperature Range | Package          | Environmental |
|-------------|-------------------|------------------|---------------|
| AOZ1336DI   | -40°C to +85°C    | 2mm x 2mm DFN-8L | Green         |



All AOS products are offered in packages with Pb-free plating and compliant to RoHS standards. Please visit [www.aosmd.com/media/AOSGreenPolicy.pdf](http://www.aosmd.com/media/AOSGreenPolicy.pdf) for additional information.

## Pin Configuration

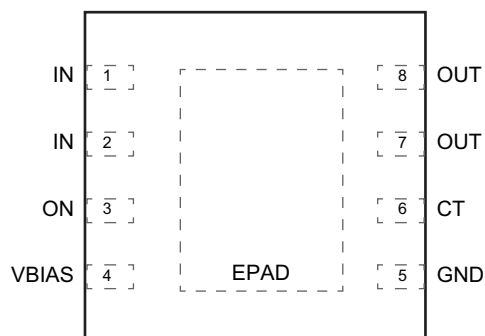

2mm x 2mm DFN-8  
(Top View)

## Pin Description

| Pin Number | Pin Name    | Pin Function  |
|------------|-------------|---|
| 1, 2       | IN          | Load Switch Input. Bypass IN and GND with ceramic capacitor.                                      |
| 3          | ON          | Enable Input. Load switch is on when ON is pulled high. Load switch is off when ON is pulled low. |
| 4          | VBIAS       | Supply input for the device.  |
| 5          | GND         | Ground.   |
| 6          | CT          | Load switch slew rate control.  |
| 7, 8       | OUT         | Load switch output.   |
| EPAD       | Exposed Pad | The exposed bottom pad must be connected to GND.  |

### Functional Block Diagram

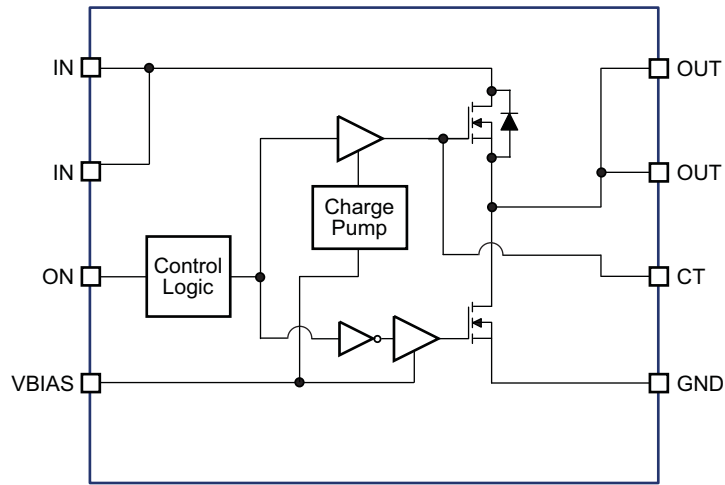

## Absolute Maximum Ratings

Exceeding the Absolute Maximum ratings may damage the device.

| Parameter                      | Rating          |
|--------------------------------|-----------------|
| IN, ON, VBIAS, OUT to GND      | -0.3V to 6V     |
| Junction Temperature ( $T_J$ ) | +150°C          |
| Storage Temperature ( $T_S$ )  | -65°C to +150°C |
| ESD Rating HBM/CDM             | 2kV/1kV         |

## Recommend Operating Ratings

The device is not guaranteed to operate beyond the Maximum Operating Ratings.

| Parameter                     | Rating         |
|-------------------------------|----------------|
| Supply Voltage ( $V_{IN}$ )   | 5.5V           |
| Ambient Temperature ( $T_A$ ) | -40°C to +85°C |
| Package Thermal Resistance    |                |
| 2x2 DFN-8 ( $\theta_{JC}$ )   | 12°C/W         |
| 2x2 DFN-8 ( $\theta_{JA}$ )   | 90°C/W         |

## Electrical Characteristics

$T_A = 25^\circ\text{C}$ ,  $V_{BIAS} = 5\text{V}$ , unless otherwise specified. Specifications in **BOLD** indicate a temperature range of -40°C to +85°C.

| Symbol                         | Parameter                              | Conditions  | Min. | Typ. | Max.       | Units         |
|--------------------------------|--|---|------|------|------------|---------------|
| $V_{IN}$                       | IN Supply Voltage                      |   | 0.8  |      | $V_{BIAS}$ | V             |
| $V_{BIAS}$                     | VBIAS Supply Voltage                   |   | 2.5  |      | 5.5        | V             |
| $I_q$                          | Quiescent Supply Current of $V_{BIAS}$ | $I_{OUT} = 0\text{V}$ , $V_{ON} = 0\text{V}$ ,<br>$V_{IN} = V_{ON} = 5\text{V}$ |      | 50   | 75         | $\mu\text{A}$ |
| $I_{OFF}$                      | VBIAS Shutdown Supply Current          | $V_{ON} = 0\text{V}$ , $V_{OUT} = 0\text{V}$                                    |      | 1    | 2          | $\mu\text{A}$ |
| $I_D$                          | Maximum Continuous Current             | $V_{IN} = V_{ON} = 5\text{V}$   |      | 4    |            | A             |
| $I_{PLS}$                      | Maximum Pulsed Switch Current          | $V_{IN} = V_{ON} = 5\text{V}$<br>Pulse < 300 $\mu\text{s}$ , 2% Duty Cycle      |      | 6    |            | A             |
| $I_{INOFF}$                    | IN Shutdown Supply Current             | $V_{ON} = 0\text{V}$ , $V_{OUT} = 0\text{V}$ , $V_{IN} = 5\text{V}$             |      | 2.1  | 8          | $\mu\text{A}$ |
|                                |  | $V_{ON} = 0\text{V}$ , $V_{OUT} = 0\text{V}$ , $V_{IN} = 3.3\text{V}$           |      | 0.3  | 3          |               |
|                                |  | $V_{ON} = 0\text{V}$ , $V_{OUT} = 0\text{V}$ , $V_{IN} = 1.8\text{V}$           |      | 0.07 | 2          |               |
|                                |  | $V_{ON} = 0\text{V}$ , $V_{OUT} = 0\text{V}$ , $V_{IN} = 0.8\text{V}$           |      | 0.04 | 1          |               |
| $I_{ON}$                       | ON Leakage Current                     | $V_{ON} = 5\text{V}$  |      |      | 1          | $\mu\text{A}$ |
| $V_{ONH}$                      | ON High Level Voltage                  | $V_{IN} = 0.8\text{V}$ to 5V  | 1.2  |      |            | V             |
| $V_{ONL}$                      | ON Low Level Voltage                   | $V_{IN} = 0.8\text{V}$ to 5V  |      |      | 0.5        | V             |
| <b>Switching ON Resistance</b> |  |   |      |      |            |               |
| $R_{ON}$                       | Switch ON-State Resistance             | $I_{OUT} = -200\text{mA}$ , $V_{IN} = 0.8\text{V}$ to 5V                        |      | 27   | 33         | m $\Omega$    |
| $R_{PD}$                       | Output Pull-Down Resistance            | $I_{OUT} = 15\text{mA}$ , $V_{IN} = 5\text{V}$ , $V_{ON} = 0\text{V}$           |      | 220  | 300        | $\Omega$      |

### Note:

Greater on-resistance if  $V_{IN} > V_{BIAS}$ .

## Switching Characteristics

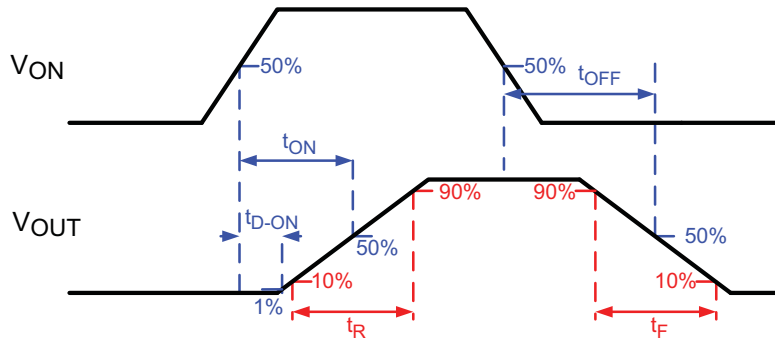

Test conditions: T<sub>A</sub> = 25°C, C<sub>IN</sub> = 1μF, C<sub>T</sub> = 1nF, C<sub>L</sub> = 0.1μF, R<sub>L</sub> = 10Ω (unless otherwise specified).

| Symbol                                | Parameter          | Min. | Typ. | Max. | Units |
|---------------------------------------|--------------------|------|------|------|-------|
| <b>VIN = 5V, VBIAS = VON = 5V</b>     |                    |      |      |      |       |
| t <sub>ON</sub>                       | Turn-ON Time       |      | 1420 |      | μs    |
| t <sub>D-ON</sub>                     | Turn-ON Delay time |      | 450  |      |       |
| t <sub>R</sub>                        | Turn-ON Rise Time  |      | 1740 |      |       |
| t <sub>OFF</sub>                      | Turn-OFF Time      |      | 7.7  |      |       |
| t <sub>F</sub>                        | Turn-OFF Fall Time |      | 2.5  |      |       |
| <b>VIN = 0.8V, VBIAS = VON = 5V</b>   |                    |      |      |      |       |
| t <sub>ON</sub>                       | Turn-ON Time       |      | 620  |      | μs    |
| t <sub>D-ON</sub>                     | Turn-ON Delay time |      | 450  |      |       |
| t <sub>R</sub>                        | Turn-ON Rise Time  |      | 280  |      |       |
| t <sub>OFF</sub>                      | Turn-OFF Time      |      | 89   |      |       |
| t <sub>F</sub>                        | Turn-OFF Fall Time |      | 10   |      |       |
| <b>VIN = 2.5V, VBIAS = VON = 2.5V</b> |                    |      |      |      |       |
| t <sub>ON</sub>                       | Turn-ON Time       |      | 2100 |      | μs    |
| t <sub>D-ON</sub>                     | Turn-ON Delay time |      | 780  |      |       |
| t <sub>R</sub>                        | Turn-ON Rise Time  |      | 2200 |      |       |
| t <sub>OFF</sub>                      | Turn-OFF Time      |      | 8    |      |       |
| t <sub>F</sub>                        | Turn-OFF Fall Time |      | 2.5  |      |       |
| <b>VIN = 0.8V, VBIAS = VON = 2.5V</b> |                    |      |      |      |       |
| t <sub>ON</sub>                       | Turn-ON Time       |      | 1250 |      | μs    |
| t <sub>D-ON</sub>                     | Turn-ON Delay time |      | 730  |      |       |
| t <sub>R</sub>                        | Turn-ON Rise Time  |      | 750  |      |       |
| t <sub>OFF</sub>                      | Turn-OFF Time      |      | 76   |      |       |
| t <sub>F</sub>                        | Turn-OFF Fall Time |      | 10   |      |       |

## Typical Characteristics

**Quiescent Current vs. VBIAS**  
(VIN=VBIAS, VON=5V)

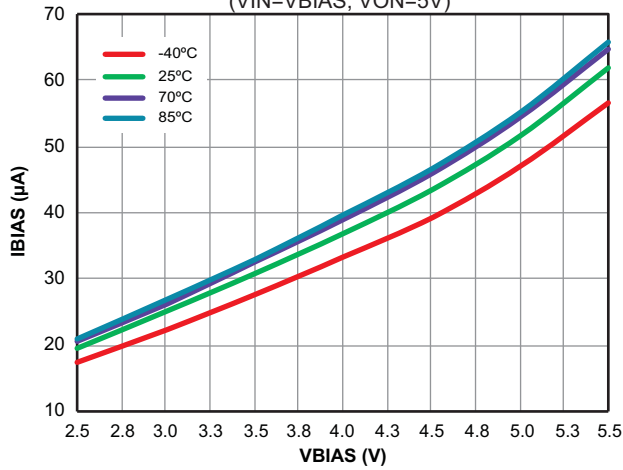

**RPD vs. VIN**  
(VBIAS=5.5V)

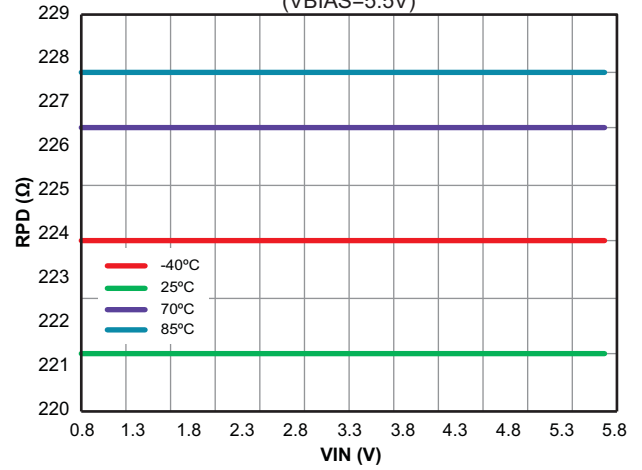

**RDSON vs. VIN**  
(VBIAS=2.5V, IOUT=-200mA)

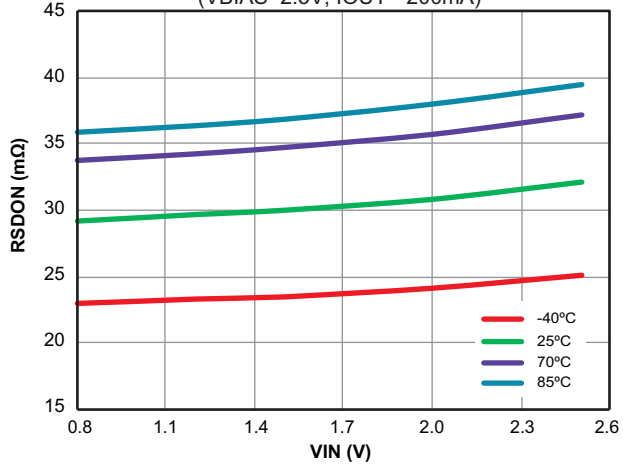

**VOUT vs. VON**  
(TA=25°C, VOUT=2V)

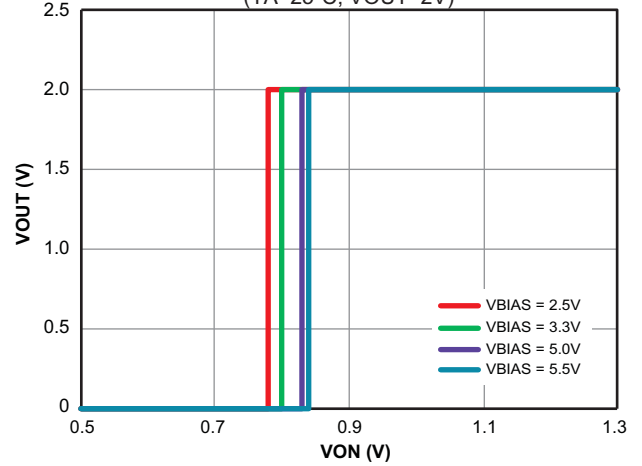

**RDSON vs. VIN**  
(VBIAS=5.5V, IOUT=-200mA)

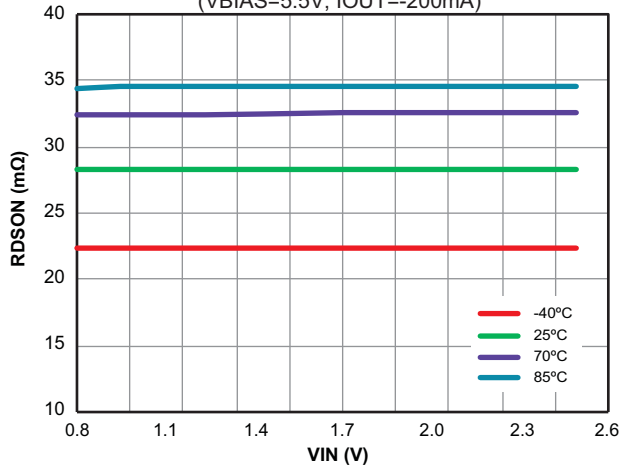

Typical Characteristics (Continued)

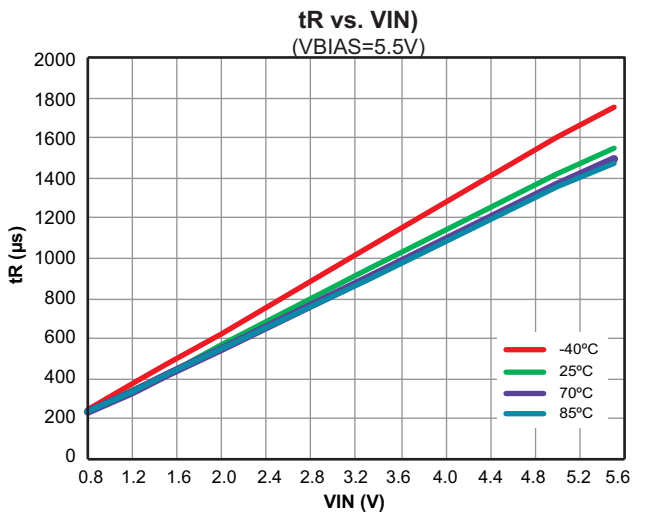
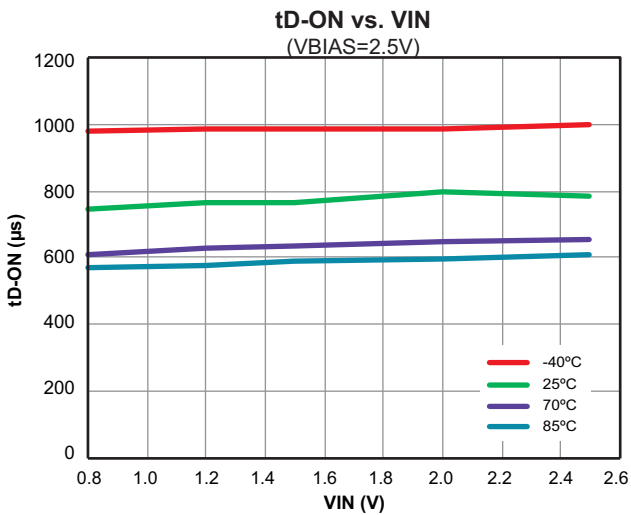
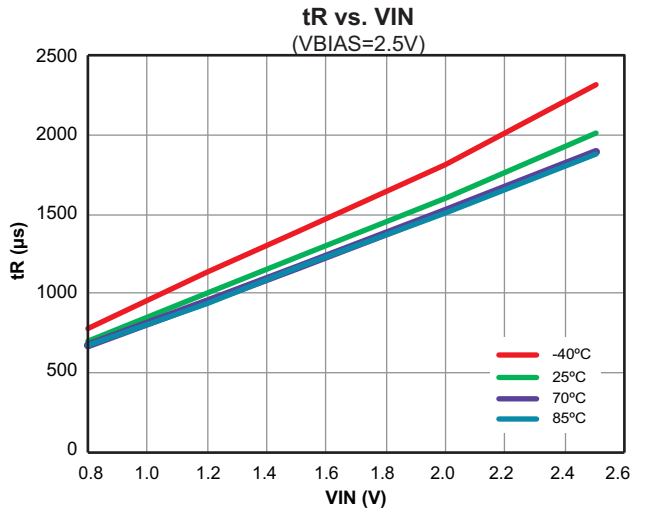
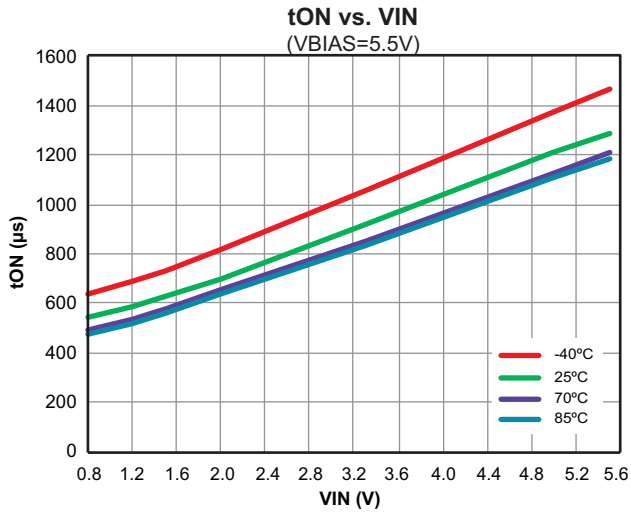
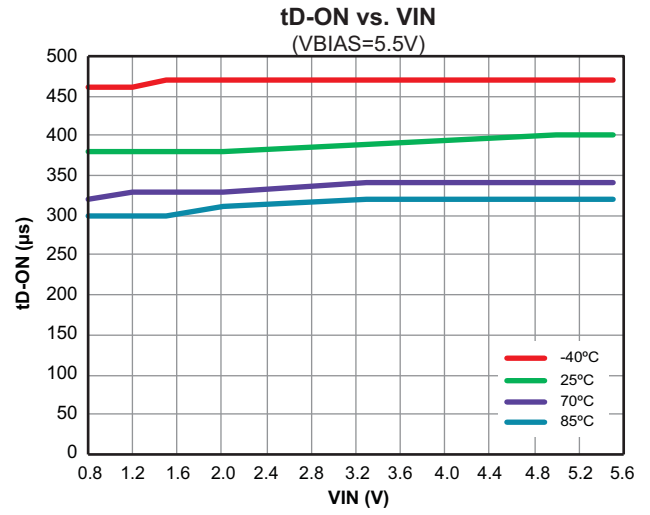
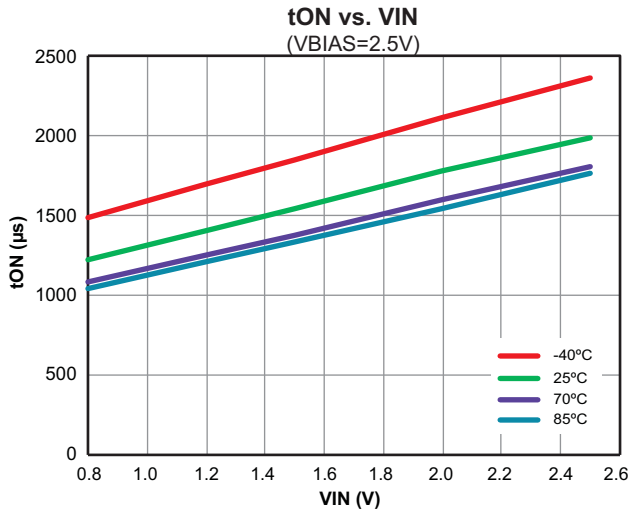

Typical Characteristics (Continued)

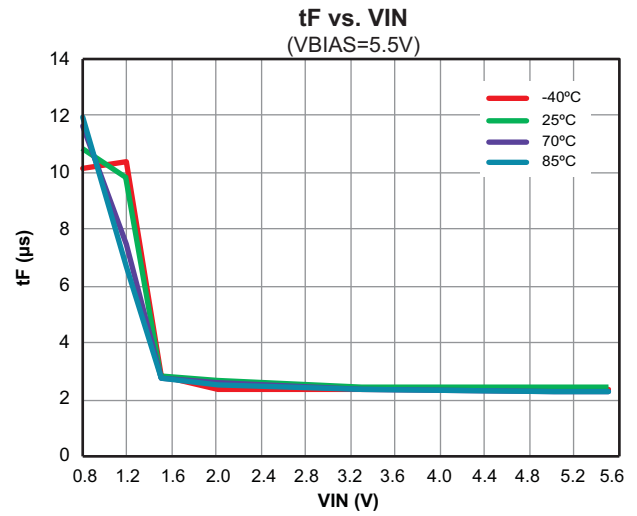
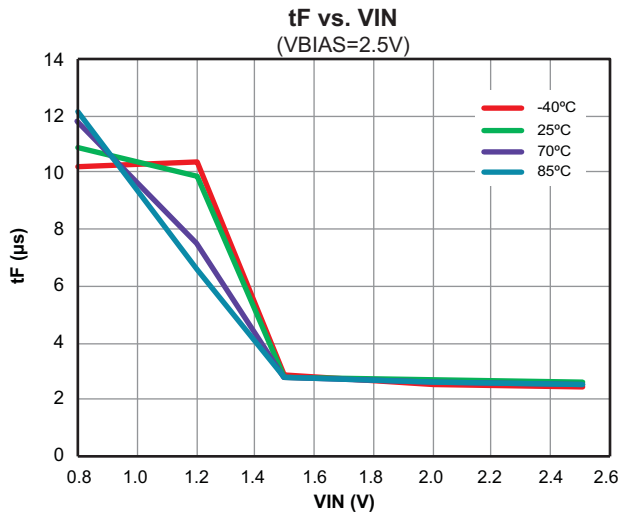
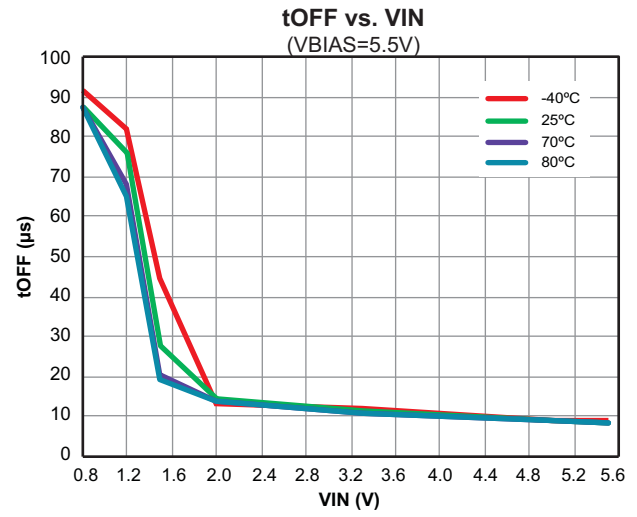
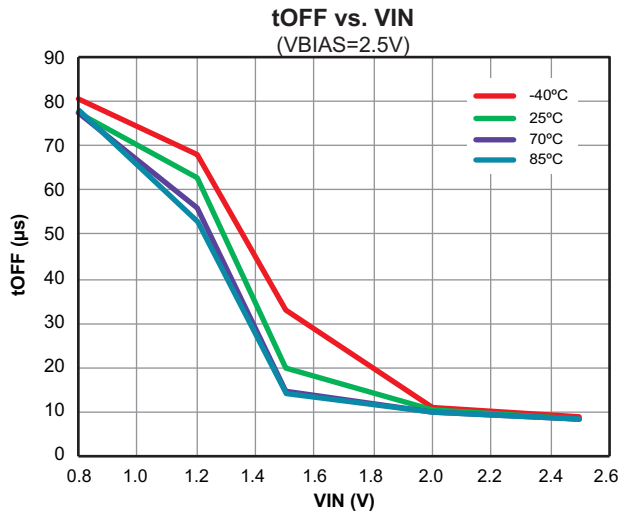



## Functional Characteristics

### Turn-ON & Turn-ON Rise Times

( $V_{IN}=5V$ ,  $V_{BIAS}=5V$ ,  $C_{IN}=1\mu F$ ,  $C_T=1nF$ ,  $C_L=0.1\mu F$ ,  $R_L=10\Omega$ )

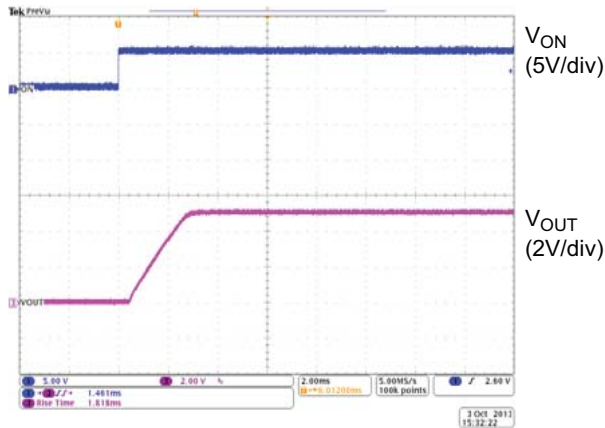

### Turn-ON & Turn-ON Rise Times

( $V_{IN}=0.8V$ ,  $V_{BIAS}=5V$ ,  $C_{IN}=1\mu F$ ,  $C_T=1nF$ ,  $C_L=0.1\mu F$ ,  $R_L=10\Omega$ )

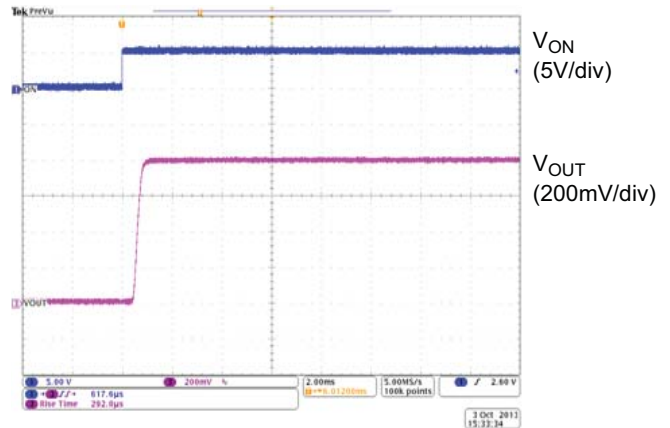

### Turn-ON & Turn-ON Rise Times

( $V_{IN}=2.5V$ ,  $V_{BIAS}=2.5V$ ,  $C_{IN}=1\mu F$ ,  $C_T=1nF$ ,  $C_L=0.1\mu F$ ,  $R_L=10\Omega$ )

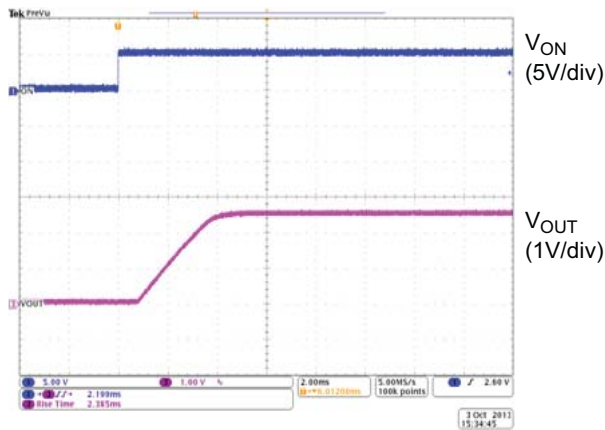

### Turn-ON & Turn-ON Rise Times

( $V_{IN}=0.8V$ ,  $V_{BIAS}=2.5V$ ,  $C_{IN}=1\mu F$ ,  $C_T=1nF$ ,  $C_L=0.1\mu F$ ,  $R_L=10\Omega$ )

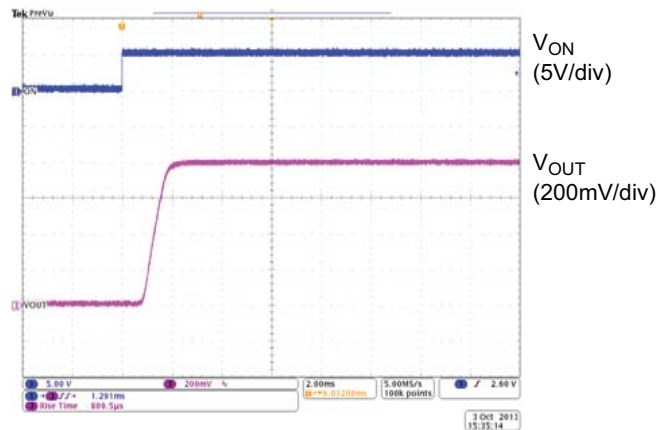

### Turn-OFF & Turn-OFF Fall Times

( $V_{IN}=5V$ ,  $V_{BIAS}=5V$ ,  $C_{IN}=1\mu F$ ,  $C_T=1nF$ ,  $C_L=0.1\mu F$ ,  $R_L=10\Omega$ )

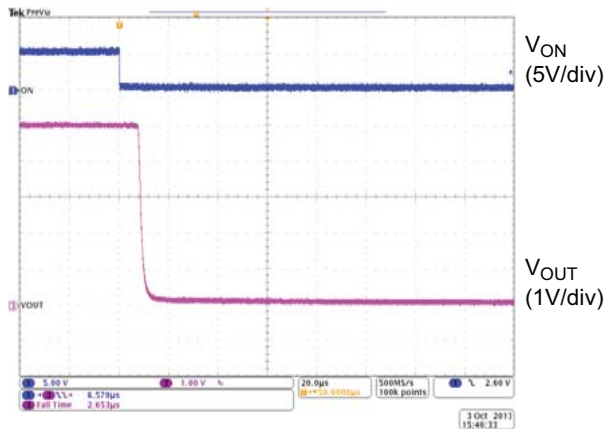

### Turn-OFF & Turn-OFF Fall Times

( $V_{IN}=0.8V$ ,  $V_{BIAS}=5V$ ,  $C_{IN}=1\mu F$ ,  $C_T=1nF$ ,  $C_L=0.1\mu F$ ,  $R_L=10\Omega$ )

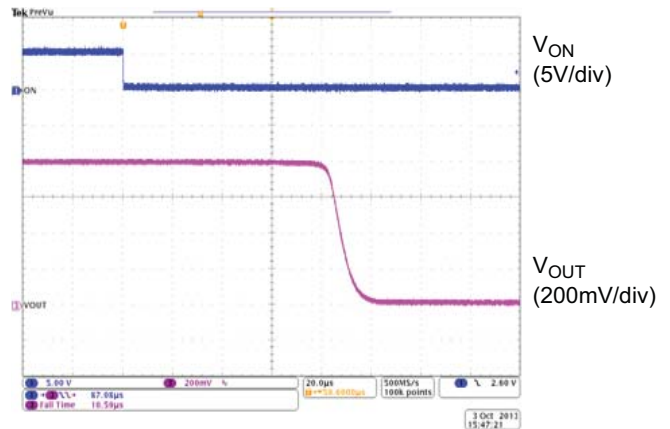

Functional Characteristics (Continued)

Turn-OFF Fall Times

( $V_{IN}=2.5V$ ,  $V_{BIAS}=2.5V$ ,  $C_{IN}=1\mu F$ ,  $C_T=1nF$ ,  $C_L=0.1\mu F$ ,  $R_L=10\Omega$ )

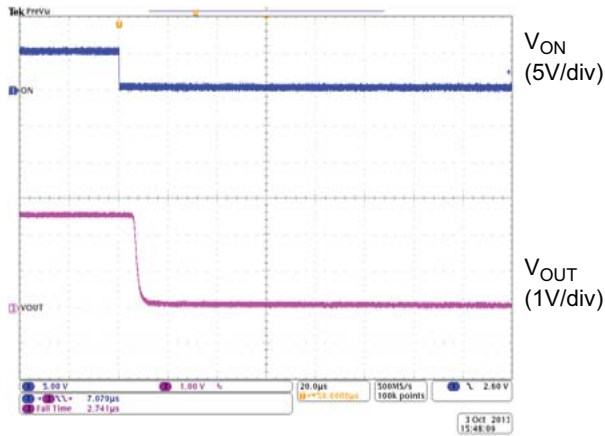

Turn-OFF Fall Times

( $V_{IN}=0.8V$ ,  $V_{BIAS}=2.5V$ ,  $C_{IN}=1\mu F$ ,  $C_T=1nF$ ,  $C_L=0.1\mu F$ ,  $R_L=10\Omega$ )

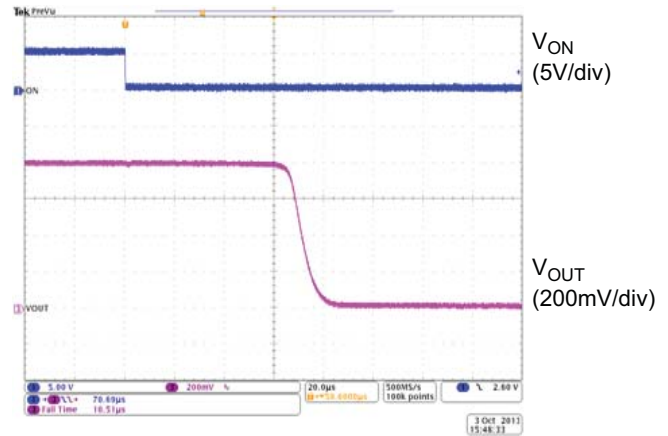

Turn-ON & Turn-OFF @  $I_{OUT} = 4A$

( $V_{IN}=5V$ ,  $V_{BIAS}=5V$ ,  $C_{IN}=4.7\mu F$ ,  $C_L=4.7\mu F$ )

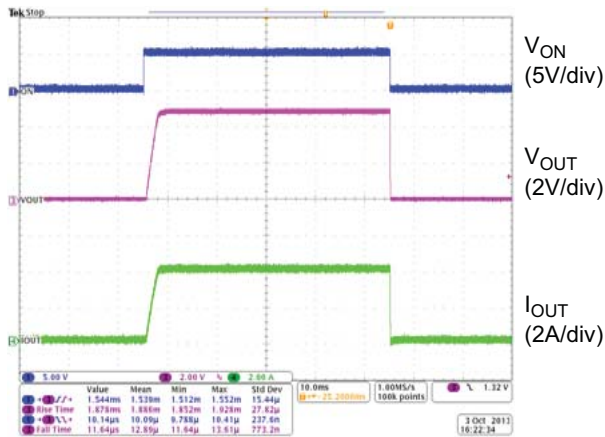

Turn-ON & Turn-OFF @  $I_{OUT} = 4A$

( $V_{IN}=2.5V$ ,  $V_{BIAS}=5V$ ,  $C_{IN}=4.7\mu F$ ,  $C_L=4.7\mu F$ )

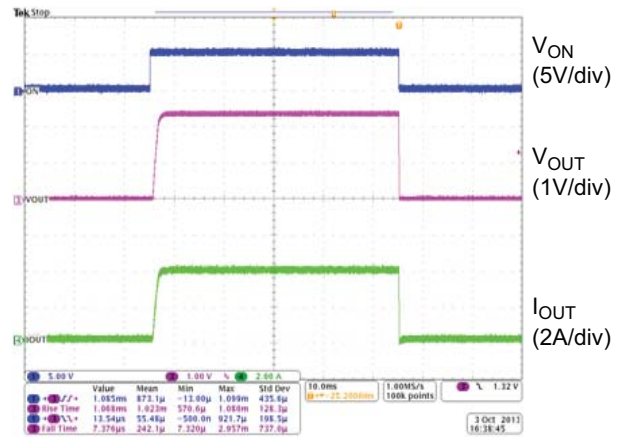

## Detailed Description

### ON/OFF Control

The AOZ1336DI is enabled when the ON pin is on active high with 1.2V or above voltage. The device is disabled when the ON pin voltage is 0.5V or lower. The EN input is compatible with both TTL and CMOS logic.

### VBIAS Voltage Range

For optimal on-resistance of load switch, make sure  $V_{IN} \leq V_{BIAS}$  and  $V_{BIAS}$  is within the voltage range from 2.5V to 5.5V. On-resistance of load switch will be higher if  $V_{IN} > V_{BIAS}$ . Resistance curves of a typical sample device at different  $V_{BIAS}$  and different  $V_{IN}$  are shown as below.

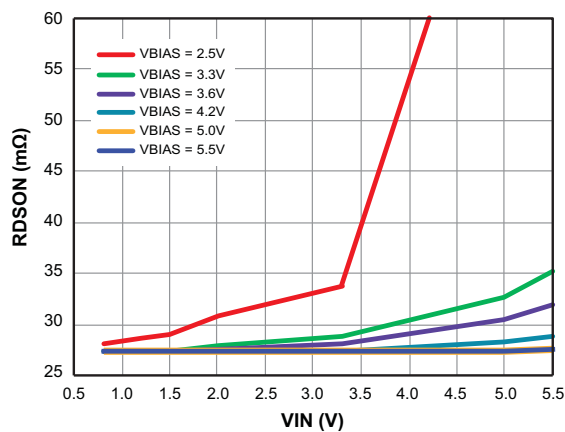

### Adjustable Rise Time

The slew rate of VOUT can be adjusted by external capacitors connected to the corresponding CT and GND pins. Multiply the input voltage and the slew rate to obtain the rise time. The table below shows rise times, which are measured on a typical device at  $V_{BIAS} = 5V$ .

| C <sub>T</sub><br>(pF) | Rise Time (μs) 10%~90%, C <sub>L</sub> =0.1μF, C <sub>IN</sub> 1μF, R <sub>L</sub> =10Ω (Typical values at 25°C, 25V X7R 10% Ceramic Cap) |       |      |      |      |       |      |
|------------------------|---|-------|------|------|------|-------|------|
|                        | V <sub>IN</sub> =5V   | 3.3V  | 1.8V | 1.5V | 1.2V | 1.05V | 0.8V |
| 0                      | 58  | 42    | 33   | 29   | 26   | 24    | 22   |
| 220                    | 372   | 226   | 130  | 104  | 91   | 81    | 66   |
| 470                    | 740   | 486   | 255  | 198  | 169  | 148   | 115  |
| 1000                   | 1607  | 1021  | 570  | 452  | 366  | 322   | 252  |
| 2200                   | 3532  | 2447  | 1351 | 1139 | 904  | 785   | 664  |
| 4700                   | 7275  | 4708  | 2802 | 2277 | 1920 | 1663  | 1286 |
| 10000                  | 16640   | 10700 | 6372 | 5176 | 4425 | 3868  | 3098 |

## Applications Information

The basic AOZ1336DI application circuit is shown in the first page. Component selection is explained below.

### Input Capacitor Selection

A capacitor of 1μF or higher value is recommended to be placed close to the IN pins of AOZ1336DI. This capacitor can reduce the voltage drop caused by the in-rush current during the turn-on transient of the load switch. A higher value capacitor can be used to further reduce the voltage drop during high-current application.

### Output Capacitor Selection

A capacitor of 0.1μF or higher value is recommended to be placed between the OUT pins and GND. The switching times are affected by the capacitance. A larger capacitor makes the initial turn-on transient smoother. This capacitor must be large enough to supply a fast transient load in order to prevent the output from dropping.

### Thermal Considerations

To ensure proper operation, the maximum junction temperature of the AOZ1336DI should not exceed 150°C. Several factors attribute to the junction temperature rise: load current, MOSFET on-resistance, junction-to-ambient thermal resistance, and ambient temperature. The maximum load current can be determined by:

$$I_{LOAD(MAX)} = \sqrt{\frac{T_{J(MAX)} - T_C}{\Theta_{JC} \times R_{DS(ON)}}$$

It is noted that the maximum continuous load current is 4A.

### Layout Guidelines

Good PCB is important for improving the thermal performance of AOZ1336DI. Place the input and output bypass capacitors close to the IN and OUT pins. The input and output PCB traces should be as wide as possible for the given PCB space. Use a ground plane to enhance the power dissipation capability of the device.

Package Dimensions, DFN2x2\_8L, EP1\_S

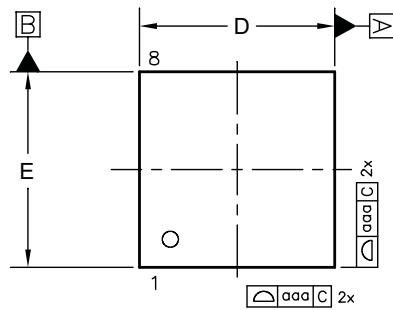

TOP VIEW

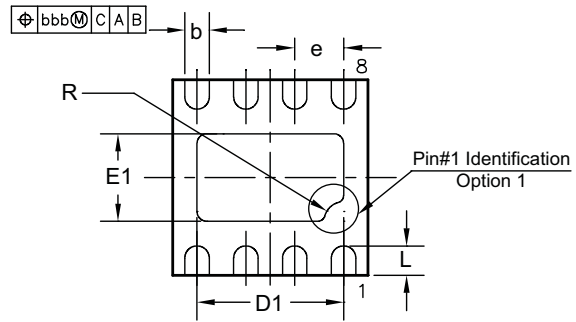

BOTTOM VIEW

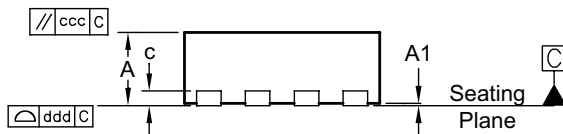

SIDE VIEW

RECOMMENDED LAND PATTERN

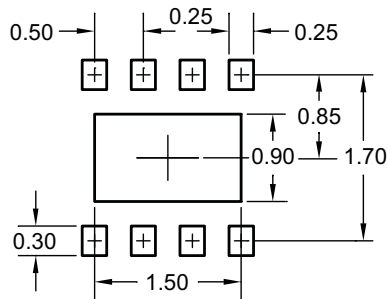

UNIT: mm

Dimensions in millimeters

| Symbols | Min.     | Nom. | Max. |
|---------|----------|------|------|
| A       | 0.70     | 0.75 | 0.80 |
| A1      | 0.00     | 0.02 | 0.05 |
| b       | 0.18     | 0.25 | 0.30 |
| c       | 0.20 REF |      |      |
| D       | 1.90     | 2.00 | 2.10 |
| D1      | 1.10     | 1.50 | 1.60 |
| E       | 1.90     | 2.00 | 2.10 |
| E1      | 0.50     | 0.90 | 1.00 |
| e       | 0.50 BSC |      |      |
| L       | 0.20     | 0.30 | 0.40 |
| R       | 0.20     |      |      |
| aaa     | 0.15     |      |      |
| bbb     | 0.10     |      |      |
| ccc     | 0.10     |      |      |
| ddd     | 0.08     |      |      |

Dimensions in inches

| Symbols | Min.      | Nom.  | Max.  |
|---------|-----------|-------|-------|
| A       | 0.028     | 0.030 | 0.031 |
| A1      | 0.000     | 0.001 | 0.002 |
| b       | 0.007     | 0.010 | 0.012 |
| c       | 0.008 REF |       |       |
| D       | 0.075     | 0.079 | 0.083 |
| D1      | 0.043     | 0.059 | 0.063 |
| E       | 0.075     | 0.079 | 0.083 |
| E1      | 0.020     | 0.035 | 0.039 |
| e       | 0.020 BSC |       |       |
| L       | 0.008     | 0.012 | 0.016 |
| R       | 0.008     |       |       |
| aaa     | 0.006     |       |       |
| bbb     | 0.004     |       |       |
| ccc     | 0.004     |       |       |
| ddd     | 0.003     |       |       |

Notes:

1. Dimensions and tolerances conform to ASME Y14.5M-1994.
2. Controlling dimension is millimeter, converted inch dimensions are not necessarily exact.
3. Dimension b applied to metallized terminal and is measured between 0.10mm and 0.30mm from the terminal tip. If the terminal has the optional radius on the other end of the terminal, dimension b should not be measured in that radius area.
4. Coplanarity ddd applies to the terminals and all other bottom surface metallization.

Tape and Reel Dimensions, DFN2x2\_8L, EP1\_S

Carrier Tape

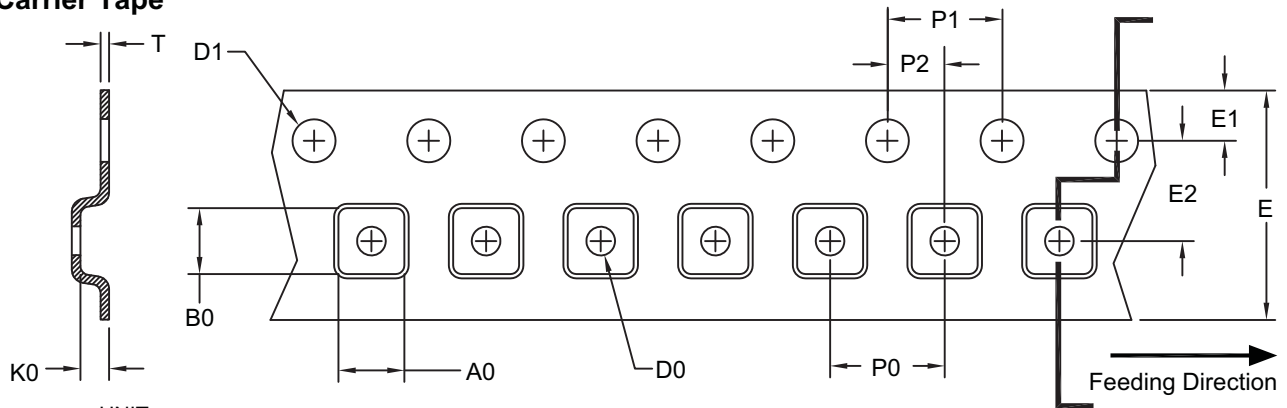

UNIT: mm

| Package | A0            | B0            | K0            | D0           | D1                 | E                   | E1            | E2            | P0            | P1            | P2            | T             |
|---------|---------------|---------------|---------------|--------------|--------------------|---------------------|---------------|---------------|---------------|---------------|---------------|---------------|
| DFN 2x2 | 2.30<br>±0.20 | 2.30<br>±0.20 | 1.00<br>±0.20 | 1.00<br>MIN. | 1.50<br>+0.10/-0.0 | 8.00<br>+0.30/-0.10 | 1.75<br>±0.10 | 3.50<br>±0.05 | 4.00<br>±0.20 | 4.00<br>±0.20 | 2.00<br>±0.05 | 0.30<br>±0.05 |

Reel

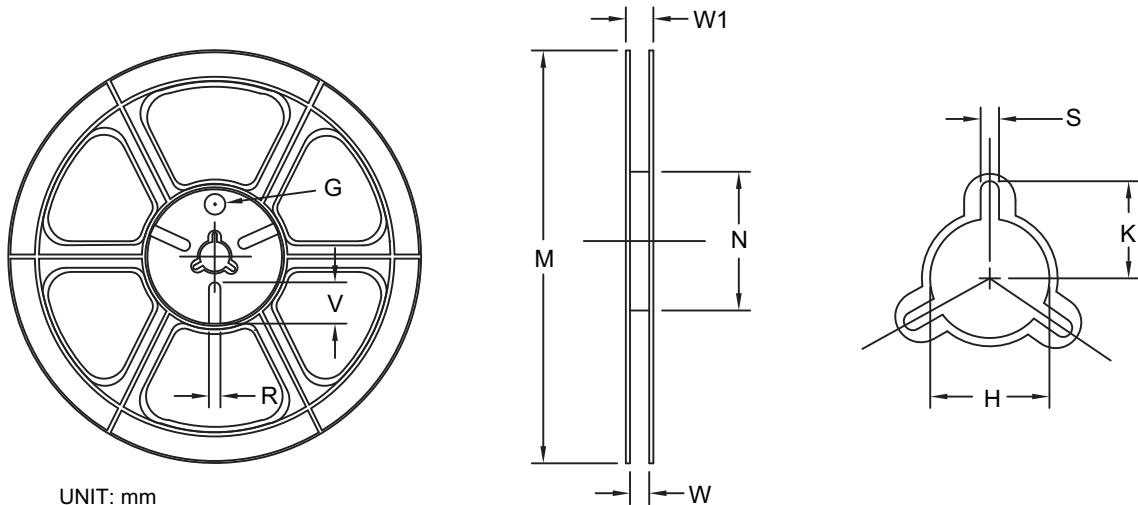

UNIT: mm

| Tape Size | Reel Size | M                | N               | W             | W1             | H                   | K              | S             | G     | R   | V   |
|-----------|-----------|------------------|-----------------|---------------|----------------|---------------------|----------------|---------------|-------|-----|-----|
| 8mm       | ø178      | ø178.00<br>±1.00 | ø70.50<br>±1.00 | 9.00<br>±0.50 | 11.80<br>±1.10 | ø13.00<br>+0.5/-0.2 | 10.25<br>±0.20 | 2.40<br>±0.10 | ø9.80 | N/A | N/A |

Leader / Trailer & Orientation

Unit Per Reel:  
3000pcs

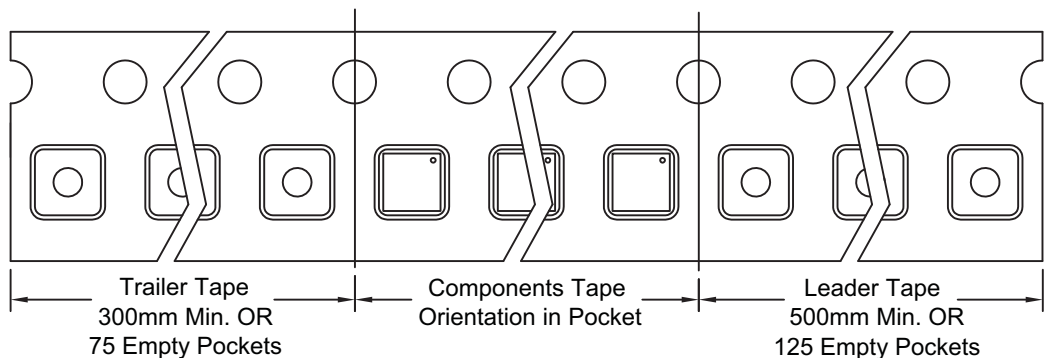

## Package Marking

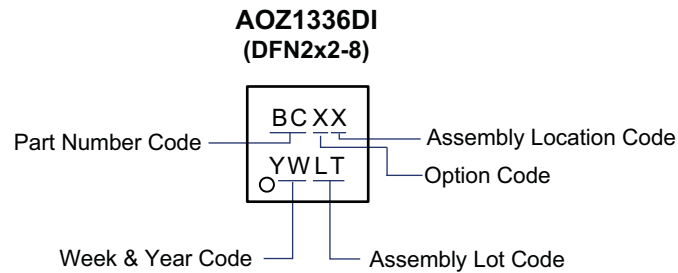

### LEGAL DISCLAIMER

Applications or uses as critical components in life support devices or systems are not authorized. AOS does not assume any liability arising out of such applications or uses of its products. AOS reserves the right to make changes to product specifications without notice. It is the responsibility of the customer to evaluate suitability of the product for their intended application. Customer shall comply with applicable legal requirements, including all applicable export control rules, regulations and limitations.

AOS' products are provided subject to AOS' terms and conditions of sale which are set forth at:  
[http://www.aosmd.com/terms\\_and\\_conditions\\_of\\_sale](http://www.aosmd.com/terms_and_conditions_of_sale)

### LIFE SUPPORT POLICY

ALPHA AND OMEGA SEMICONDUCTOR PRODUCTS ARE NOT AUTHORIZED FOR USE AS CRITICAL COMPONENTS IN LIFE SUPPORT DEVICES OR SYSTEMS.

As used herein:

- |   |   |
|---|---|
| <p>1. Life support devices or systems are devices or systems which, (a) are intended for surgical implant into the body or (b) support or sustain life, and (c) whose failure to perform when properly used in accordance with instructions for use provided in the labeling, can be reasonably expected to result in a significant injury of the user.</p> | <p>2. A critical component in any component of a life support, device, or system whose failure to perform can be reasonably expected to cause the failure of the life support device or system, or to affect its safety or effectiveness.</p> |
|---|---|