

DO-218 Package

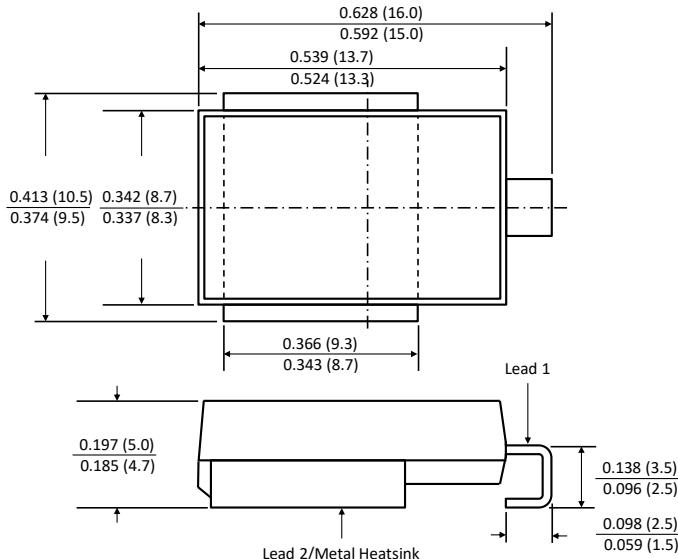

Dimension in inches and (millimeter)

PRIMARY CHARACTERISTICS	
VRWM	16V to 43V
VBR	17.8V to 52.8V
PPPM (10/1000us)	4600W
TJ max	175°C
Polarity	Uni-directional & Bi-directional
Package	DO-218

FEATURES

- Glass passivated junction technology
- Low forward voltage drop for Uni-directional polarity
- Fast response time: typical less than 1.0ps from 0 Volts to BV
- TJ = 175°C capability suitable for high reliability
- High surge capability
- Maximum peak power dissipation: 4600 Watts
- Meets ISO7637-2 & ISO16750-2 surge specification (varied by test condition)
- Halogen-Free
- RoHS compliant
- AEC-Q101 qualified



MECHANICAL DATA

Case: DO-218. Molded plastic over glass passivated junction Molding compound meets UL 94V-0 flammability rating

Terminal: Solderable per MIL-STD-750, Method 2026

Polarity: Heat sink is anode, Color band denoted positive end (cathode) except Bidirectional.

Typical Application

Use in sensitive electronics protection against voltage transients induced by inductive load switching and lighting. Especially for automotive load dump protection application.

Typical Application

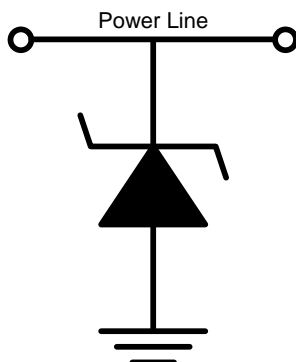

Functional Diagram

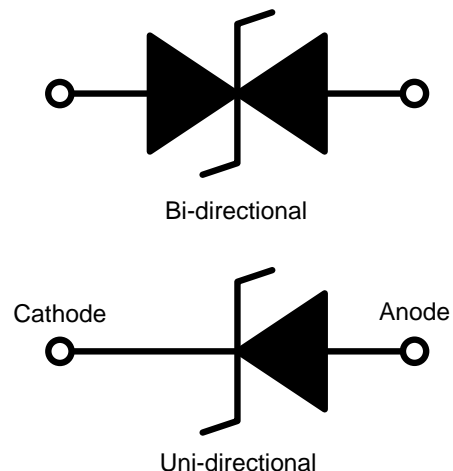

Ordering Information

Part Number	Quantity	Packing Option	Component Package	Packing Specification
ALD6SxxA	750	Tape & Reel - 24mm/13" tape	DO-218	EIA STD RS-481



AOS products are offered in packages with Pb-free plating and compliant to RoHS standards. Please visit <https://aosmd.com/sites/default/files/media/AOSGreenPolicy.pdf> for additional information.

MAXIMUM RATINGS (25°C ambient temperature unless otherwise specified)

Parameter	Symbol	Value	Unit
Peak Pulse Power Dissipation on 10/1000µs waveform ⁽¹⁾	PPPM	4600	Watts
Peak Pulse Power Dissipation on 10/10000µs waveform ⁽¹⁾	PPPM	3600	Watts
Peak Pulse Current of on 10/1000µs waveform	IPPM	See next table	Amps
Power dissipation on infinite heatsink (T _C = 25°C)	P _D	6	Watts
Peak Forward Surge Current, 8.3ms Single Half Sine-Wave, Superimposed on Rated Load. (JEDEC Method)	I _{FSM}	600	Amps
Operating junction and Storage Temperature Range	T _J T _{STG}	-55 to +175	°C

Note:

1. Non-repetitive current pulse above T_A = 25 °C

ELECTRICAL CHARACTERISTICS

PART NUMBER		REVERSE STAND-OFF VOLTAGE VRWM(V)	BREAKDOWN VOLTAGE VBR(V) @IT		TEST CURRENT I _r (mA)	MAXIMUM CLAMPING VOLTAGE @I _{pp} V _c (V)	MAXIMUM PEAK PULSE CURRENT I _{pp} (A)	MAXIMUM REVERSE LEAKAGE @ VRWM I _R (µA)
UNI- POLAR	BI-POLAR		MIN	MAX				
ALD6S16A	ALD6S16CA	16.0	17.80	19.70	5	26.0	177.0	10
ALD6S17A	ALD6S17CA	17.0	18.90	20.90	5	27.6	166.7	10
ALD6S18A	ALD6S18CA	18.0	20.00	22.10	5	29.2	157.6	10
ALD6S20A	ALD6S20CA	20.0	22.20	24.50	5	32.4	142.0	10
ALD6S22A	ALD6S22CA	22.0	24.40	26.90	5	35.5	129.6	10
ALD6S24A	ALD6S24CA	24.0	26.70	29.50	5	38.9	118.3	10
ALD6S26A	ALD6S26CA	26.0	28.90	31.90	5	42.1	109.3	10
ALD6S28A	ALD6S28CA	28.0	31.10	34.40	5	45.4	101.4	10
ALD6S30A	ALD6S30CA	30.0	33.30	36.80	5	48.4	95.2	10
ALD6S33A	ALD6S33CA	33.0	36.70	40.60	5	53.3	86.4	10
ALD6S36A	ALD6S36CA	36.0	40.00	44.20	5	58.1	79.2	10
ALD6S40A	ALD6S40CA	40.0	44.40	49.10	5	64.5	71.4	10
ALD6S43A	ALD6S43CA	43.0	47.80	52.80	5	69.4	66.3	10

Note:

For uni-directional part, the maximum V_F = 1.8 V at I_F = 100 A measured on 8.3ms single half sine-wave or equivalent square wave, duty cycle = 4 pulses per minute maximum

RATINGS AND CHARACTERISTICS CURVES ($T_A = 25^\circ\text{C}$ unless otherwise noted)

Power De-Rating Curve

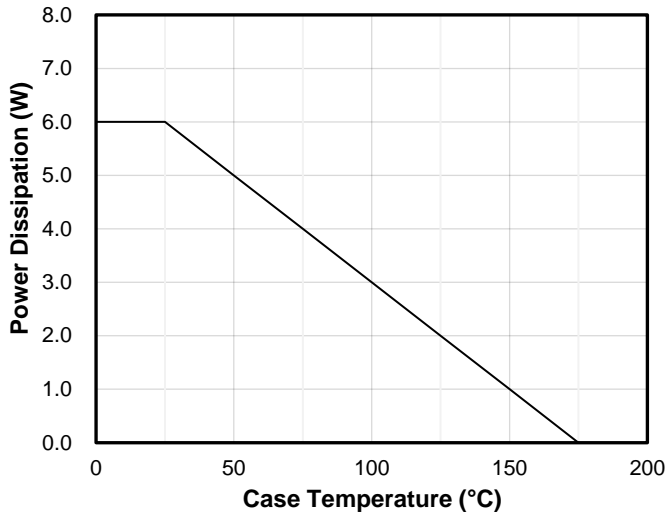

Load Dump Power Characteristics
(10mS Exponential waveform)

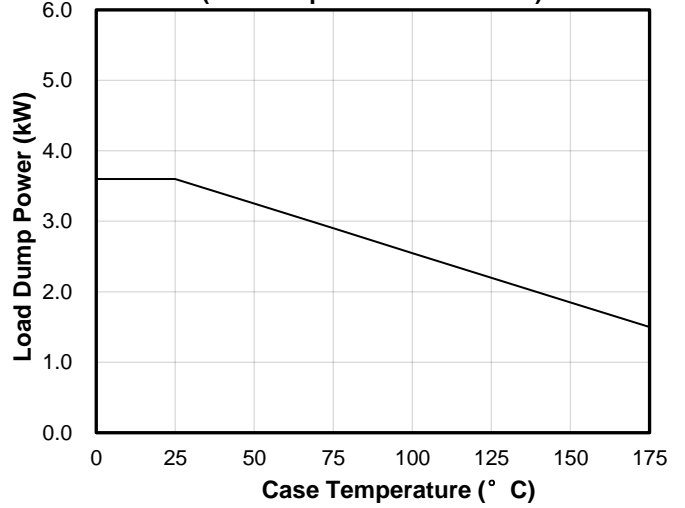

Pulse Waveform

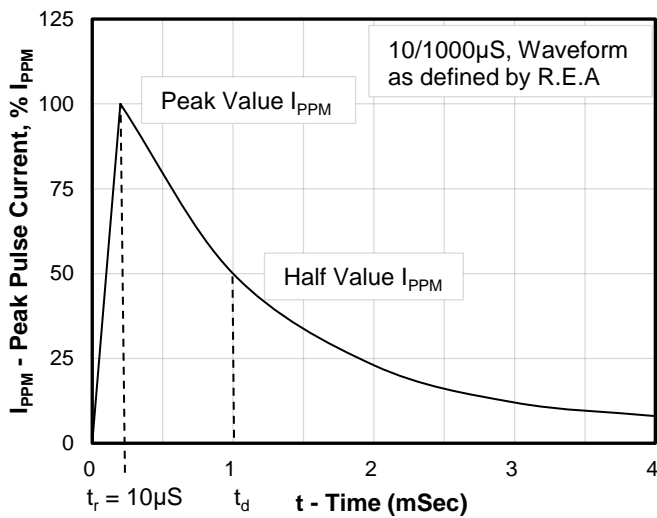

Reverse Power Capability

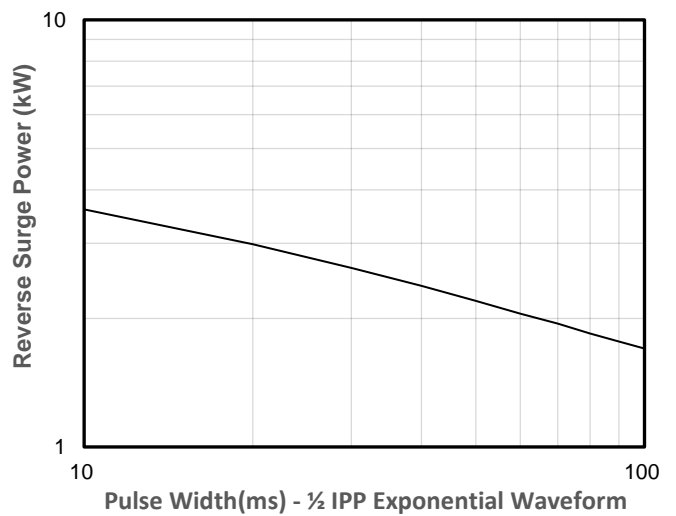

Typical Transient Thermal Impedance

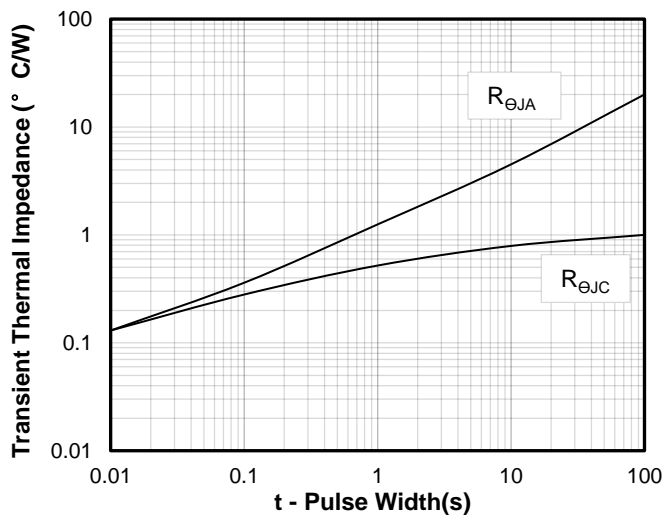

Soldering Parameters

Reflow Condition		Lead-free assembly
Pre Heat	-Temperature Min ($T_{s(min)}$)	150°C
	-Temperature Max ($T_{s(max)}$)	200°C
	-Time (min to max) (t_s)	60-120 seconds
Average ramp up rate (Liquidus Temp(T_L) to peak)		3°C/second max
$T_{s(max)}$ to T_L - Ramp-up Rate		3°C/second max
Reflow	-Temperature Min (T_L)	217°C
	Time (t_L) maintained above T_L	60-150 seconds
Peak temperature(T_P)		245 $\pm 0/-5$ °C
Time within 5°C of actual peak Temperature(t_p)		20-40 seconds
Ramp-down Rate		6°C/second max
Time 25°C to peak temperature(T_P)		8 minutes max

Soldering Profile

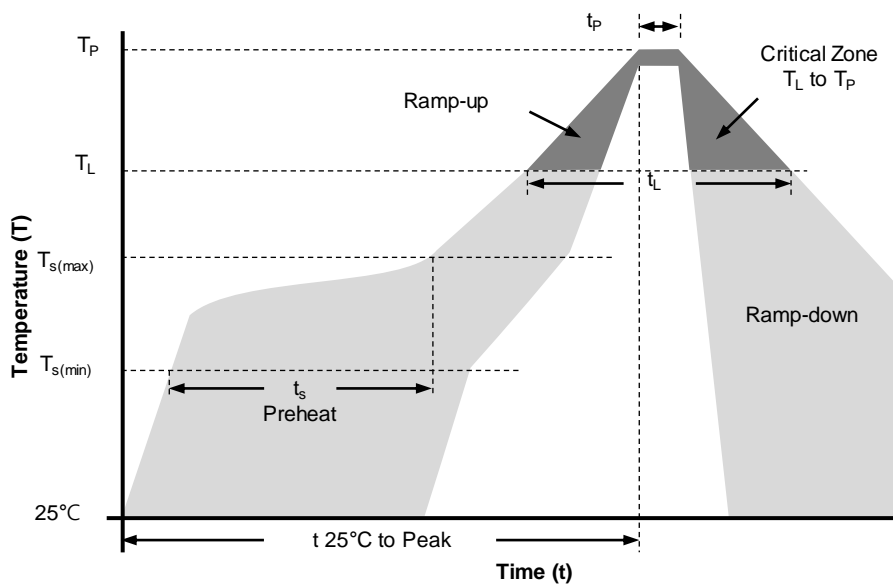

PART MARKING

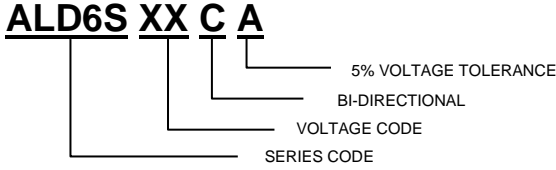
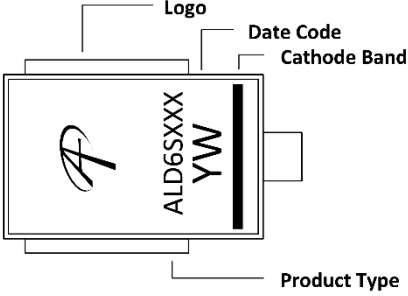
Part Number	Part Marking
 <p>ALD6S XX C A</p> <ul style="list-style-type: none"> ALD6S: SERIES CODE XX: VOLTAGE CODE C: BI-DIRECTIONAL A: 5% VOLTAGE TOLERANCE 	 <p>ALD6S series</p> <ul style="list-style-type: none"> Logo Date Code Cathode Band Product Type

LEGAL DISCLAIMER

Applications or uses as critical components in life support devices or systems are not authorized. Alpha and Omega Semiconductor does not assume any liability arising out of such applications or uses of its products. AOS reserves the right to make changes to product specifications without notice. It is the responsibility of the customer to evaluate suitability of the product for their intended application. Customer shall comply with applicable legal requirements, including all applicable export control rules, regulations and limitations.

AOS's products are provided subject to AOS's terms and conditions of sale which are set forth at: http://www.aosmd.com/terms_and_conditions_of_sale

LIFE SUPPORT POLICY

ALPHA AND OMEGA SEMICONDUCTOR PRODUCTS ARE NOT AUTHORIZED FOR USE AS CRITICAL COMPONENTS IN LIFE SUPPORT DEVICES OR SYSTEMS

As used herein:

1. Life support devices or systems are devices or systems which, (a) are intended for surgical implant into the body or (b) support or sustain life, and (c) whose failure to perform when properly used in accordance with instructions for use provided in the labeling, can be reasonably expected to result in a significant injury of the user.
2. A critical component in any component of a life support, device, or system whose failure to perform can be reasonably expected to cause the failure of the life support device or system, or to affect its safety or effectiveness.