



**General Description**

- Proprietary  $\alpha$ MOS5™ technology
- Low  $R_{DS(ON)}$
- Optimized switching parameters for better EMI performance
- Enhanced body diode for robustness and fast reverse recovery
- RoHS 2.0 and Halogen-Free Compliant

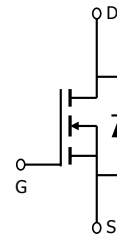
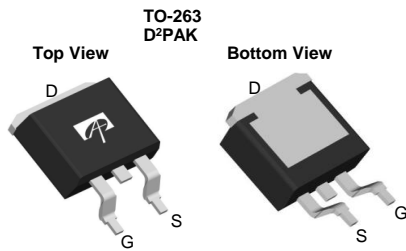
**Applications**

- PFC and PWM stages (LLC, PSFB, TTF) of Server, Telecom, Industrial, UPS, and Solar Inverters

**Product Summary**

$V_{DS} @ T_{j,max}$	700V
$I_{DM}$	140A
$R_{DS(ON),max}$	< 0.08 $\Omega$
$Q_{g,typ}$	70nC
$E_{oss} @ 400V$	9.1 $\mu$ J

100% UIS Tested  
100%  $R_g$  Tested



Orderable Part Number	Package Type	Form	Minimum Order Quantity
AOB080A60L	TO-263 Green	Tube	800

**Absolute Maximum Ratings  $T_A=25^\circ\text{C}$  unless otherwise noted**

Parameter	Symbol	Maximum	Units
Drain-Source Voltage	$V_{DS}$	600	V
Gate-Source Voltage	$V_{GS}$	$\pm 20$	V
Continuous Drain Current	$I_D$	$T_C=25^\circ\text{C}$	35
		$T_C=100^\circ\text{C}$	22
Pulsed Drain Current <sup>C</sup>	$I_{DM}$	140	A
Avalanche Current <sup>C</sup>	$I_{AR}$	11	A
Repetitive avalanche energy <sup>C</sup>	$E_{AR}$	60	mJ
Single pulsed avalanche energy <sup>G</sup>	$E_{AS}$	690	mJ
MOSFET dv/dt ruggedness	dv/dt	100	V/ns
Peak diode recovery dv/dt		20	
Power Dissipation <sup>B</sup>	$P_D$	$T_C=25^\circ\text{C}$	260
		Derate above 25 $^\circ\text{C}$	2.1
Junction and Storage Temperature Range	$T_J, T_{STG}$	-55 to 150	$^\circ\text{C}$
Maximum lead temperature for soldering purpose, 1/8" from case for 5 seconds	$T_L$	300	$^\circ\text{C}$

**Thermal Characteristics**

Parameter	Symbol	Maximum	Units
Maximum Junction-to-Ambient <sup>A,D</sup>	$R_{\theta JA}$	65	$^\circ\text{C/W}$
Maximum Case-to-sink <sup>A</sup>	$R_{\theta CS}$	0.5	$^\circ\text{C/W}$
Maximum Junction-to-Case	$R_{\theta JC}$	0.48	$^\circ\text{C/W}$

**Electrical Characteristics (T<sub>J</sub>=25°C unless otherwise noted)**

Symbol	Parameter	Conditions	Min	Typ	Max	Units	
<b>STATIC PARAMETERS</b>							
BV <sub>DSS</sub>	Drain-Source Breakdown Voltage	I <sub>D</sub> =250μA, V <sub>GS</sub> =0V, T <sub>J</sub> =25°C	600			V	
		I <sub>D</sub> =1mA, V <sub>GS</sub> =0V, T <sub>J</sub> =150°C		700			
BV <sub>DSS</sub> /ΔT <sub>J</sub>	Breakdown Voltage Temperature Coefficient	I <sub>D</sub> =1mA, V <sub>GS</sub> =0V		0.51		V/°C	
I <sub>DSS</sub>	Zero Gate Voltage Drain Current	V <sub>DS</sub> =600V, V <sub>GS</sub> =0V			1	μA	
		V <sub>DS</sub> =480V, T <sub>J</sub> =125°C		3.2			
I <sub>GSS</sub>	Gate-Body leakage current	V <sub>DS</sub> =0V, V <sub>GS</sub> =±20V			±100	nA	
V <sub>GS(th)</sub>	Gate Threshold Voltage	V <sub>DS</sub> =5V, I <sub>D</sub> =250μA	3	3.6	4.2	V	
R <sub>DS(ON)</sub>	Static Drain-Source On-Resistance	V <sub>GS</sub> =10V, I <sub>D</sub> =20A		0.071	0.08	Ω	
g <sub>FS</sub>	Forward Transconductance	V <sub>DS</sub> =10V, I <sub>D</sub> =20A		39		S	
V <sub>SD</sub>	Diode Forward Voltage	I <sub>S</sub> =20A, V <sub>GS</sub> =0V		0.85	1.2	V	
I <sub>S</sub>	Maximum Body-Diode Continuous Current				35	A	
I <sub>SM</sub>	Maximum Body-Diode Pulsed Current <sup>C</sup>				140	A	
<b>DYNAMIC PARAMETERS</b>							
C <sub>iss</sub>	Input Capacitance	V <sub>GS</sub> =0V, V <sub>DS</sub> =100V, f=1MHz		3960		pF	
C <sub>oss</sub>	Output Capacitance				116		pF
C <sub>o(er)</sub>	Effective output capacitance, energy related <sup>H</sup>	V <sub>GS</sub> =0V, V <sub>DS</sub> =0 to 480V, f=1MHz		104		pF	
C <sub>o(tr)</sub>	Effective output capacitance, time related <sup>I</sup>				470		pF
C <sub>rss</sub>	Reverse Transfer Capacitance	V <sub>GS</sub> =0V, V <sub>DS</sub> =100V, f=1MHz		0.9		pF	
R <sub>g</sub>	Gate resistance	f=1MHz		2.1		Ω	
<b>SWITCHING PARAMETERS</b>							
Q <sub>g</sub>	Total Gate Charge	V <sub>GS</sub> =10V, V <sub>DS</sub> =480V, I <sub>D</sub> =20A		70		nC	
Q <sub>gs</sub>	Gate Source Charge				18		nC
Q <sub>gd</sub>	Gate Drain Charge				20		nC
t <sub>D(on)</sub>	Turn-On DelayTime	V <sub>GS</sub> =10V, V <sub>DS</sub> =400V, I <sub>D</sub> =20A, R <sub>G</sub> =5Ω		32		ns	
t <sub>r</sub>	Turn-On Rise Time				34		ns
t <sub>D(off)</sub>	Turn-Off DelayTime				88		ns
t <sub>f</sub>	Turn-Off Fall Time				25		ns
t <sub>rr</sub>	Body Diode Reverse Recovery Time				450		ns
I <sub>rm</sub>	Peak Reverse Recovery Current	I <sub>F</sub> =20A, dI/dt=100A/μs, V <sub>DS</sub> =400V		35		A	
Q <sub>rr</sub>	Body Diode Reverse Recovery Charge			10.6		μC	

A. The value of R<sub>θJA</sub> is measured with the device in a still air environment with T<sub>A</sub>=25° C.

B. The power dissipation P<sub>D</sub> is based on T<sub>J(MAX)</sub>=150° C, using junction-to-case thermal resistance, and is more useful in setting the upper dissipation limit for cases where additional heatsinking is used.

C. Repetitive rating, pulse width limited by junction temperature T<sub>J(MAX)</sub>=150° C, Ratings are based on low frequency and duty cycles to keep initial T<sub>J</sub>=25° C.

D. The R<sub>θJA</sub> is the sum of the thermal impedance from junction to case R<sub>θJC</sub> and case to ambient.

E. The static characteristics in Figures 1 to 6 are obtained using <300μs pulses, duty cycle 0.5% max.

F. These curves are based on the junction-to-case thermal impedance which is measured with the device mounted to a large heatsink, assuming a maximum junction temperature of T<sub>J(MAX)</sub>=150° C. The SOA curve provides a single pulse rating.

G. L=60mH, I<sub>AS</sub>=4.8 A, R<sub>G</sub>=25Ω, Starting T<sub>J</sub>=25° C.

H. C<sub>o(er)</sub> is a fixed capacitance that gives the same stored energy as C<sub>oss</sub> while V<sub>DS</sub> is rising from 0 to 80% V<sub>(BR)DSS</sub>.

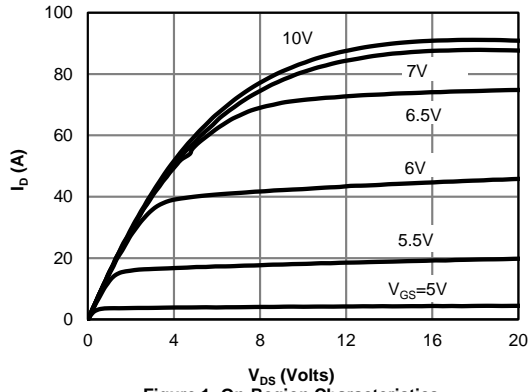
I. C<sub>o(tr)</sub> is a fixed capacitance that gives the same charging time as C<sub>oss</sub> while V<sub>DS</sub> is rising from 0 to 80% V<sub>(BR)DSS</sub>.

APPLICATIONS OR USES AS CRITICAL COMPONENTS IN LIFE SUPPORT DEVICES OR SYSTEMS ARE NOT AUTHORIZED. AOS DOES NOT ASSUME ANY LIABILITY ARISING OUT OF SUCH APPLICATIONS OR USES OF ITS PRODUCTS. AOS RESERVES THE RIGHT TO MAKE CHANGES TO PRODUCT SPECIFICATIONS WITHOUT NOTICE. IT IS THE RESPONSIBILITY OF THE CUSTOMER TO EVALUATE SUITABILITY OF THE PRODUCT FOR THEIR INTENDED APPLICATION. CUSTOMER SHALL COMPLY WITH APPLICABLE LEGAL REQUIREMENTS, INCLUDING ALL APPLICABLE EXPORT CONTROL RULES, REGULATIONS AND LIMITATIONS.

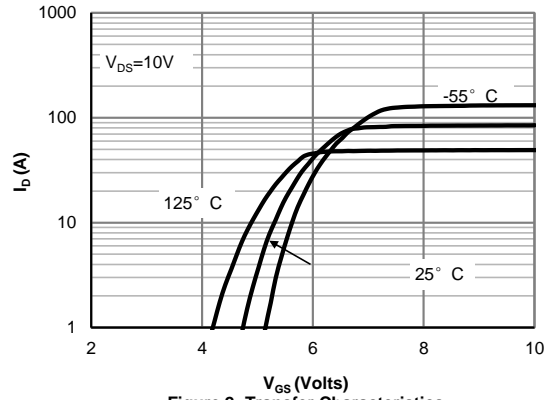
AOS' products are provided subject to AOS' terms and conditions of sale which are set forth at:

[http://www.aosmd.com/terms\\_and\\_conditions\\_of\\_sale](http://www.aosmd.com/terms_and_conditions_of_sale)

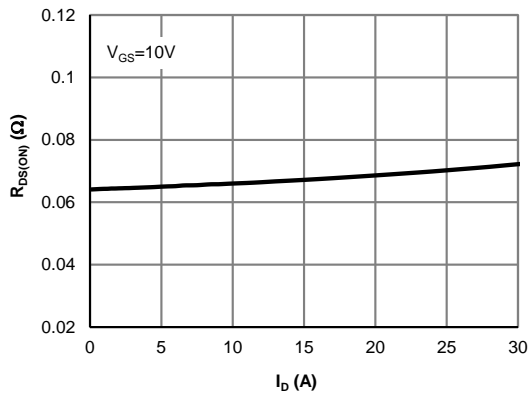
**TYPICAL ELECTRICAL AND THERMAL CHARACTERISTICS**



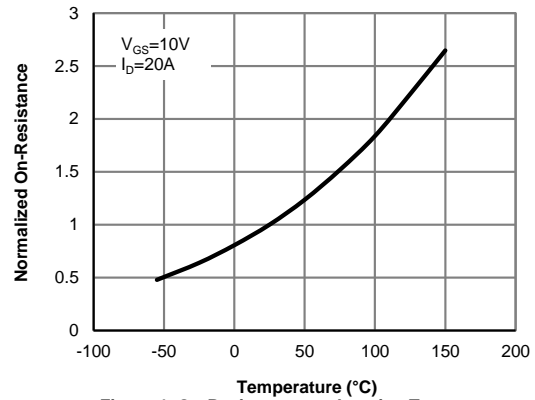
**Figure 1: On-Region Characteristics**



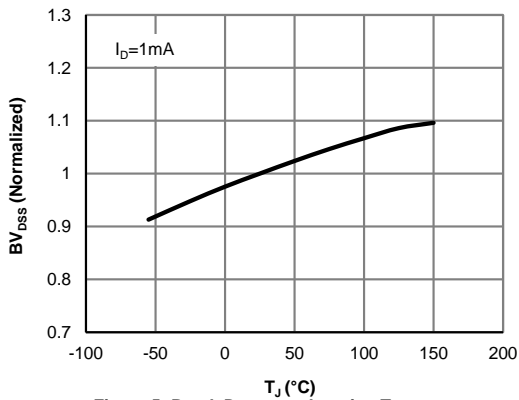
**Figure 2: Transfer Characteristics**



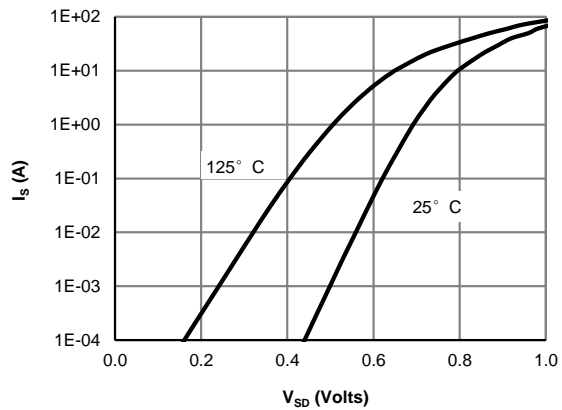
**Figure 3: On-Resistance vs. Drain Current and Gate Voltage**



**Figure 4: On-Resistance vs. Junction Temperature**

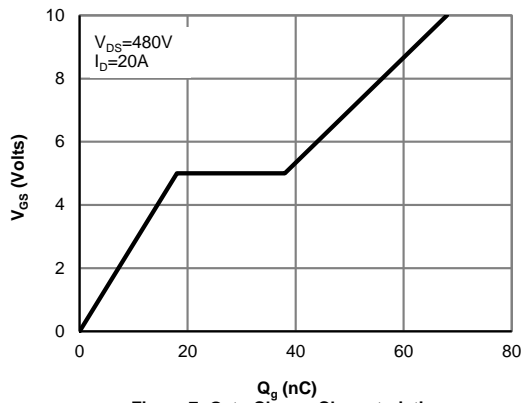


**Figure 5: Break Down vs. Junction Temperature**

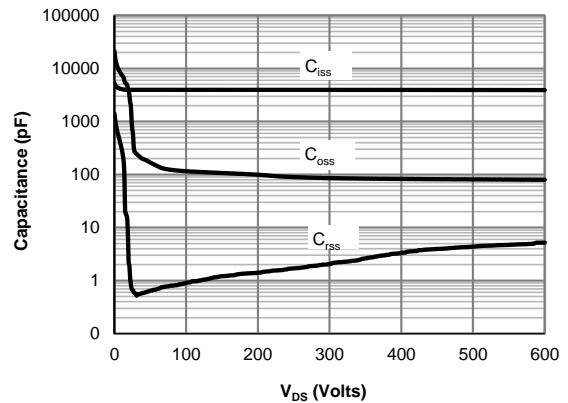


**Figure 6: Body-Diode Characteristics**

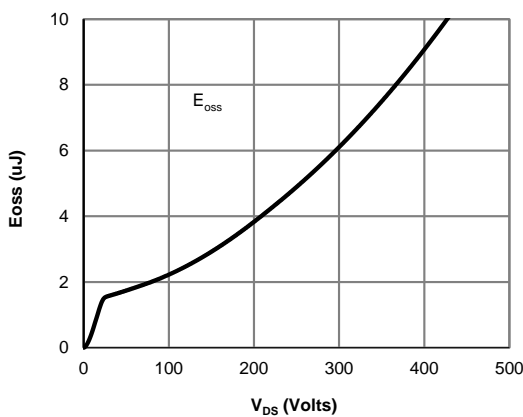
**TYPICAL ELECTRICAL AND THERMAL CHARACTERISTICS**



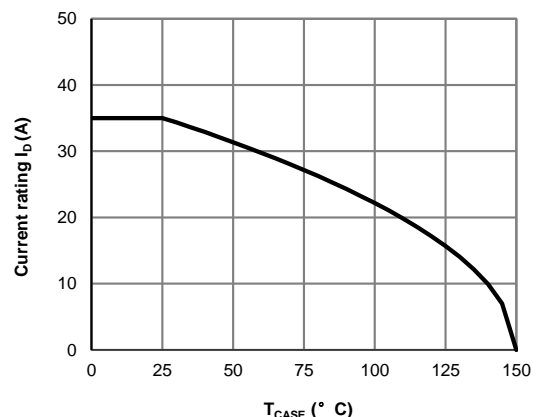
**Figure 7: Gate-Charge Characteristics**



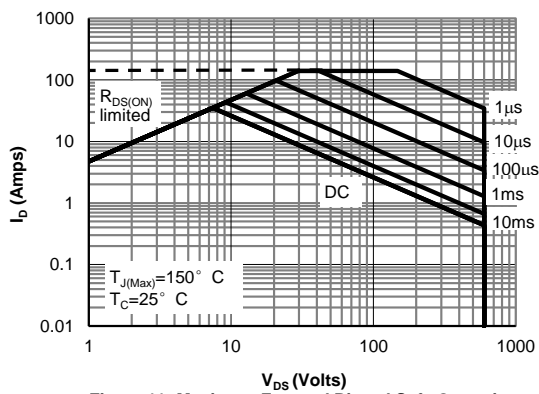
**Figure 8: Capacitance Characteristics**



**Figure 9: Coss stored Energy**

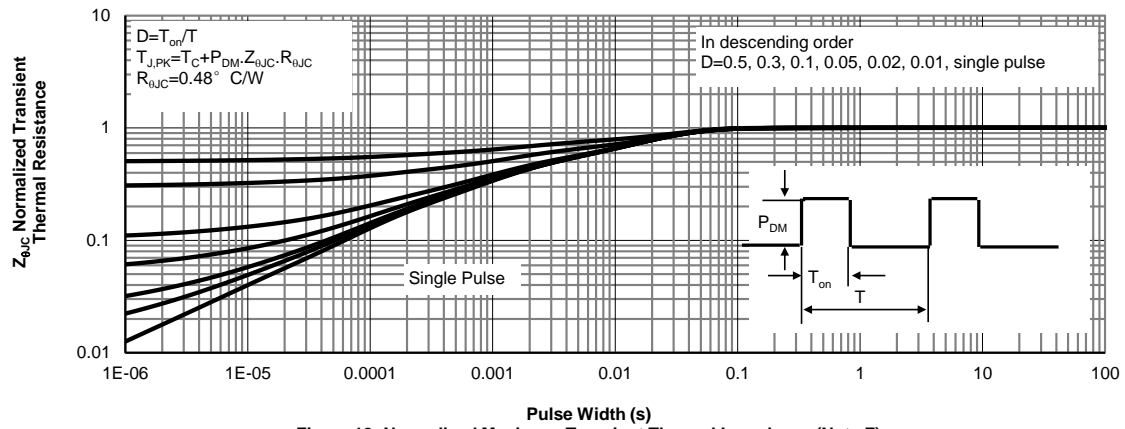


**Figure 10: Current De-rating (Note F)**



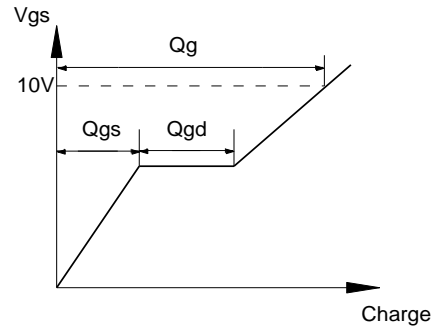
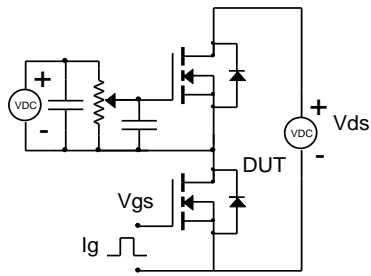
**Figure 11: Maximum Forward Biased Safe Operating Area (Note F)**

**TYPICAL ELECTRICAL AND THERMAL CHARACTERISTICS**

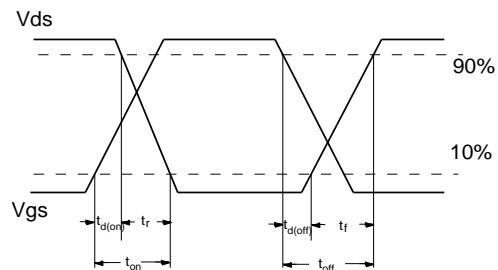
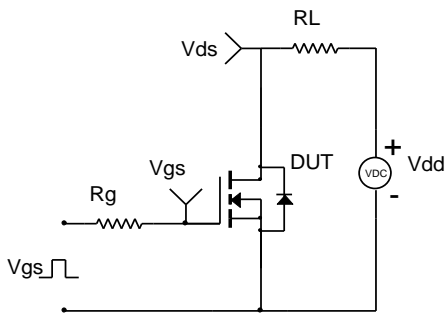


**Figure 12: Normalized Maximum Transient Thermal Impedance (Note F)**

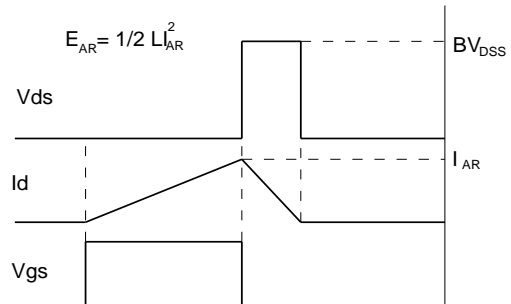
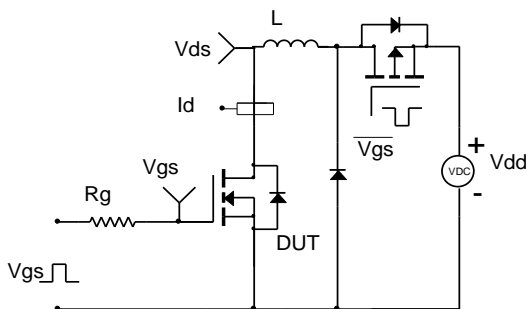
**Gate Charge Test Circuit & Waveform**



**Resistive Switching Test Circuit & Waveforms**



**Unclamped Inductive Switching (UIS) Test Circuit & Waveforms**



**Diode Recovery Test Circuit & Waveforms**

