



**General Description**

- Trench Power MOSFET technology
- Ultra low  $R_{SS(ON)}$
- With ESD protection to improve battery performance and safety
- Common drain configuration for design simplicity
- RoHS and Halogen-Free Compliant

**Applications**

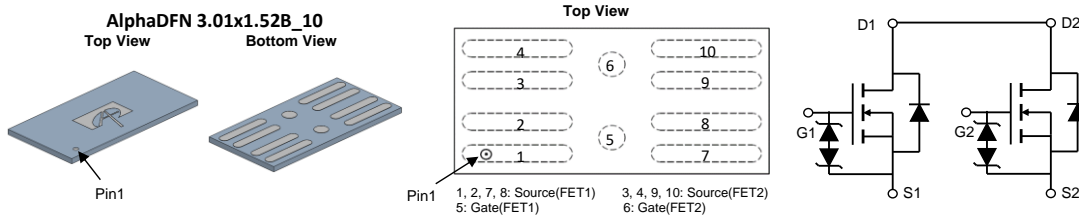
- Battery protection switch
- Mobile device battery charging and discharging

**Product Summary**

$V_{SS}$	12V
$R_{SS(ON)}$ (at $V_{GS}=4.5V$ )	< 3.8m $\Omega$
$R_{SS(ON)}$ (at $V_{GS}=3.8V$ )	< 4m $\Omega$
$R_{SS(ON)}$ (at $V_{GS}=3.1V$ )	< 4.6m $\Omega$
$R_{SS(ON)}$ (at $V_{GS}=2.5V$ )	< 5.6m $\Omega$

**Typical ESD protection**

HBM Class 2



Orderable Part Number	Package Type	Form	Minimum Order Quantity
AOC3870C	AlphaDFN 3.01x1.52B_10	Tape & Reel	8000

**Absolute Maximum Ratings  $T_A=25^\circ C$  unless otherwise noted**

Parameter	Symbol	Rating	Units
Source-Source Voltage	$V_{SS}$	12	V
Gate-Source Voltage	$V_{GS}$	$\pm 8$	V
Source Current(DC) <sup>Note1</sup>	$I_S$	25	A
Source Current(Pulse) <sup>Note2</sup>	$I_{SM}$	140	
Power Dissipation <sup>Note1</sup>	$P_D$	3.1	W
Junction and Storage Temperature Range	$T_J, T_{STG}$	-55 to 150	$^\circ C$

**Thermal Characteristics**

Parameter	Symbol	Typical	Units
Maximum Junction-to-Ambient $t \leq 10s$	$R_{\theta JA}$	30	$^\circ C/W$
Maximum Junction-to-Ambient Steady-State		40	$^\circ C/W$

**Note 1.**  $I_S$  rated value is based on bare silicon.Mounted on 70mmx70mm FR-4 board.

**Note 2.** PW <10  $\mu s$  pulses, duty cycle 1% max.

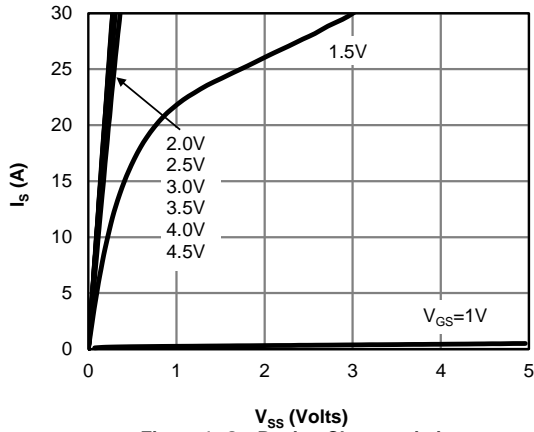
**Electrical Characteristics (T<sub>J</sub>=25°C unless otherwise noted)**

Symbol	Parameter	Conditions	Min	Typ	Max	Units
<b>STATIC PARAMETERS</b>						
BV <sub>SSS</sub>	Source-Source Breakdown Voltage	I <sub>S</sub> =250μA, V <sub>GS</sub> =0V Test Circuit 6	12			V
I <sub>SSS</sub>	Zero Gate Voltage Source Current	V <sub>SS</sub> =12V, V <sub>GS</sub> =0V Test Circuit 1			1	μA
		T <sub>J</sub> =55°C			5	
I <sub>GSS</sub>	Gate leakage current	V <sub>SS</sub> =0V, V <sub>GS</sub> =±8V Test Circuit 2			±10	μA
V <sub>GS(th)</sub>	Gate Threshold Voltage	V <sub>SS</sub> =V <sub>GS</sub> , I <sub>S</sub> =250μA Test Circuit 3	0.4	0.7	1.1	V
R <sub>SS(ON)</sub>	Static Source to Source On-Resistance	V <sub>GS</sub> =4.5V, I <sub>S</sub> =5A Test Circuit 4	2.1	2.95	3.8	mΩ
		T <sub>J</sub> =125°C	2.7	3.85	5.0	
		V <sub>GS</sub> =3.8V, I <sub>S</sub> =5A Test Circuit 4	2.3	3.10	4.0	mΩ
		V <sub>GS</sub> =3.1V, I <sub>S</sub> =5A Test Circuit 4	2.4	3.40	4.6	mΩ
		V <sub>GS</sub> =2.5V, I <sub>S</sub> =5A Test Circuit 4	2.8	3.90	5.6	mΩ
g <sub>FS</sub>	Forward Transconductance	V <sub>SS</sub> =5V, I <sub>S</sub> =5A Test Circuit 3		40		S
V <sub>FSS</sub>	Forward Source to Source Voltage	I <sub>S</sub> =1A, V <sub>GS</sub> =0V Test Circuit 5		0.6	1	V
<b>DYNAMIC PARAMETERS</b>						
R <sub>g</sub>	Gate resistance	f=1MHz		1.1		KΩ
<b>SWITCHING PARAMETERS</b>						
Q <sub>g</sub>	Total Gate Charge	V <sub>G1S1</sub> =4.5V, V <sub>SS</sub> =6V, I <sub>S</sub> =5A		32		nC
t <sub>D(on)</sub>	Turn-On DelayTime	V <sub>G1S1</sub> =4.5V, V <sub>SS</sub> =6V, R <sub>L</sub> =1.2Ω, R <sub>GEN</sub> =3Ω Test Circuit8		1.3		μs
t <sub>r</sub>	Turn-On Rise Time			3		μs
t <sub>D(off)</sub>	Turn-Off DelayTime			1.7		μs
t <sub>f</sub>	Turn-Off Fall Time			9		μs

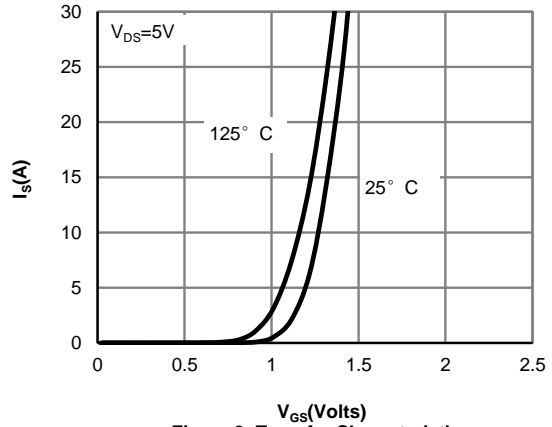
APPLICATIONS OR USES AS CRITICAL COMPONENTS IN LIFE SUPPORT DEVICES OR SYSTEMS ARE NOT AUTHORIZED. AOS DOES NOT ASSUME ANY LIABILITY ARISING OUT OF SUCH APPLICATIONS OR USES OF ITS PRODUCTS. AOS RESERVES THE RIGHT TO MAKE CHANGES TO PRODUCT SPECIFICATIONS WITHOUT NOTICE. IT IS THE RESPONSIBILITY OF THE CUSTOMER TO EVALUATE SUITABILITY OF THE PRODUCT FOR THEIR INTENDED APPLICATION. CUSTOMER SHALL COMPLY WITH APPLICABLE LEGAL REQUIREMENTS, INCLUDING ALL APPLICABLE EXPORT CONTROL RULES, REGULATIONS AND LIMITATIONS.

AOS' products are provided subject to AOS' terms and conditions of sale which are set forth at:  
[http://www.aosmd.com/terms\\_and\\_conditions\\_of\\_sale](http://www.aosmd.com/terms_and_conditions_of_sale)

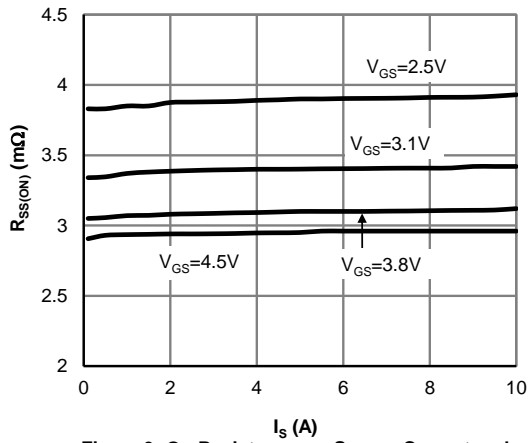
**TYPICAL ELECTRICAL AND THERMAL CHARACTERISTICS**



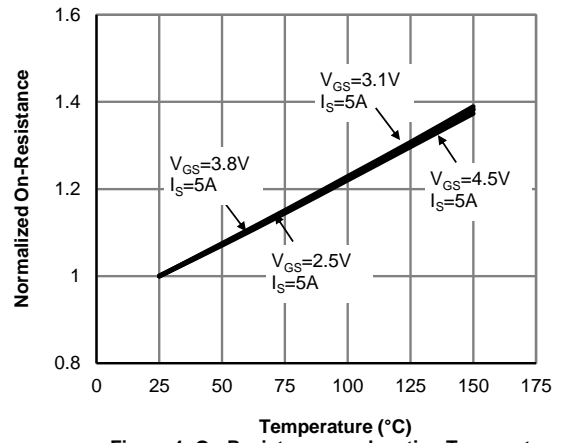
**Figure 1: On-Region Characteristics**



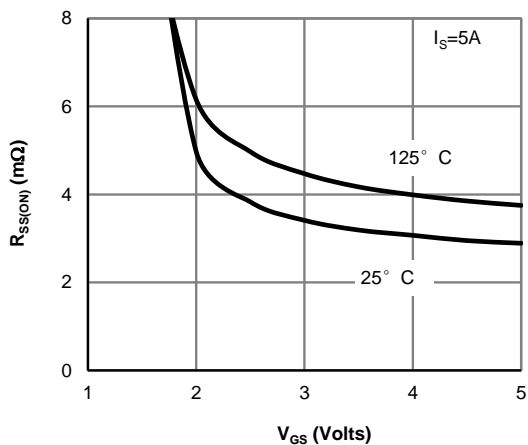
**Figure 2: Transfer Characteristics**



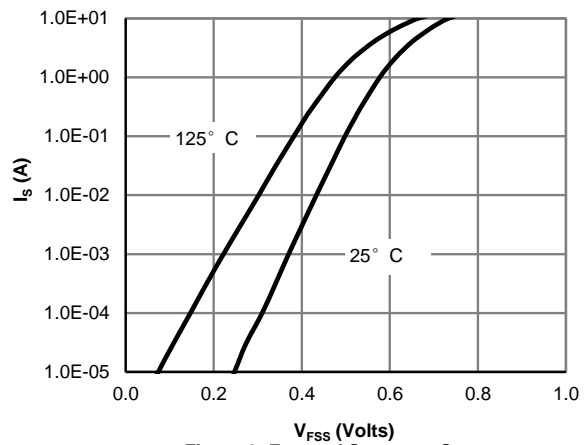
**Figure 3: On-Resistance vs. Source Current and Gate Voltage**



**Figure 4: On-Resistance vs. Junction Temperature**

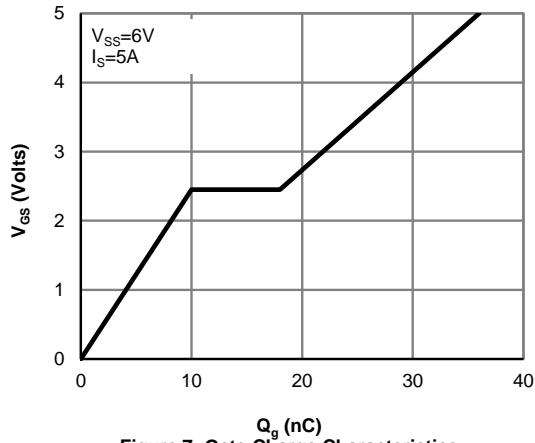


**Figure 5: On-Resistance vs. Gate-Source Voltage**

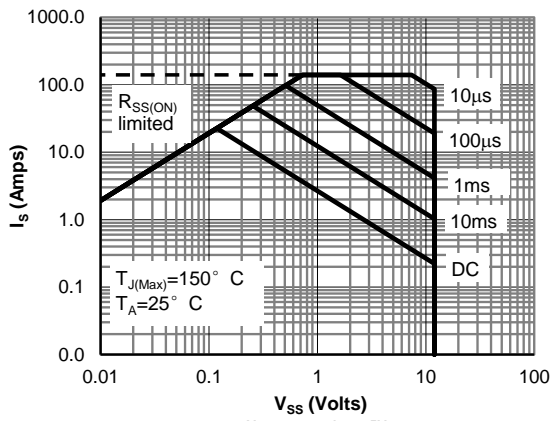


**Figure 6: Forward Source to Source Characteristics**

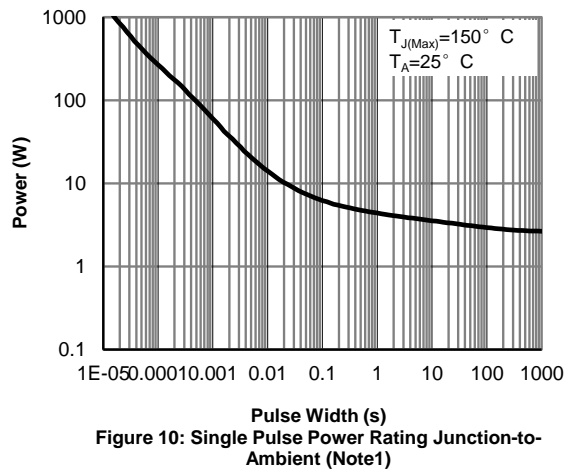
**TYPICAL ELECTRICAL AND THERMAL CHARACTERISTICS**



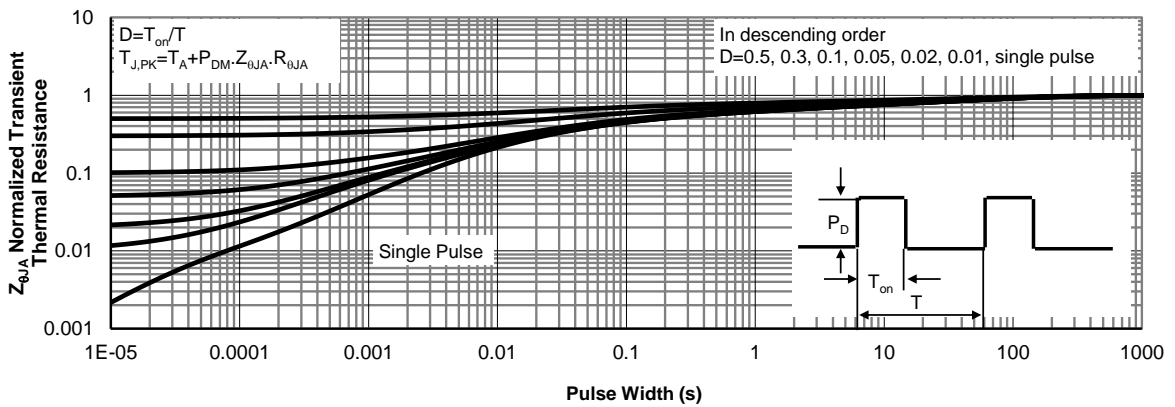
**Figure 7: Gate-Charge Characteristics**



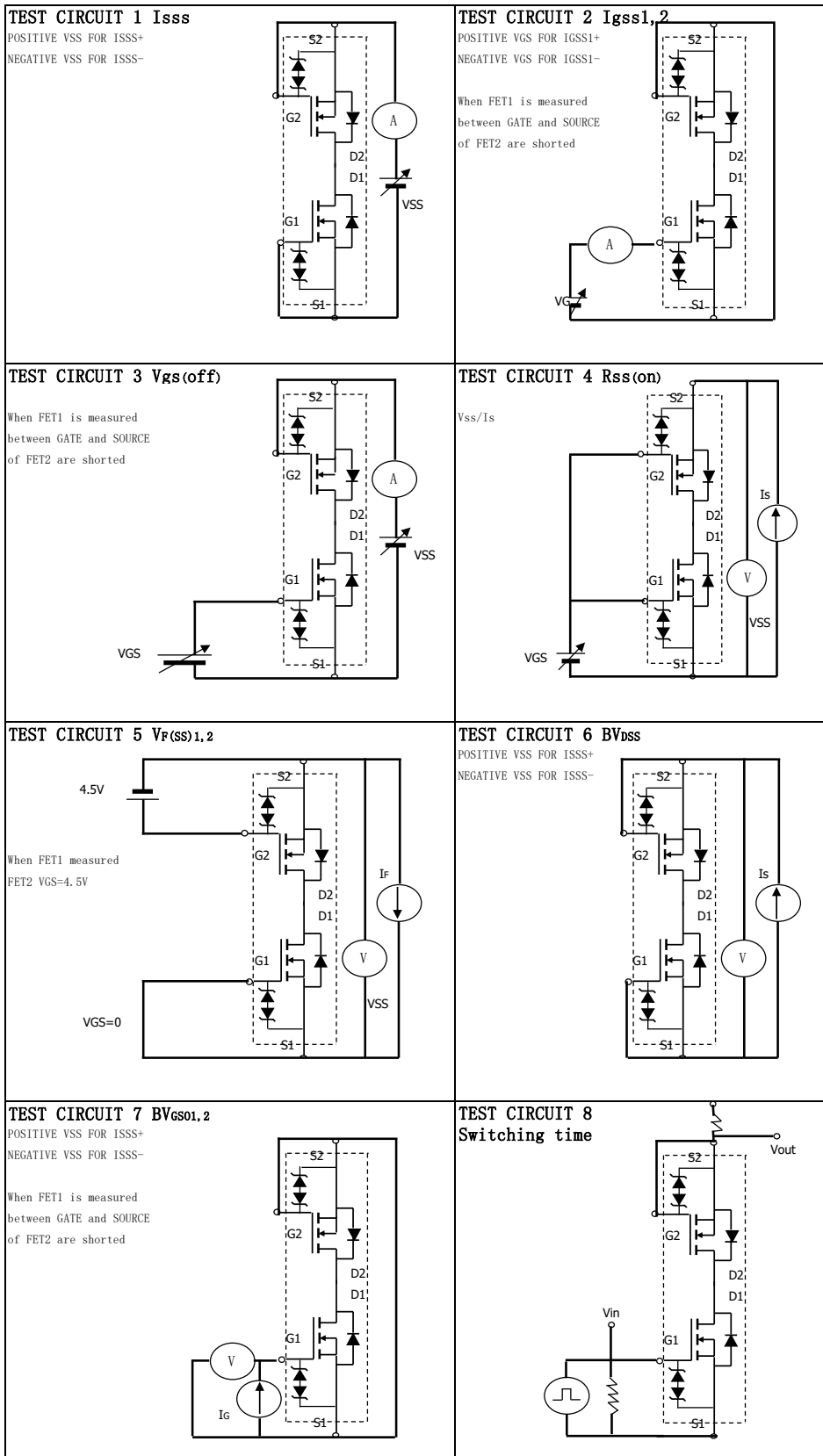
**Figure 9: Maximum Forward Biased Safe Operating Area (Note1)**



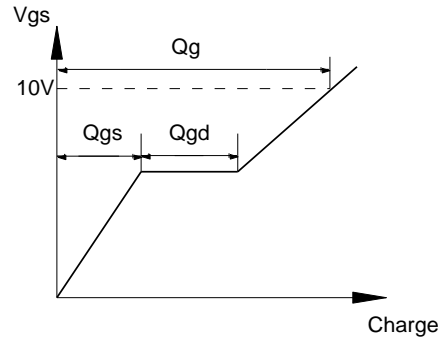
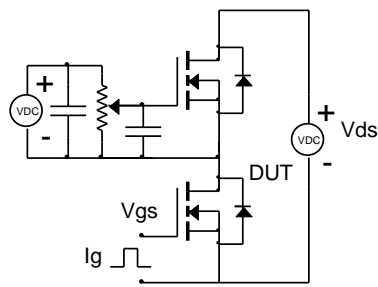
**Figure 10: Single Pulse Power Rating Junction-to-Ambient (Note1)**



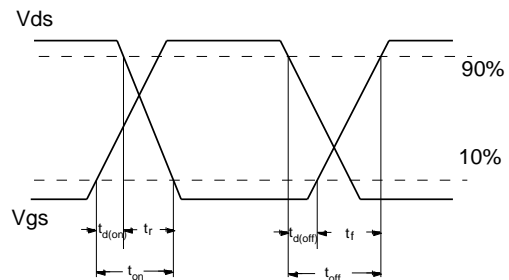
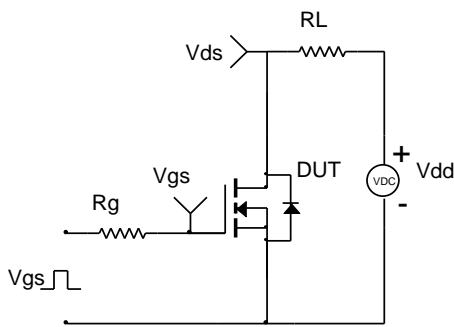
**Figure 11: Normalized Maximum Transient Thermal Impedance (Note1)**



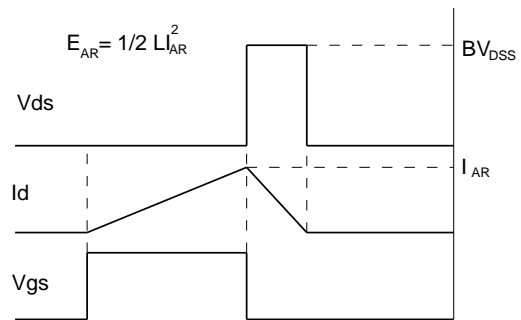
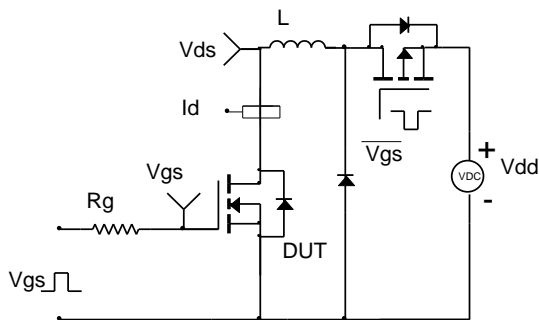
**Gate Charge Test Circuit & Waveform**



**Resistive Switching Test Circuit & Waveforms**



**Unclamped Inductive Switching (UIS) Test Circuit & Waveforms**



**Diode Recovery Test Circuit & Waveforms**

