

Features

- Proprietary α SiC MOSFET technology
- Low loss, with low $R_{DS,ON}$
- Fast switching with low R_G and low capacitance
- Optimized gate drive voltage ($V_{GS} = 15V$)
- Low reverse recovery diode (Q_{rr})

Applications

Renewable

- EV Charger
- Solar Inverters

Industrial

- UPS
- SMPS
- Motor Drives

Pin Configuration

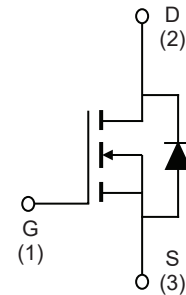
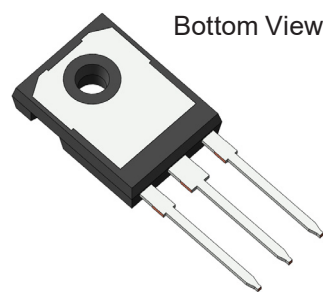
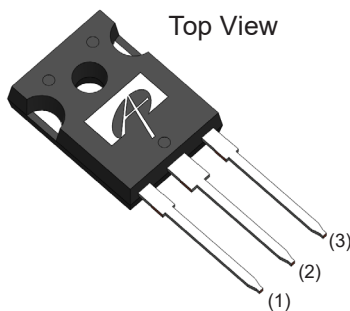

Product Summary

$V_{DS} @ T_{J, max}$	1200V
I_{DM}	10A
$R_{DS(ON), typ}$	500m Ω
Q_{rr}	50nC
$E_{OSS} @ 800V$	6 μ J
100% UIS Tested	

Part Number	Package Type	Form	Shipping Quantity
AOK500V120X2	TO-247-3L	Tube	30/Tube

Absolute Maximum Ratings

$T_A = 25^\circ C$, unless otherwise specified.

Symbol	Parameter	AOK500V120X2	Units
V_{DS}	Drain-Source Voltage	1200	V
$V_{GS,MAX}$	Gate-Source Voltage	Maximum	-8/+18
$V_{GS,OP,TRANS}$		Max Transient ^(A)	-8/+20
$V_{GS,OP}$		Recommended Operating ^(B)	-5/+15
I_D	Continuous Drain Current	$T_C = 25^\circ C$	6.3
		$T_C = 100^\circ C$	4.5
I_{DM}	Pulsed Drain Current ^(C)	10	A
E_{AS}	Single Pulsed Avalanche Energy ^(D)	40	mJ
P_D	Power Dissipation ^(C)	$T_C = 25^\circ C$	44
T_J, T_{STG}	Junction and Storage Temperature Range	-55 to 175	$^\circ C$
T_L	Maximum lead temperature for soldering purpose, 1/8" from case for 5 seconds	300	$^\circ C$

Thermal Characteristics

Symbol	Parameter	AOK500V120X2	Units
$R_{\theta JA}$	Maximum Junction-to-Ambient ^(E,F)	40	°C/W
$R_{\theta JC}$	Maximum Junction-to-Case ^(G)	3.4	°C/W

Electrical Characteristics

$T_A = 25^\circ\text{C}$, unless otherwise specified.

Symbol	Parameter	Conditions	Min	Typ	Max	Units	
Static Parameters							
BV_{DSS}	Drain-Source Breakdown Voltage	$I_D = 250\ \mu\text{A}$, $V_{GS} = 0\ \text{V}$, $T_J = 25^\circ\text{C}$	1200			V	
		$I_D = 250\ \mu\text{A}$, $V_{GS} = 0\ \text{V}$, $T_J = 150^\circ\text{C}$		1200			
I_{DSS}	Zero Gate Voltage Drain Current	$V_{DS} = 1200\ \text{V}$, $V_{GS} = 0\ \text{V}$			100	μA	
I_{GSS}	Gate-Body Leakage Current	$V_{DS} = 0\ \text{V}$, $V_{GS} = +15/-5\ \text{V}$			+/-100	nA	
$V_{GS(th)}$	Gate Threshold Voltage	$V_{DS} = V_{GS}$, $I_D = 1.2\ \text{mA}$	1.8	2.8	3.5	V	
$R_{DS(on)}$	Static Drain-Source On-Resistance	$V_{GS} = 15\ \text{V}$, $I_D = 1.2\ \text{A}$	$T_J = 25^\circ\text{C}$		500	675	m Ω
			$T_J = 150^\circ\text{C}$		700		
g_{FS}	Forward Transconductance	$V_{DS} = 20\ \text{V}$, $I_D = 1.2\ \text{A}$		0.55		S	
V_{SD}	Diode Forward Voltage	$I_S = 1.2\ \text{A}$, $V_{GS} = -5\ \text{V}$		4	5	V	
Dynamic Parameters							
C_{iss}	Input Capacitance	$V_{GS} = 0\ \text{V}$, $V_{DS} = 800\ \text{V}$, $f = 1\ \text{MHz}$		206		pF	
C_{oss}	Output Capacitance			13.5		pF	
C_{rss}	Reverse Transfer Capacitance			1.6		pF	
E_{oss}	C_{oss} Stored Energy			6		μJ	
R_g	Gate Resistance	$f = 1\ \text{MHz}$		5.8		Ω	
Switching Parameters							
Q_g	Total Gate Charge	$V_{GS} = -5/+15\ \text{V}$, $V_{DS} = 800\ \text{V}$, $I_D = 1.2\ \text{A}$		12		nC	
Q_{gs}	Gate Source Charge			2.6		nC	
Q_{gd}	Gate Drain Charge			7.6		nC	
$t_{d(on)}$	Turn-On Delay Time	$V_{GS} = -5\ \text{V}/+15\ \text{V}$, $V_{DS} = 800\ \text{V}$, $I_D = 3\ \text{A}$, $R_{G,ON} = 2\ \Omega$, $R_{G,OFF} = 0\ \Omega$ $L = 120\ \mu\text{H}$ FWD: AOK500V120X2		5		ns	
t_r	Turn-On Rise Time			15		ns	
$t_{d(off)}$	Turn-Off Delay Time			8.6		ns	
t_f	Turn-Off Fall Time			23		ns	
E_{on}	Turn-On Energy			57		μJ	
E_{off}	Turn-Off Energy			13		μJ	
E_{tot}	Total Switching Energy			70		μJ	

t_{rr}	Body Diode Reverse Recovery Time	$I_F = 3A, di/dt = 1500A/\mu s,$ $V_{DS} = 800V$	45	ns
I_{rm}	Peak Reverse Recovery Current		2.9	A
Q_{rr}	Body Diode Reverse Recovery Charge		50	nC

Notes:

- A. < 1% duty cycle, $f > 1Hz$
- B. Device can be operated at $V_{GS} = 0/15V$. Actual operating VGS will depend on application specifics such as parasitic inductance and dV/dt but should not exceed maximum ratings.
- C. The power dissipation P_D is based on $T_{J(MAX)} = 175^\circ C$, using junction-to-case thermal resistance, and is more useful in setting the upper dissipation limit for cases where additional heatsinking is used.
- D. $L = 5mH, I_{AS} = 4A, R_G = 25\Omega$, Starting $T_J = 25^\circ C$.
- E. The value of $R_{\theta JA}$ is measured with the device in a still air environment with $T_A = 25^\circ C$.
- F. The $R_{\theta JA}$ is the sum of the thermal impedance from junction to case $R_{\theta JC}$ and case to ambient.
- G. The value of $R_{\theta JC}$ is measured with the device mounted to a large heat-sink, assuming a maximum junction temperature of $T_{J(MAX)} = 175^\circ C$.
- H. The static characteristics in Figures 1 to 8 are obtained using < 300 ms pulses, duty cycle 0.5% max.
- I. These curves are based on $R_{\theta JC}$ which is measured with the device mounted to a large heatsink, assuming a maximum junction temperature of $T_{J(MAX)} = 175^\circ C$. The SOA curve provides a single pulse rating.

Typical Electrical and Thermal Characteristics

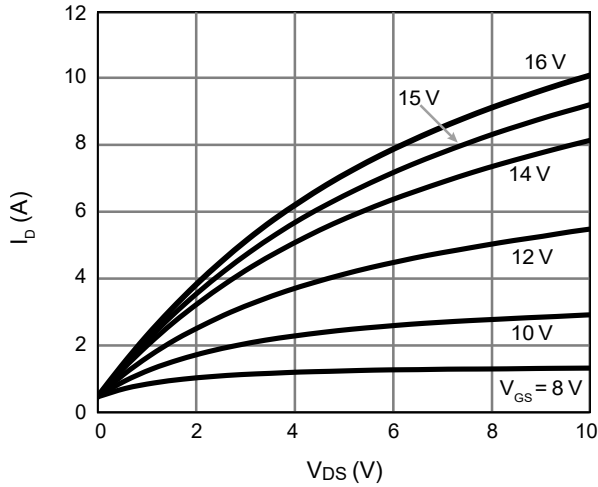

Figure 1. On-Region Characteristics $T_j = 25^\circ\text{C}$

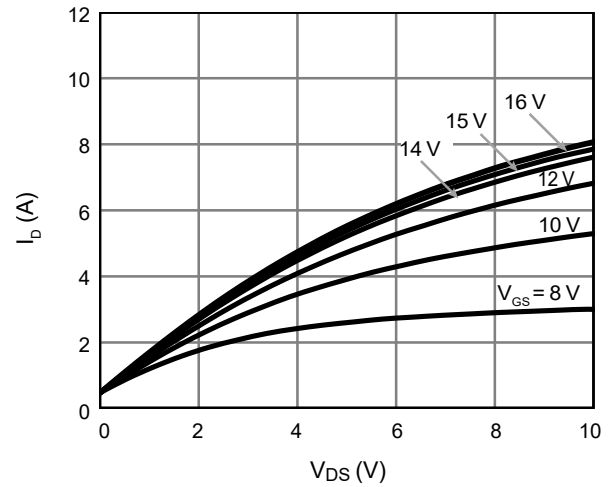

Figure 2. On-Region Characteristics $T_j = 175^\circ\text{C}$

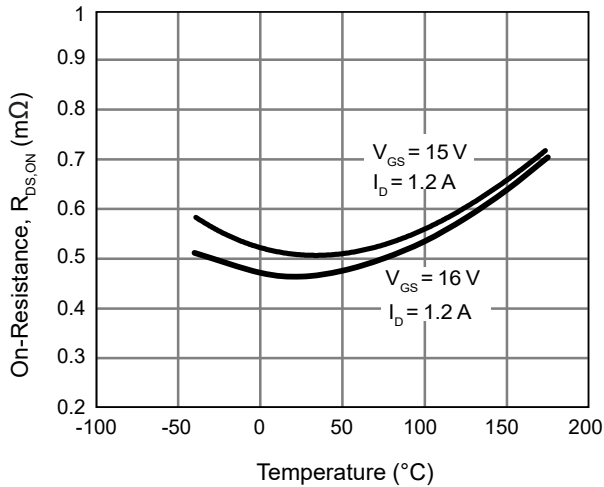

Figure 3. On-Resistance vs. Junction Temperature

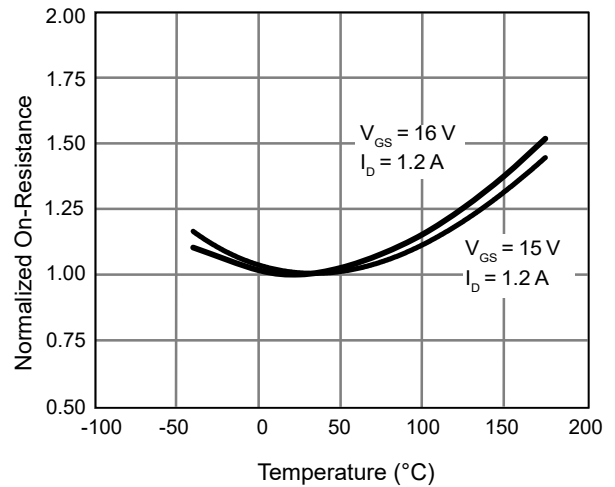

Figure 4. Normalized On-Resistance vs. Junction Temperature

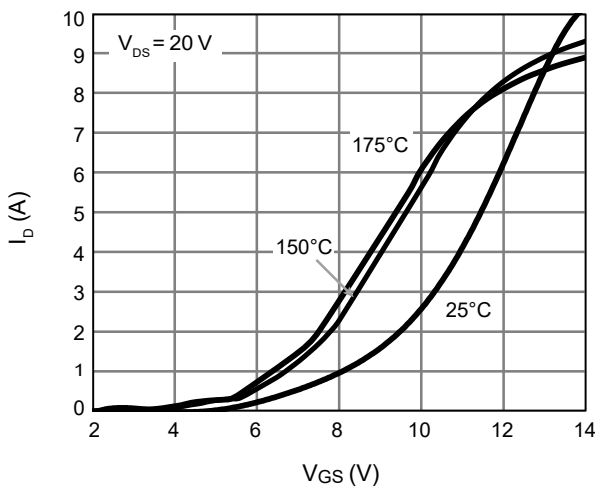

Figure 5. Transfer Characteristics

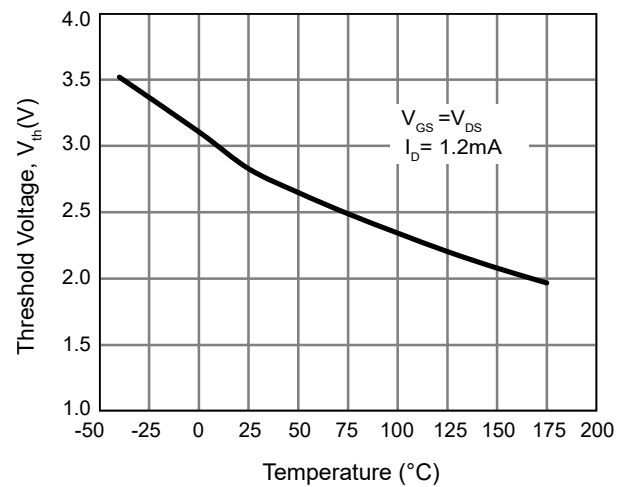

Figure 6. Threshold Voltage vs. Junction Temperature

Typical Electrical and Thermal Characteristics (Continued)

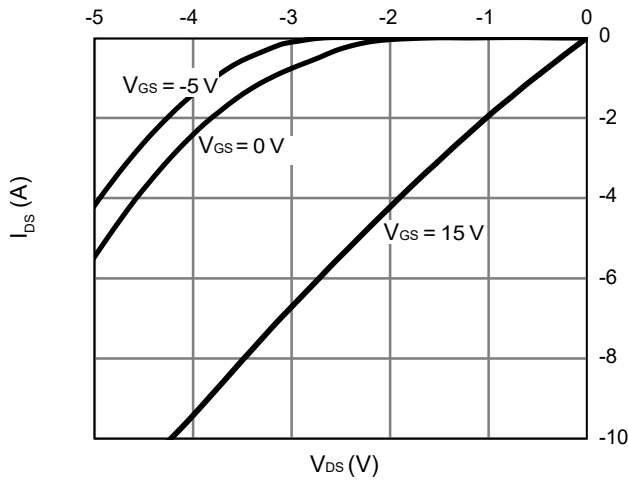

Figure 7. Body-Diode Characteristics at 25°C

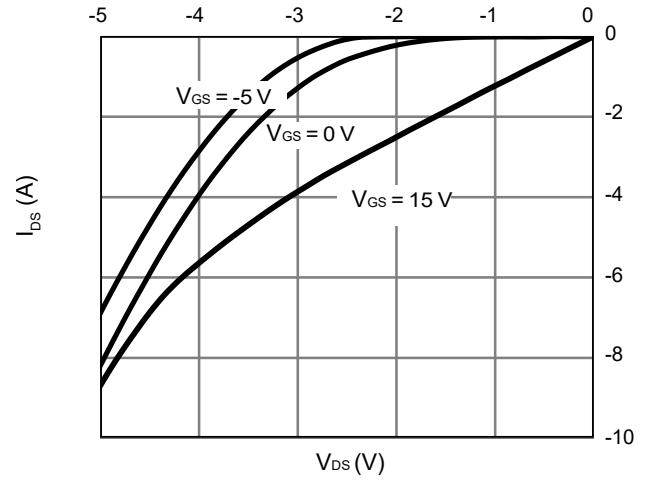

Figure 8. Body-Diode Characteristics at 175°C

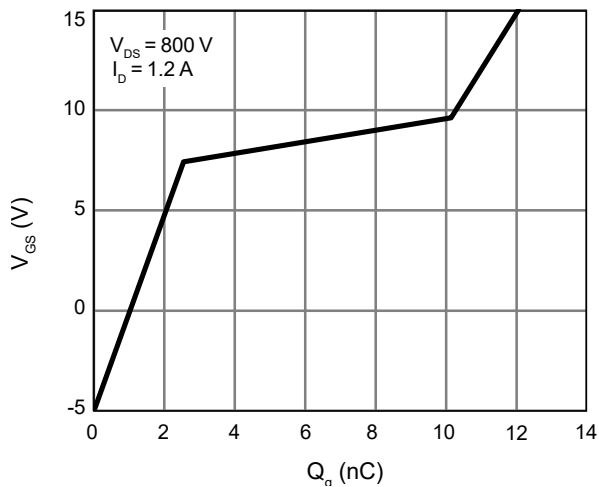

Figure 9. Gate-Charge Characteristics

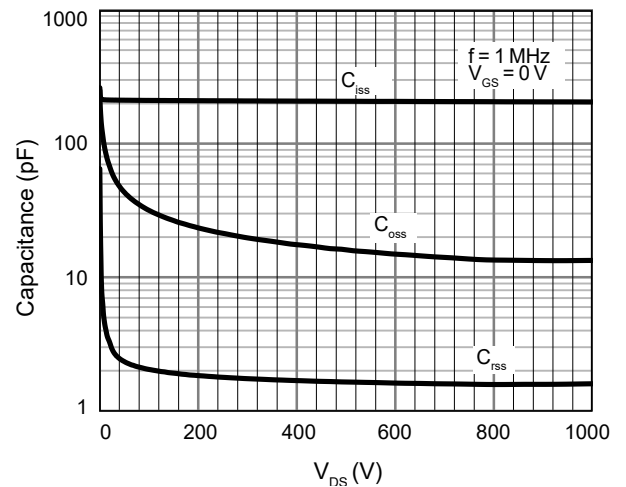

Figure 10. Capacitance Characteristics

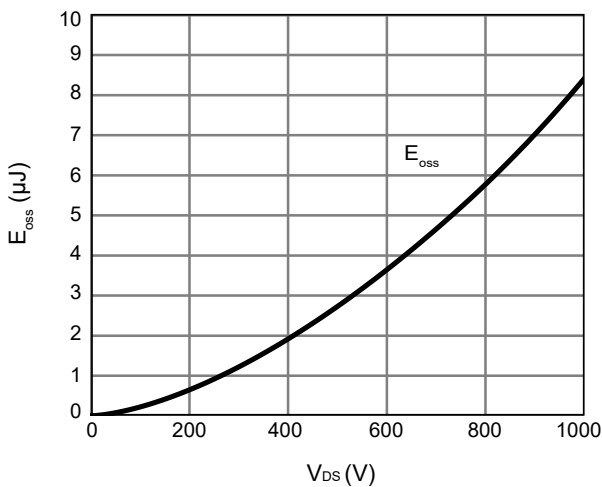

Figure 11. C_{OSS} stored Energy

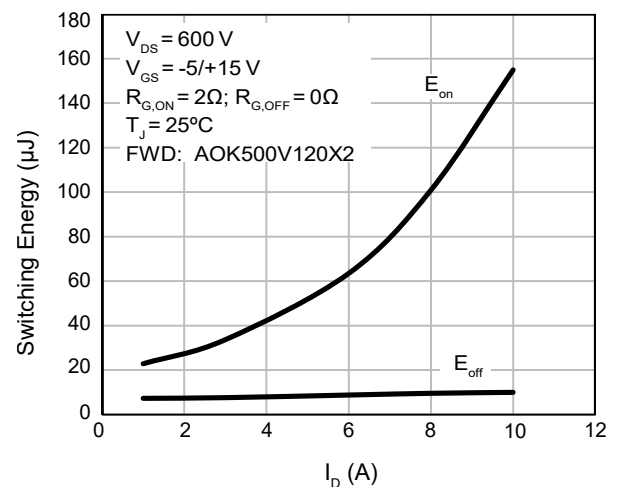

Figure 12. Switching Energy vs. Drain Current

Typical Electrical and Thermal Characteristics (Continued)

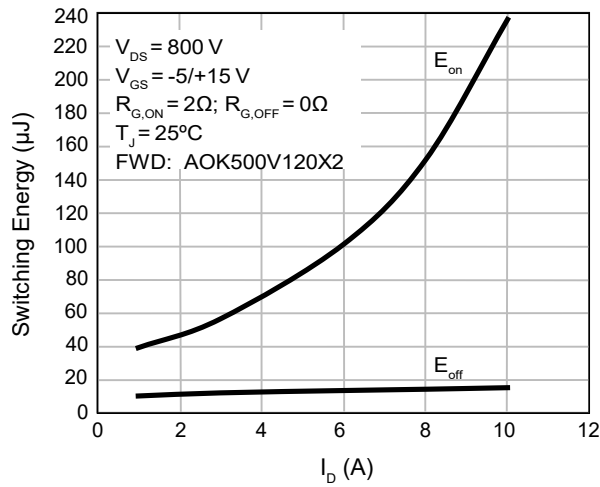

Figure 13. Switching Energy vs. Drain Current

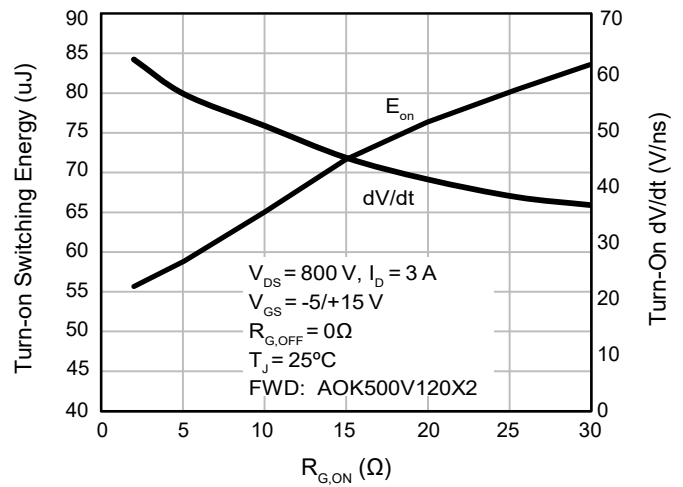

Figure 14. Turn-on Energy and dV/dt vs. External Gate Resistance

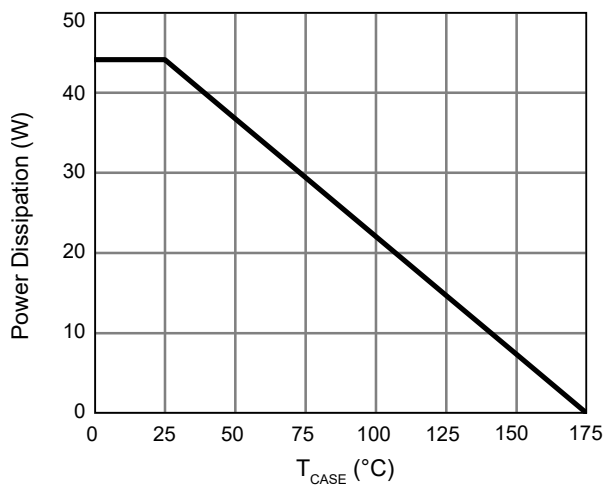

Figure 15. Power De-rating (Note I)

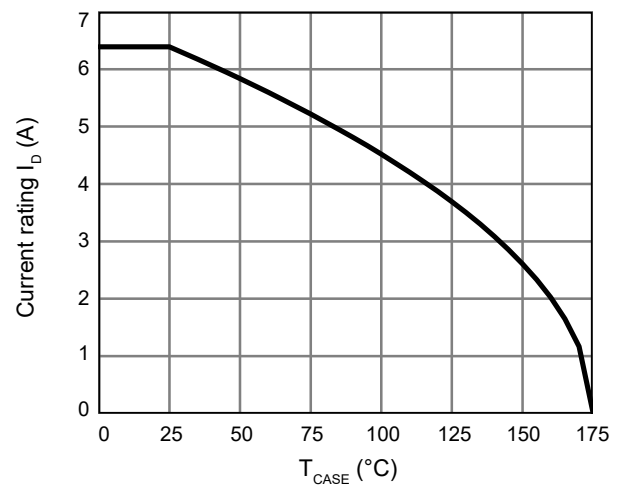

Figure 16. Current De-rating (Note I)

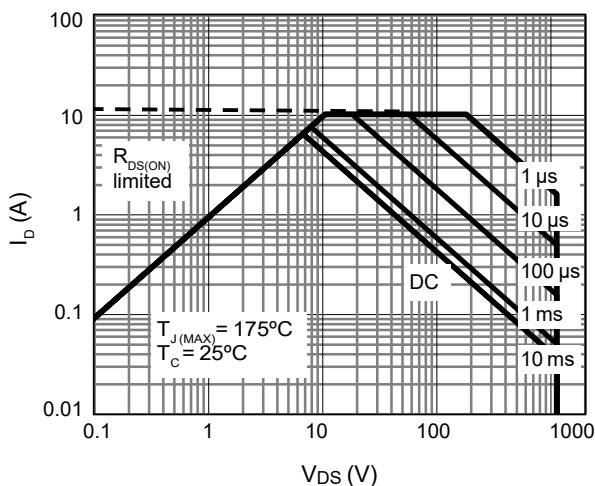

Figure 17. Maximum Forward Biased Safe Operating Area for AOK500V120X2 (Note I)

Typical Electrical and Thermal Characteristics (Continued)

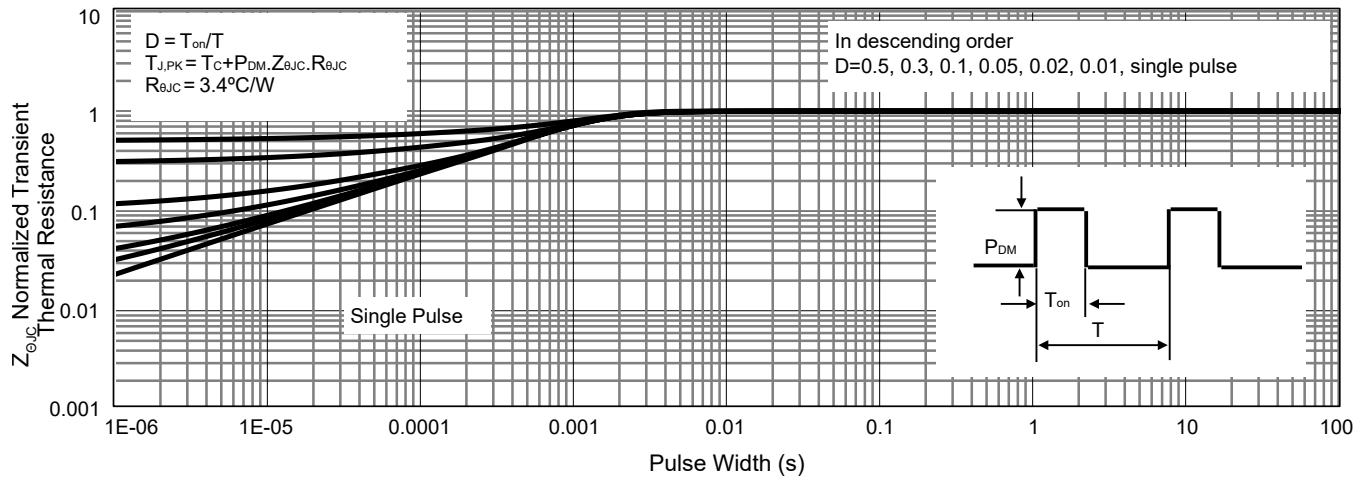

Figure 18. Normalized Maximum Transient Thermal Impedance for AOK500V120X2 (Note I)

Test Circuits and Waveforms

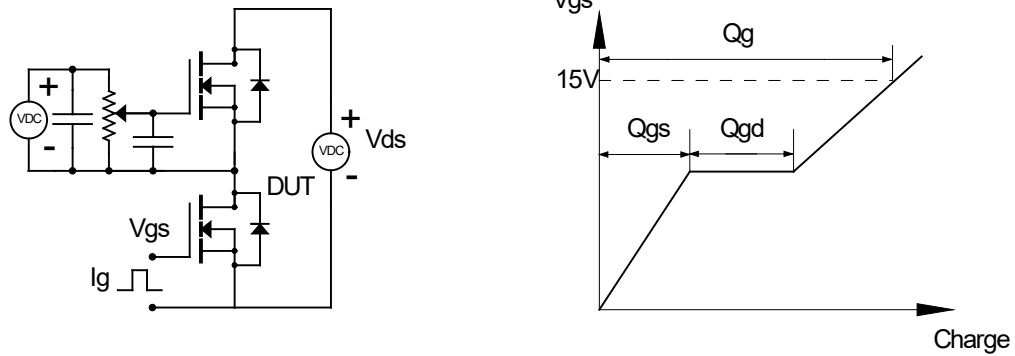

Figure 19. Gate Charge Test Circuits and Waveforms

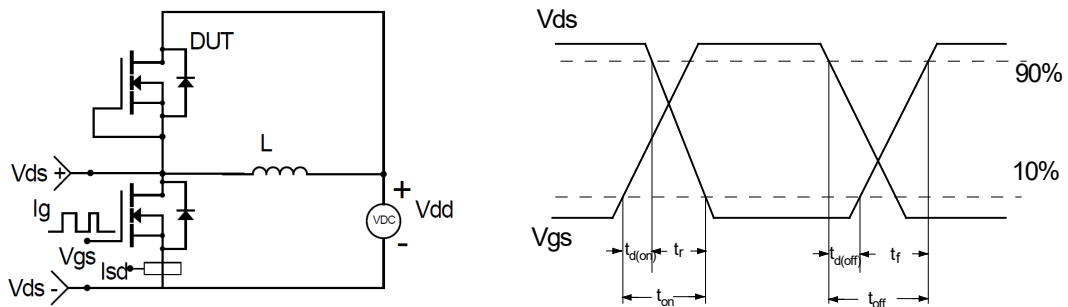

Figure 20. Inductive Switching Test Circuit and Waveforms

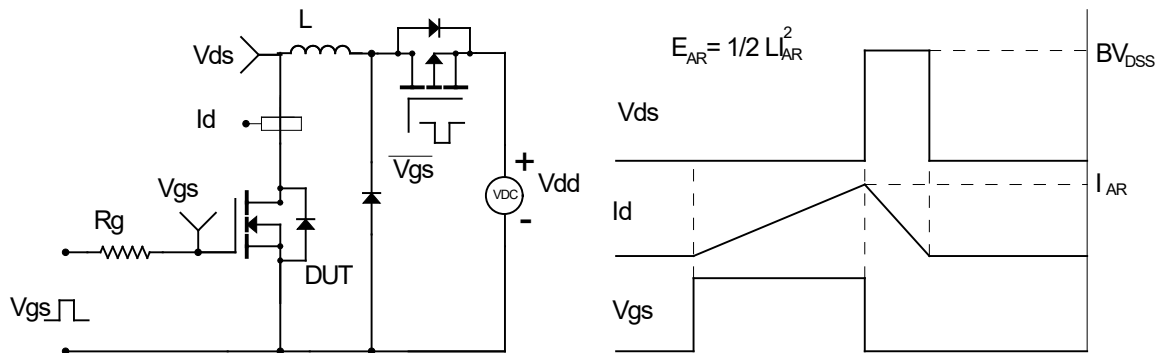

Figure 21. Unclamped Inductive Switching (UIS) Test Circuit and Waveforms

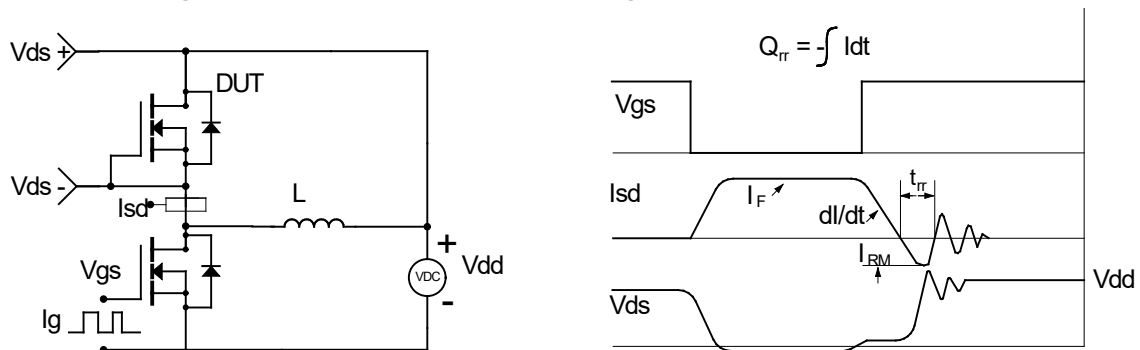
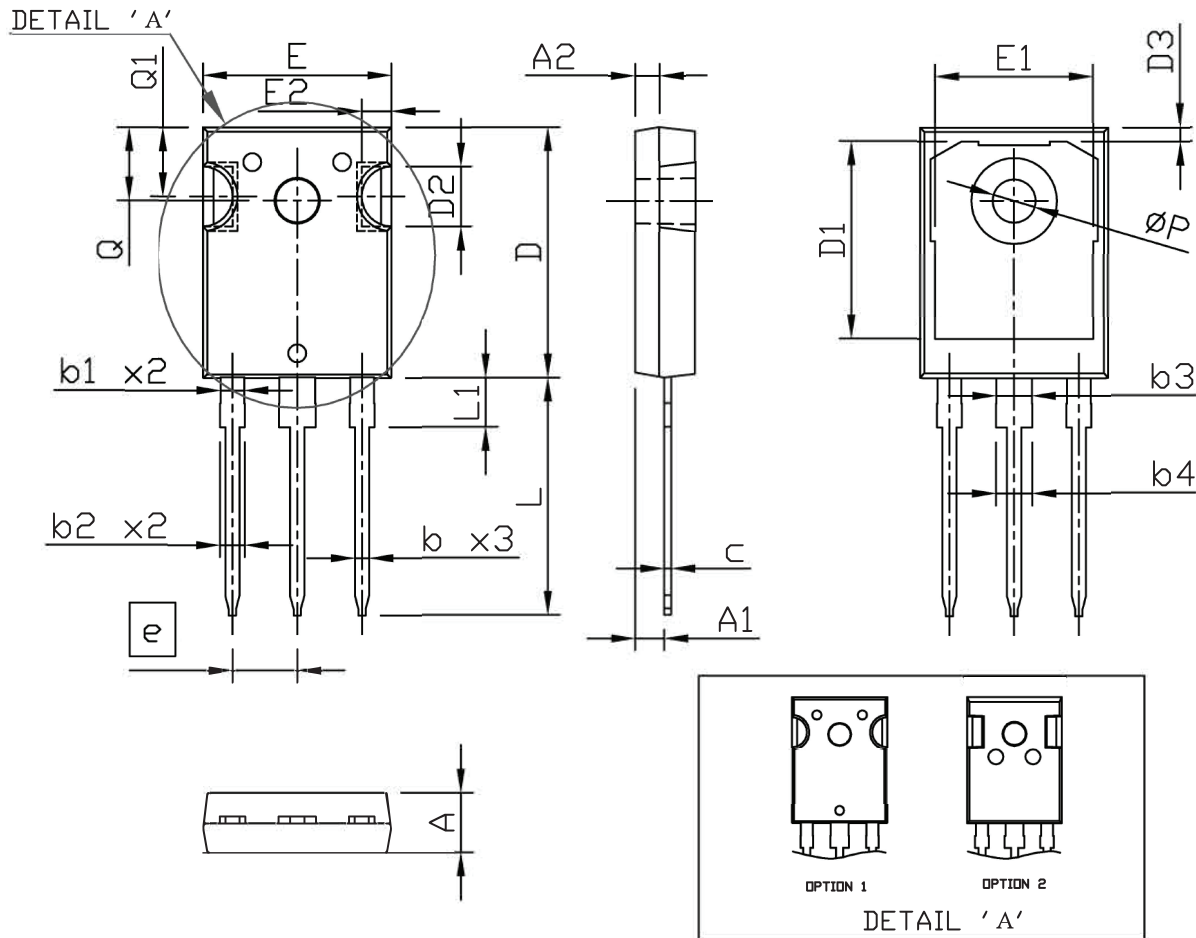
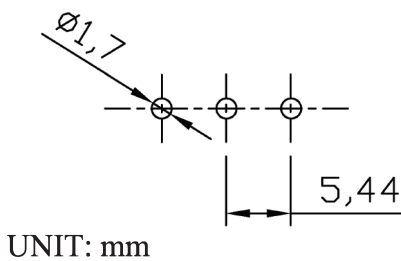

Figure 22. Diode Recovery Test Circuits and Waveforms

Package Dimensions, TO-247-3L



RECOMMENDED LAND PATTERN



SYMBOLS	DIMENSIONS IN MILLIMETERS			DIMENSIONS IN INCHES		
	MIN	NOM	MAX	MIN	NOM	MAX
A	4.90	5.00	5.10	0.193	0.197	0.201
A1	2.31	2.42	2.52	0.091	0.095	0.099
A2	1.90	2.00	2.10	0.075	0.079	0.083
b	1.16	1.22	1.27	0.046	0.048	0.050
b1	1.96	2.02	2.07	0.078	0.080	0.081
b2	2.00	2.10	2.20	0.079	0.083	0.087
b3	2.96	3.02	3.07	0.117	0.119	0.121
b4	3.00	3.10	3.20	0.118	0.122	0.126
c	0.59	0.62	0.66	0.023	0.024	0.026
D	20.90	21.00	21.10	0.823	0.827	0.831
D1	16.25	16.55	16.85	0.640	0.652	0.663
D2	5.00 TYP			0.197 TYP		
D3	1.05	1.20	1.35	0.041	0.047	0.053
e	5.44 BSC			0.214 BSC		
E	15.70	15.80	15.90	0.618	0.622	0.626
E1	13.06	13.26	13.50	0.514	0.522	0.530
E2	2.50 TYP			0.098 TYP		
L	19.72	19.92	20.12	0.776	0.784	0.792
L1	---	---	4.30	---	---	0.169
Q	6.15 BSC			0.242 BSC		
Q1	5.60	5.80	6.00	0.220	0.228	0.236
ØP	3.55	3.60	3.70	0.140	0.142	0.146

NOTE

1. PACKAGE BODY SIZES EXCLUDE MOLD FLASH AND GATE BURRS.
MOLD FLASH AT THE NON-LEAD SIDES SHOULD BE LESS THAN 6 MILS EACH.
2. CONTROLLING DIMENSION IS MILLIMETER.
CONVERTED INCH DIMENSIONS ARE NOT NECESSARILY EXACT.

Part Marking

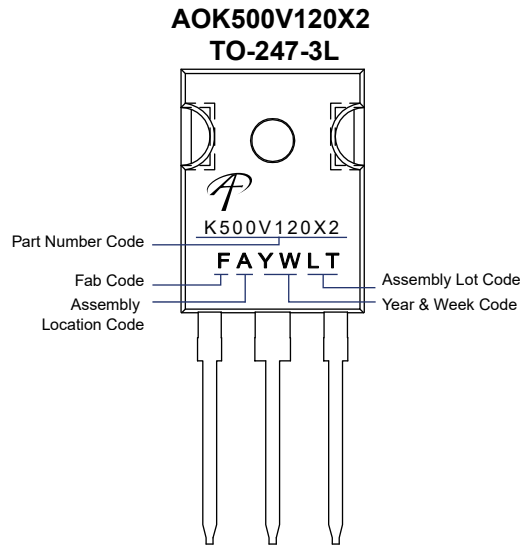

LEGAL DISCLAIMER

Applications or uses as critical components in life support devices or systems are not authorized. Alpha and Omega Semiconductor does not assume any liability arising out of such applications or uses of its products. AOS reserves the right to make changes to product specifications without notice. It is the responsibility of the customer to evaluate suitability of the product for their intended application. Customer shall comply with applicable legal requirements, including all applicable export control rules, regulations and limitations.

AOS's products are provided subject to AOS's terms and conditions of sale which are set forth at:

http://www.aosmd.com/terms_and_conditions_of_sale

LIFE SUPPORT POLICY

ALPHA AND OMEGA SEMICONDUCTOR PRODUCTS ARE NOT AUTHORIZED FOR USE AS CRITICAL COMPONENTS IN LIFE SUPPORT DEVICES OR SYSTEMS.

As used herein:

1. Life support devices or systems are devices or systems which, (a) are intended for surgical implant into the body or (b) support or sustain life, and (c) whose failure to perform when properly used in accordance with instructions for use provided in the labeling, can be reasonably expected to result in a significant injury of the user.
2. A critical component in any component of a life support, device, or system whose failure to perform can be reasonably expected to cause the failure of the life support device or system, or to affect its safety or effectiveness.