

Features

- Proprietary α SiC MOSFET technology
- Low loss, with low $R_{DS, ON}$
- Fast switching with low R_G and low capacitance
- Flexible gate voltage range ($V_{GS} = 15$ to $18V$)
- Low reverse recovery diode (Q_{rr})
- AEC-Q101 Automotive Qualified

Product Summary

| | |
|-----------------------|---------------|
| $V_{DS} @ T_{J, max}$ | 1200V |
| I_{DM} | 100A |
| $R_{DS(ON), typ}$ | 40 m Ω |
| Q_{rr} | 143 nC |
| $E_{OSS} @ 800V$ | 44 μ J |
| 100% UIS Tested | |

Applications

- xEV Charger
- Electric Vehicle Supply Equipment (EVSE)
- Motor Drives
- Automotive Inverters



Pin Configuration

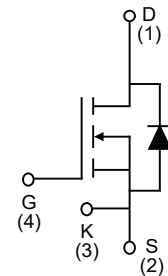
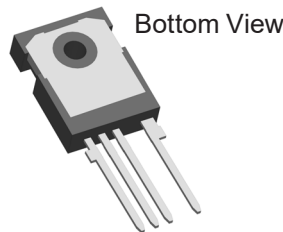
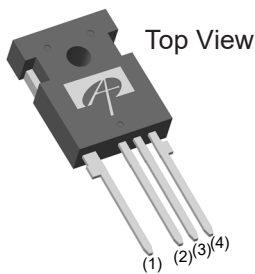

| Ordering Part Number | Package Type | Form | Shipping Quantity |
|----------------------|--------------|------|-------------------|
| AOM040V120X2Q | TO-247-4L | Tube | 30/Tube |

Absolute Maximum Ratings

($T_A = 25^\circ C$, unless otherwise noted)

| Symbol | Parameter | AOM040V120X2Q | Units |
|---------------------|--|--|------------|
| V_{DS} | Drain-Source Voltage | 1200 | V |
| $V_{GS, OP, TRANS}$ | Gate Source Voltage | Max Transient ^(A) | -8/+22 |
| $V_{GS, OP}$ | | Recommended Operating Range ^(B) | -5/+18 |
| I_D | Continuous Drain Current | $T_C = 25^\circ C, V_{GS} = 18V$ | 50 |
| | | $T_C = 100^\circ C, V_{GS} = 18V$ | 35 |
| I_{DM} | Pulsed Drain Current ^(C) | 100 | A |
| E_{AS} | Single Pulsed Avalanche Energy ^(D) | 640 | mJ |
| P_D | Power Dissipation ^(C) | 230 | W |
| T_J, T_{STG} | Junction and Storage Temperature Range | -55 to 175 | $^\circ C$ |
| T_L | Maximum lead temperature for soldering purpose, 1/8" from case for 5 seconds | 300 | $^\circ C$ |

Thermal Characteristics

| Symbol | Parameter | Typ | Max | Units |
|------------------|--|------|------|-------|
| R _{θJA} | Maximum Junction-to-Ambient ^(E,F) | | 40 | °C/W |
| R _{θJC} | Maximum Junction-to-Case ^(G) | 0.54 | 0.65 | °C/W |

Electrical Characteristics

(T_A = 25°C, unless otherwise noted)

| Symbol | Parameter | Conditions | Min | Typ | Max | Units |
|--------------------------|------------------------------------|--|------------------------|------|------|-------|
| STATIC PARAMETERS | | | | | | |
| BV _{DSS} | Drain-Source Breakdown Voltage | I _D = 250 μA, V _{GS} = 0 V, T _J = 25°C | 1200 | | | V |
| | | I _D = 250 μA, V _{GS} = 0 V, T _J = 150°C | 1200 | | | V |
| I _{DSS} | Zero Gate Voltage Drain Current | V _{DS} = 1200 V, V _{GS} = 0 V, T _J = 25°C | | | 100 | μA |
| I _{GSS} | Gate-Body Leakage Current | V _{DS} = 0 V, V _{GS} = +15/-5 V | | | ±200 | nA |
| V _{GS(th)} | Gate Threshold Voltage | V _{DS} = V _{GS} , I _D = 13.2 mA | 1.8 | 2.8 | 3.5 | V |
| R _{DS(on)} | Static Drain-Source On-Resistance | V _{GS} = 15 V, I _D = 13.2 A | T _J = 25°C | 45 | 59 | mΩ |
| | | | T _J = 175°C | 71 | | mΩ |
| | | V _{GS} = 18 V, I _D = 13.2 A | T _J = 25°C | 40 | 52 | mΩ |
| | | | T _J = 175°C | 70 | | mΩ |
| g _{FS} | Forward Transconductance | V _{DS} = 20 V, I _D = 13.2 A | | 10 | | S |
| V _{SD} | Diode Forward Voltage | I _S = 13.2 A, V _{GS} = -5 V | | 4 | 5 | V |
| DYNAMIC | | | | | | |
| C _{iss} | Input Capacitance | V _{GS} = 0 V, V _{DS} = 800 V, f = 1 MHz | | 2316 | | pF |
| C _{oss} | Output Capacitance | | | 103 | | pF |
| C _{rss} | Reverse Transfer Capacitance | | | 14 | | pF |
| E _{oss} | Coss Stored Energy | | | 44 | | μJ |
| R _G | Gate Resistance | f = 1 MHz | | 1.5 | | Ω |
| SWITCHING | | | | | | |
| Q _g | Total Gate Charge | V _{GS} = -5/+18 V, V _{DS} = 800 V, I _D = 13.2 A | | 91 | | nC |
| Q _{gs} | Gate Source Charge | | | 28 | | nC |
| Q _{gd} | Gate Drain Charge | | | 26 | | nC |
| t _{d(on)} | Turn-On Delay Time | V _{GS} = -5 V/+18 V, V _{DS} = 800 V, I _D = 13 A, R _G = 2 Ω L = 60 μH | | 9 | | ns |
| t _r | Turn-On Rise Time | | | 8 | | ns |
| t _{d(off)} | Turn-Off Delay Time | | | 35 | | ns |
| t _f | Turn-Off Fall Time | | | 18 | | ns |
| E _{on} | Turn-On Energy | | | 143 | | μJ |
| E _{off} | Turn-Off Energy | | FWD: AOM040V120X2Q | 35 | | μJ |
| E _{tot} | Total Switching Energy | | | 178 | | μJ |
| t _{rr} | Body Diode Reverse Recovery Time | I _F = 13 A, di/dt = 1500 A/us, V _{GS} = -5 V V _{DS} = 800 V | | 18 | | ns |
| I _{rm} | Peak Reverse Recovery Current | | | 13 | | A |
| Q _{rr} | Body Diode Reverse Recovery Charge | | | 143 | | nC |

Notes:

- t_{pulse} < 1 μs, f > 1 Hz
- Device can be operated at V_{GS} = 0/18 V. Actual operating V_{GS} will depend on application specifics such as parasitic inductance and dV/dt but should not exceed maximum ratings.
- The power dissipation P_D is based on T_{J(MAX)} = 175°C, using junction-to-case thermal resistance, and is more useful in setting the upper dissipation limit for cases where additional heatsinking is used.
- L = 5 mH, I_{AS} = 16 A, R_G = 25 Ω, Starting T_J = 25°C.
- The value of R_{θJA} is measured with the device in a still air environment with T_A = 25°C.
- The R_{θJA} is the sum of the thermal impedance from junction to case R_{θJC} and case to ambient.
- The value of R_{θJC} is measured with the device mounted to a large heat-sink, assuming a maximum junction temperature of T_{J(MAX)} = 175°C.

Typical Electrical and Thermal Characteristics^(H)

$T_A = 25^\circ\text{C}$, unless otherwise specified.

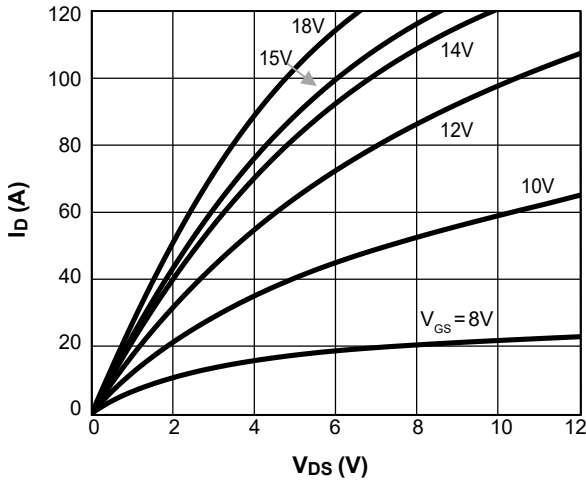

Figure 1. On-Region Characteristics $T_J = 25^\circ\text{C}$

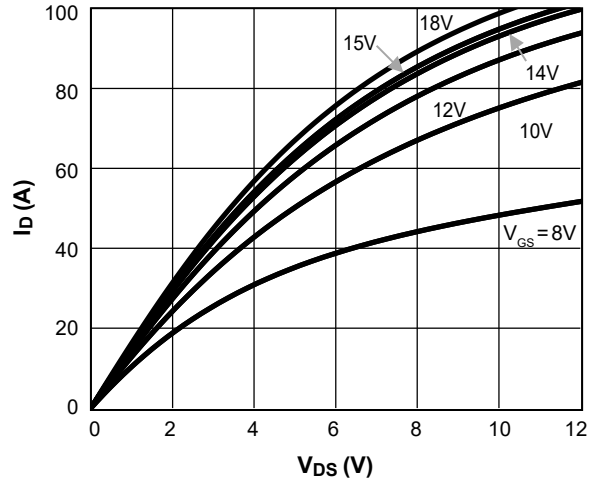

Figure 2. On-Region Characteristics $T_J = 175^\circ\text{C}$

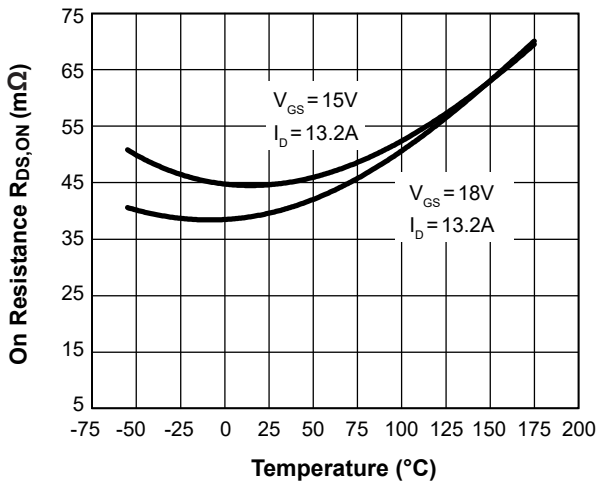

Figure 3. On Resistance vs. Junction Temperature

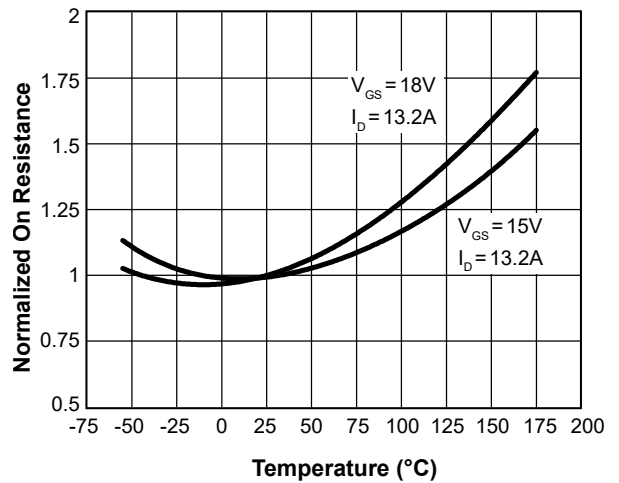

Figure 4. Normalized On Resistance vs. Junction Temperature

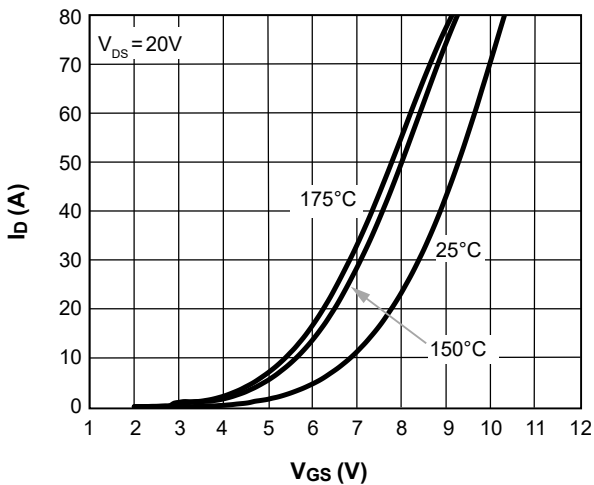

Figure 5. Transfer Characteristics

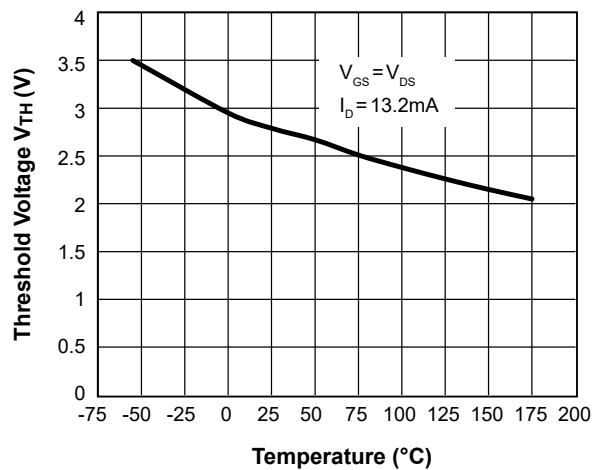

Figure 6. Threshold Voltage vs. Junction Temperature

Typical Electrical and Thermal Characteristics^(H) (Continued)

T_A = 25 °C, unless otherwise specified.

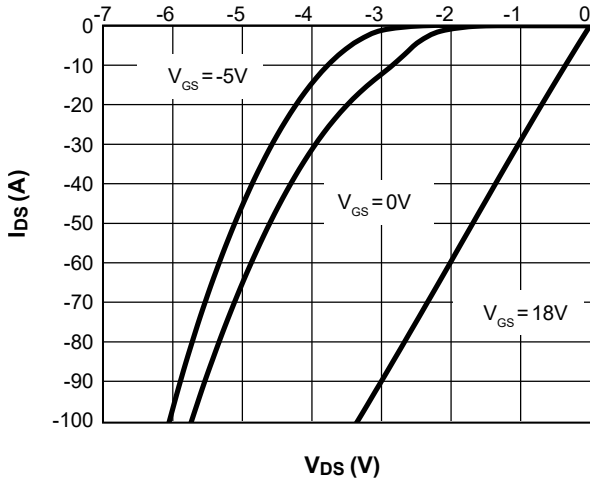

Figure 7. Body-diode Characteristics at 25°C

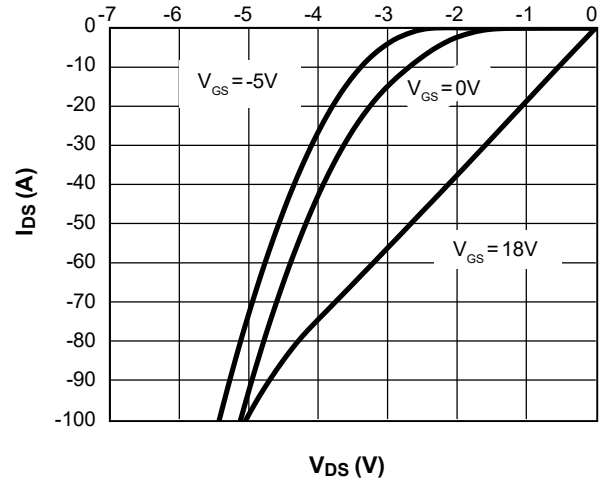

Figure 8. Body-diode Characteristics at 175°C

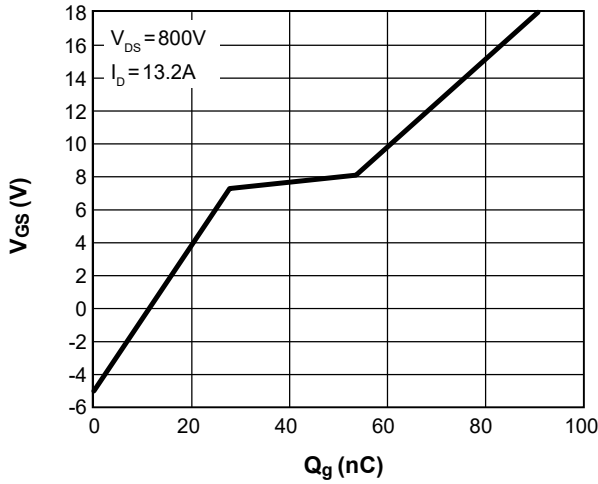

Figure 9. Gate-charge Characteristics

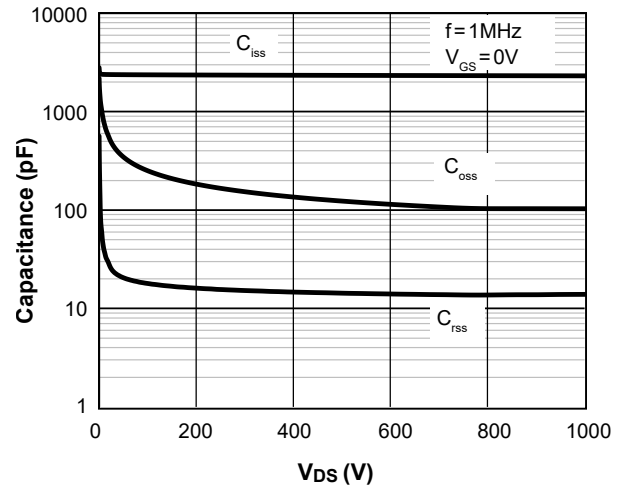

Figure 10. Capacitance Characteristics

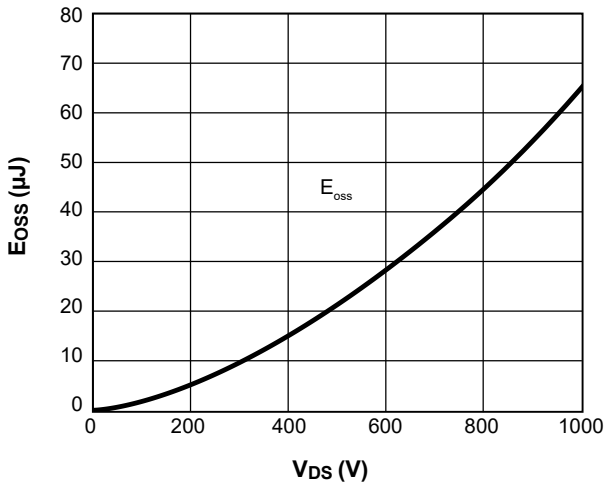

Figure 11. Coss Stored Energy

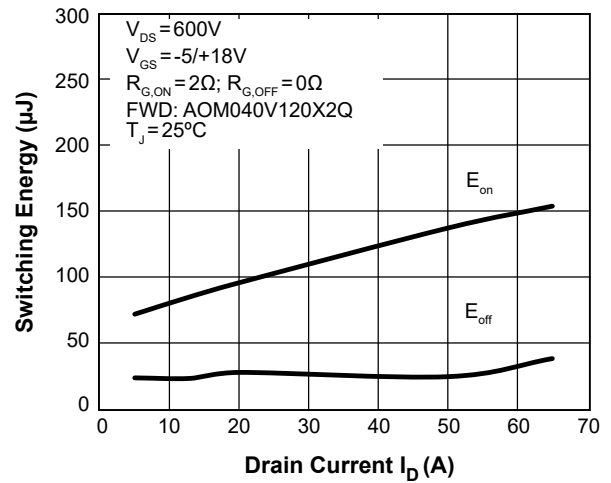

Figure 12. Switching Energy vs. Drain Current

Typical Electrical and Thermal Characteristics (Continued)

T_A = 25 °C, unless otherwise specified.

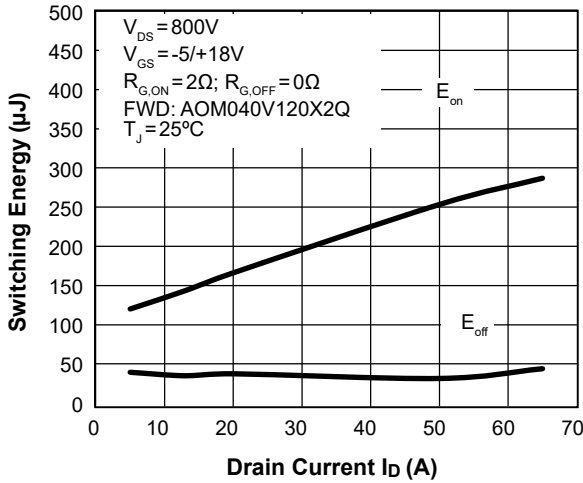

Figure 13. Switching Energy vs. Drain Current

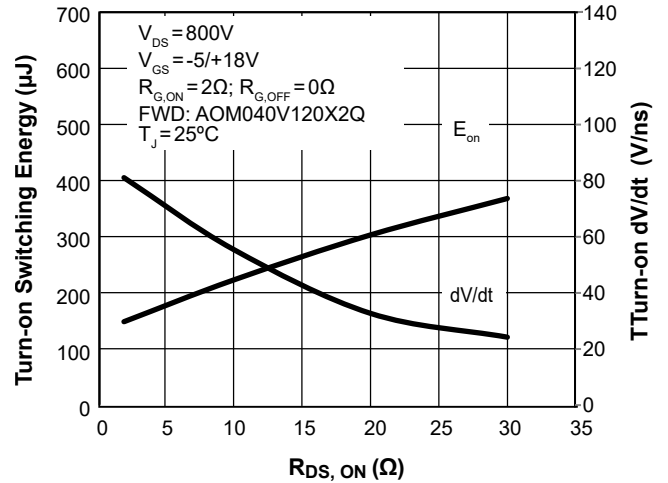

Figure 14. Turn-On Energy and dV/dt vs. External Gate Resistance

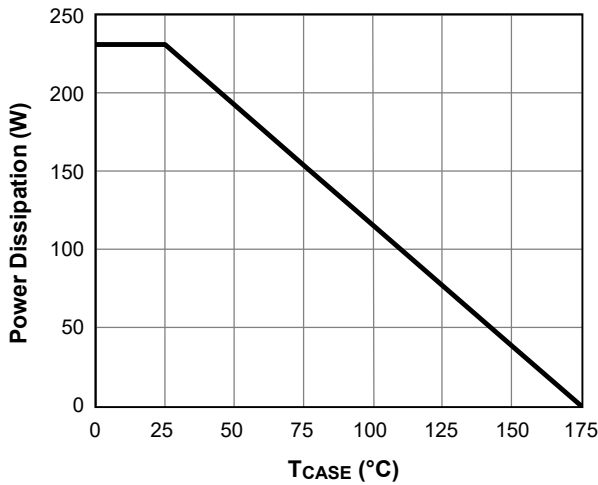

Figure 15. Power De-rating (Note I)

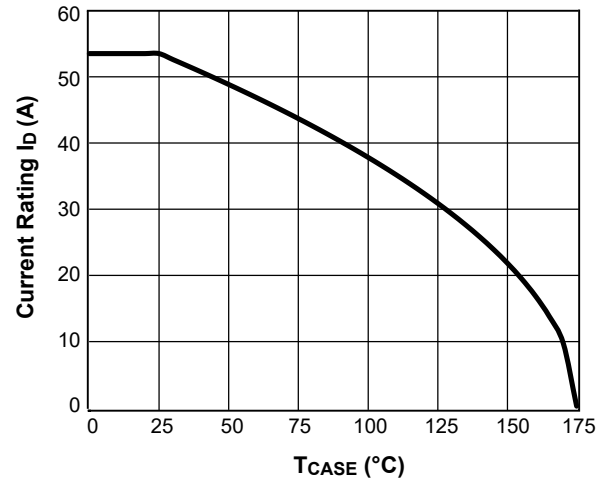

Figure 16. Current De-rating (Note I)

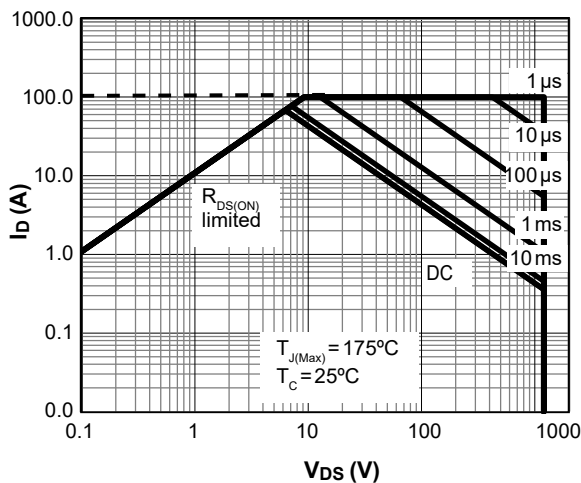

Figure 17. Maximum Forward Biased Safe Operating Area for AOM040V120X2Q (Note I)

Typical Electrical and Thermal Characteristics (Continued)

T_A = 25 °C, unless otherwise specified.

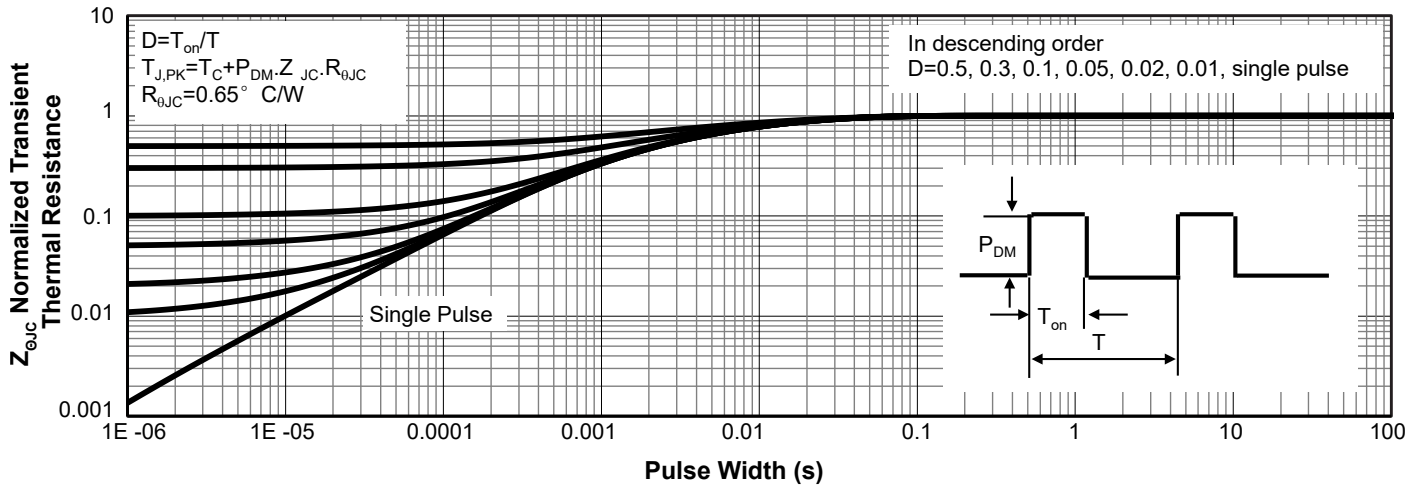

Figure 18. Normalized Maximum Transient Thermal Impedance for AOM040V120X2Q (Note I)

Notes:

- H. The static characteristics in Figures 1 to 8 are obtained using <300ms pulses, duty cycle 0.5% max.
- I. These curves are based on R_{θJC} which is measured with the device mounted to a large heatsink, assuming a maximum junction temperature of T_{J(MAX)} = 175°C. The SOA curve provides a single pulse rating.

Test Circuits and Waveforms

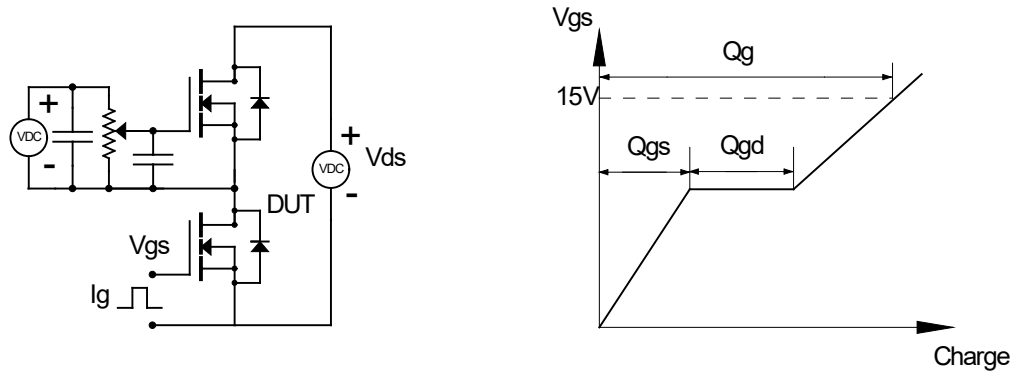

Figure 19. Gate Charge Test Circuits and Waveforms

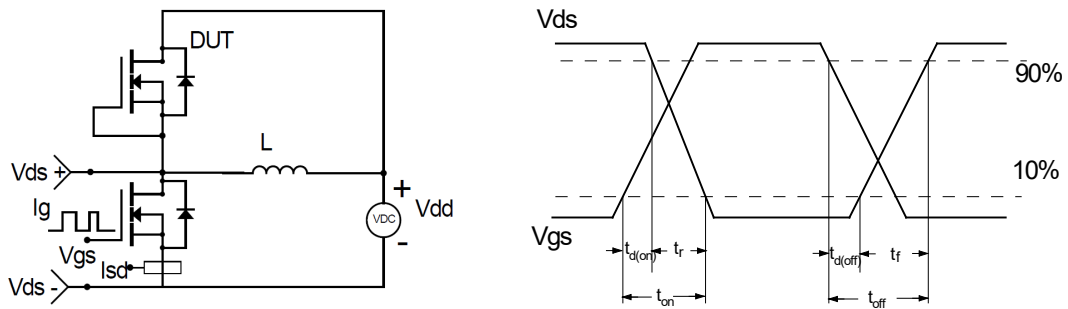

Figure 20. Inductive Switching Test Circuit and Waveforms

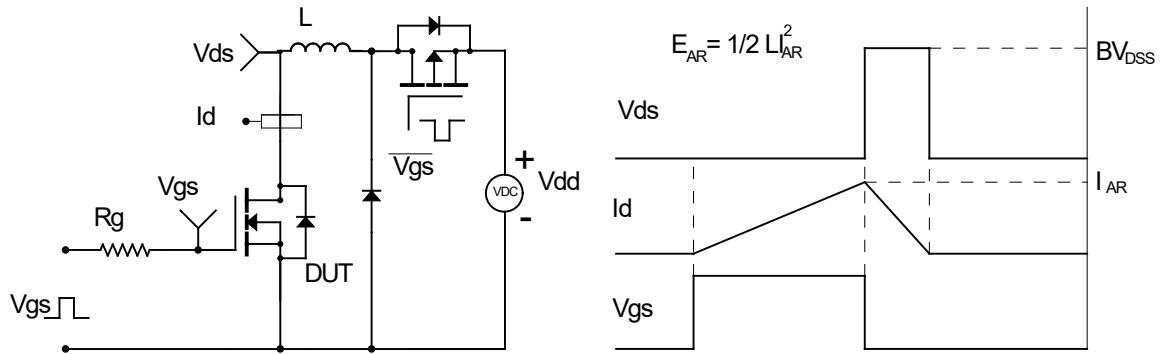

Figure 21. Unclamped Inductive Switching (UIS) Test Circuit and Waveforms

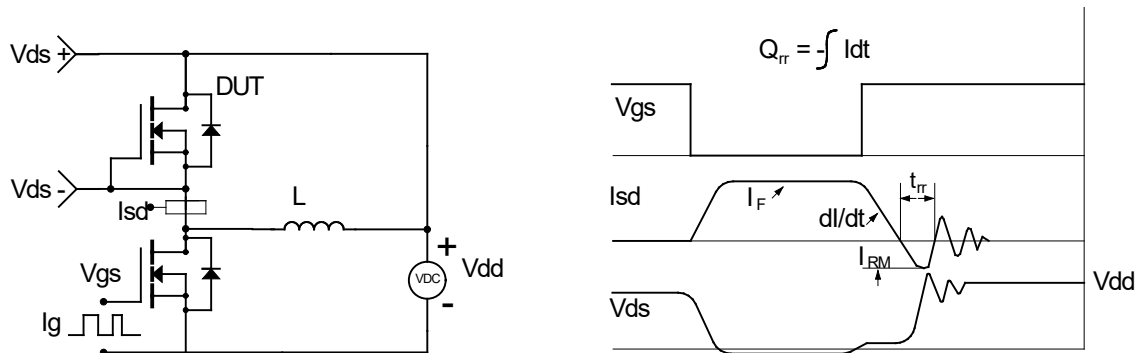
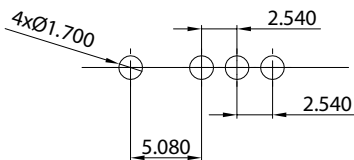
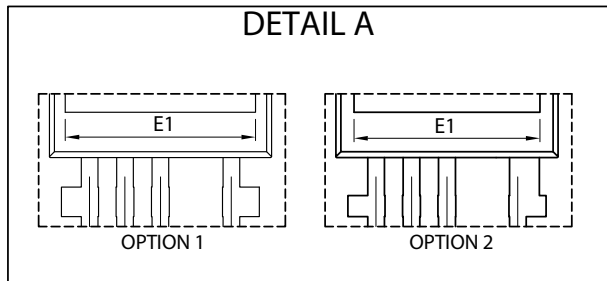
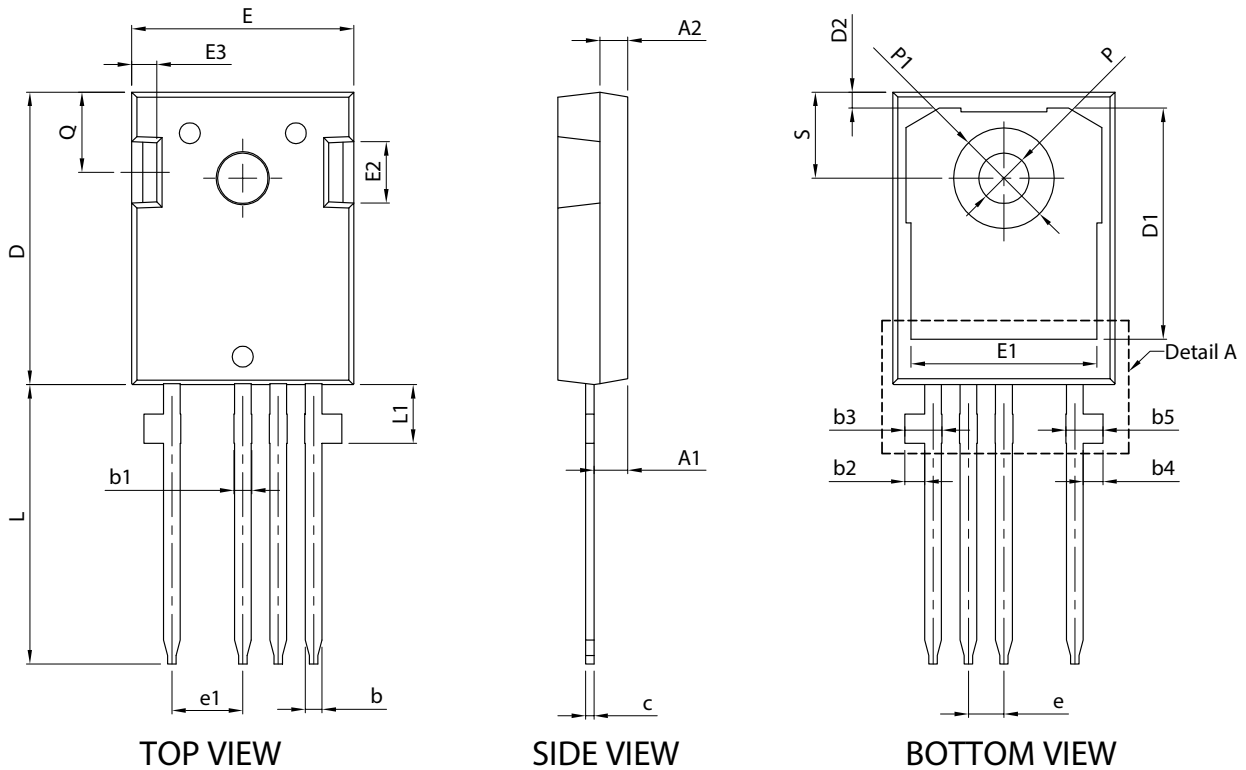

Figure 22. Diode Recovery Test Circuits and Waveforms

Package Dimensions, TO-247-4L



RECOMMENDED THROUGH HOLES FOR LAND PATTERN

| SYMBOLS | DIM. IN MM | | | DIM. IN INCH | | |
|-------------|------------|-------|-------|--------------|-------|-------|
| | MIN. | NOM. | MAX. | MIN. | NOM. | MAX. |
| A | 4.90 | 5.00 | 5.10 | 0.193 | 0.197 | 0.201 |
| A1 | 2.32 | 2.42 | 2.52 | 0.091 | 0.095 | 0.099 |
| A2 | 1.90 | 2.00 | 2.10 | 0.075 | 0.079 | 0.083 |
| b | 1.17 | 1.22 | 1.27 | 0.046 | 0.048 | 0.050 |
| b1 | 1.20 | 1.30 | 1.40 | 0.047 | 0.051 | 0.055 |
| b2 | 1.31 | 1.41 | 1.51 | 0.052 | 0.056 | 0.059 |
| b3 | 2.45 | 2.65 | 2.85 | 0.096 | 0.104 | 0.112 |
| b4 | 1.31 | 1.41 | 1.51 | 0.052 | 0.056 | 0.059 |
| b5 | 2.45 | 2.65 | 2.85 | 0.096 | 0.104 | 0.112 |
| c | 0.57 | 0.62 | 0.67 | 0.022 | 0.024 | 0.026 |
| D | 20.80 | 20.95 | 21.10 | 0.819 | 0.825 | 0.831 |
| D1 | 16.25 | 16.55 | 16.85 | 0.640 | 0.652 | 0.663 |
| D2 | 1.00 | 1.15 | 1.30 | 0.039 | 0.045 | 0.051 |
| E | 15.77 | 15.92 | 16.07 | 0.621 | 0.627 | 0.632 |
| E1(Option1) | 13.43 | 13.63 | 13.83 | 0.529 | 0.537 | 0.544 |
| E1(Option2) | 13.18 | 13.33 | 13.48 | 0.519 | 0.525 | 0.531 |
| E2 | 4.29 | 4.39 | 4.49 | 0.169 | 0.173 | 0.177 |
| E3 | 1.70 | 1.80 | 1.90 | 0.067 | 0.071 | 0.075 |
| e | 2.54BSC | | | 0.1000BSC | | |
| e1 | 5.08BSC | | | 0.2000BSC | | |
| N | 4 | | | 4 | | |
| L | 19.82 | 20.02 | 20.22 | 0.780 | 0.788 | 0.796 |
| L1 | 4.01 | 4.21 | 4.41 | 0.158 | 0.166 | 0.174 |
| P | 3.50 | 3.60 | 3.70 | 0.138 | 0.142 | 0.146 |
| P1 | 7.00 | 7.20 | 7.40 | 0.276 | 0.283 | 0.291 |
| Q | 5.65 | 5.75 | 5.85 | 0.222 | 0.226 | 0.230 |
| S | 6.07 | 6.17 | 6.27 | 0.239 | 0.243 | 0.247 |

NOTE:

- CONTROLLED DIMENSIONS ARE IN MILLIMETERS.

Part Marking

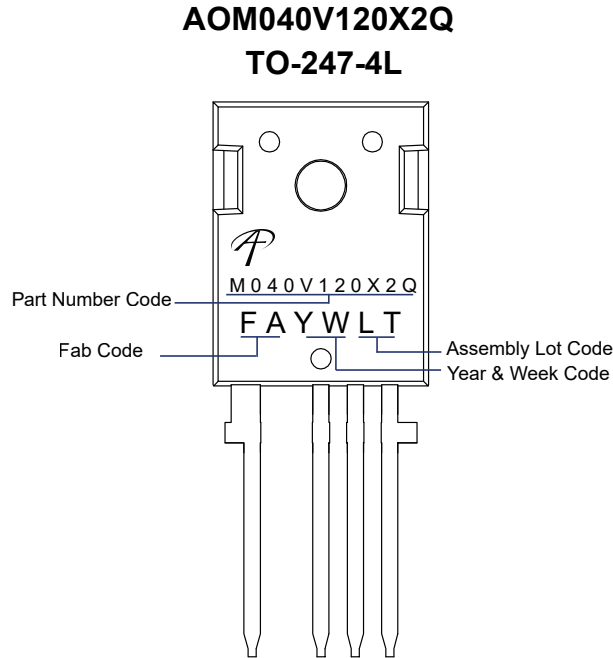

LEGAL DISCLAIMER

Applications or uses as critical components in life support devices or systems are not authorized. Alpha and Omega Semiconductor does not assume any liability arising out of such applications or uses of its products. AOS reserves the right to make changes to product specifications without notice. It is the responsibility of the customer to evaluate suitability of the product for their intended application. Customer shall comply with applicable legal requirements, including all applicable export control rules, regulations and limitations.

AOS's products are provided subject to AOS's terms and conditions of sale which are set forth at:

http://www.aosmd.com/terms_and_conditions_of_sale

LIFE SUPPORT POLICY

ALPHA AND OMEGA SEMICONDUCTOR PRODUCTS ARE NOT AUTHORIZED FOR USE AS CRITICAL COMPONENTS IN LIFE SUPPORT DEVICES OR SYSTEMS.

As used herein:

1. Life support devices or systems are devices or systems which, (a) are intended for surgical implant into the body or (b) support or sustain life, and (c) whose failure to perform when properly used in accordance with instructions for use provided in the labeling, can be reasonably expected to result in a significant injury of the user.
2. A critical component in any component of a life support, device, or system whose failure to perform can be reasonably expected to cause the failure of the life support device or system, or to affect its safety or effectiveness.