

General Description

The AOZ8851ADI is an ultra low capacitance one-line bi-directional transient voltage suppressor diode designed to protect high speed data lines and voltage sensitive electronics from high transient conditions and ESD.

The AOZ8851ADI comes in an RoHS compliant DFN package and is rated over a -40°C to +125°C ambient temperature range.

The ultra-small 0.62 x 0.32 x 0.3mm DFN package makes it ideal for applications where PCB space is a premium. The small size and high ESD protection makes it ideal for protecting voltage sensitive electronics from high transient conditions and ESD.

Features

- ESD protection for high-speed data lines:
 - IEC 61000-4-2 (ESD) immunity:
 - Air discharge: ±15 kV
 - Contact discharge: ±8 kV
 - IEC61000-4-5 (Surge 8/20 μs)
 - 1.5 A (VRWM=18V)
 - 1.3 A (VRWM=20V)
 - 1.2 A (VRWM=24V)
- Human Body Model (HBM) ±8 kV
- Bidirectional TVS
- Ultra low capacitance: 0.4 pF
- Maximum reverse working voltage: 18 V, 20 V, 24V
- Pb-free device

Applications

- USB Type-C
- Mobile phone
- Notebook computers
- Portable devices
- Digital cameras



Typical Application

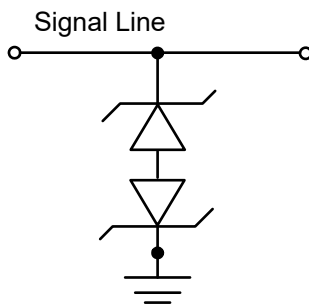

Pin Configuration

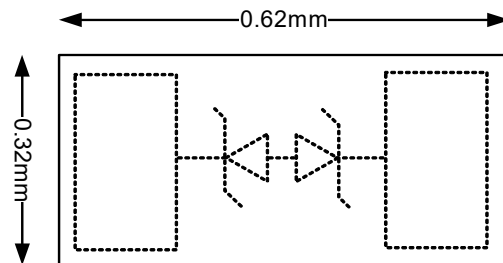

Ordering Information

Part Number	Ambient Temperature Range	Package	Environmental
AOZ8851ADI-18	-40 °C to +125 °C	DFN 0.62 x 0.32	Green Product
AOZ8851ADI-20			
AOZ8851ADI-24			



AOS Green Products use reduced levels of Halogens, and are also RoHS compliant. Please visit www.aosmd.com/media/AOSGreenPolicy.pdf for additional information.

Absolute Maximum Ratings

Exceeding the Absolute Maximum Ratings may damage the device.

Parameter	Rating		
	AOZ8851ADI-18	AOZ8851ADI-20	AOZ8851ADI-24
Any Pin to Pin	18 V	20 V	24 V
Peak Pulse Current (I_{PP}), $t_P = 8/20\mu s$	1.5 A	1.3 A	1.2 A
Peak Pulse Power (P_{PP}), $t_P = 8/20\mu s$	50 W	50 W	50 W
Storage Temperature (T_S)	-65°C to +150°C	-65°C to +150°C	-65°C to +150°C
ESD Rating per IEC61000-4-2, Contact ⁽¹⁾	±8 kV	±8 kV	±8 kV
ESD Rating per IEC61000-4-2, Air ⁽¹⁾	±15 kV	±15 kV	±15 kV
ESD Rating per Human Body Model ⁽²⁾	±8 kV	±8 kV	±8 kV

Notes:

- IEC 61000-4-2 discharge with $C_{Discharge} = 150$ pF, $R_{Discharge} = 330$ Ω.
- Human Body Discharge per MIL-STD-883, Method 3015 $C_{Discharge} = 100$ pF, $R_{Discharge} = 1.5$ kΩ.

Maximum Operating Conditions

The device is not guaranteed to operate beyond the Maximum Operating Conditions.

Parameter	Rating
Junction Temperature (T_J)	-40°C to +125°C

Electrical Characteristics

T_A = 25°C unless otherwise specified.

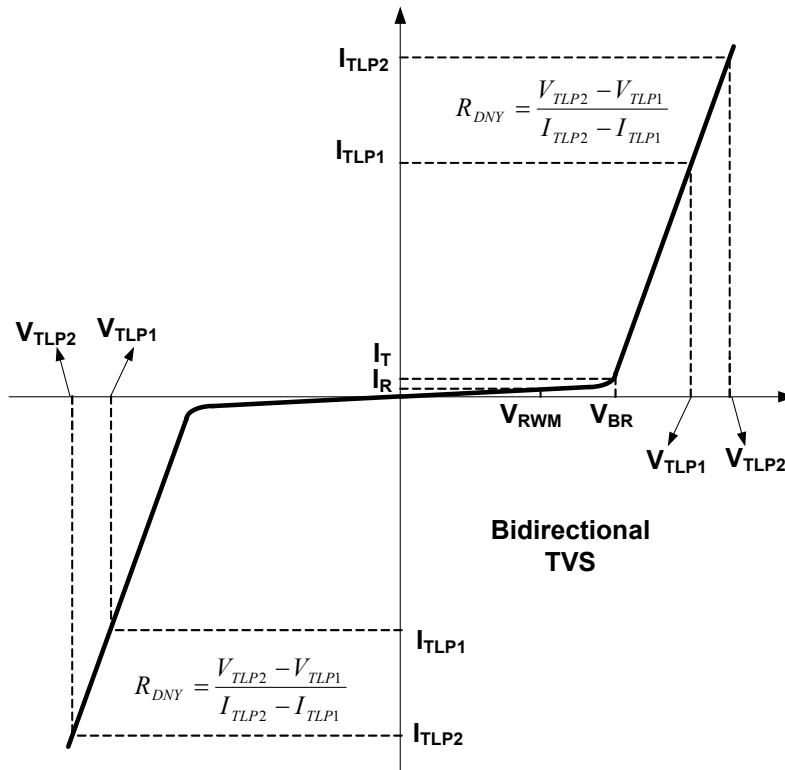

AOZ8851ADI-18						
Symbol	Parameter	Conditions	Min.	Typ.	Max.	Units
V _{RWM}	Reverse Working Voltage				18	V
V _{BR}	Reverse Breakdown Voltage	I _T = 1mA	20	23	25	V
I _R	Reverse Leakage Current	Max. V _{RWM}		1	100	nA
V _{CL}	Clamping Voltage ^(3,4) (100ns Transmission Line Pulse)	I _{TLP} =1A		26	30	V
		I _{TLP} =14A		76	88	
	Clamping Voltage ⁽³⁾ (IEC61000-4-5 Surge 8/20μs)	I _{PP} =1A		30	35	
R _{DNY}	Dynamic Resistance ^(3,4)	I _{TLP} =1 to 14A		4		Ω
C _J	Junction Capacitance	V _{IO} =0V, f=1MHz		0.4	0.7	pF

Electrical Characteristics (Continued)
 $T_A = 25^\circ\text{C}$ unless otherwise specified.

AOZ8851ADI-20						
Symbol	Parameter	Conditions	Min.	Typ.	Max.	Units
V_{RWM}	Reverse Working Voltage				20	V
V_{BR}	Reverse Breakdown Voltage	$I_T = 1\text{mA}$	22	25	28	V
I_R	Reverse Leakage Current	Max. V_{RWM}		1	100	nA
V_{CL}	Clamping Voltage ^(3,4) (100ns Transmission Line Pulse)	$I_{TLP}=1\text{A}$		30	35	V
		$I_{TLP}=10\text{A}$		70	77	
	Clamping Voltage ⁽³⁾ (IEC61000-4-5 Surge 8/20 μs)	$I_{PP}=1\text{A}$		36	42	
R_{DNY}	Dynamic Resistance ^(3,4)	$I_{TLP}=1$ to 10A		4		Ω
C_J	Junction Capacitance	$V_{IO}=0\text{V}$, $f=1\text{MHz}$		0.4	0.7	pF

AOZ8851ADI-24						
Symbol	Parameter	Conditions	Min.	Typ.	Max.	Units
V_{RWM}	Reverse Working Voltage				24	V
V_{BR}	Reverse Breakdown Voltage	$I_T = 1\text{mA}$	26.2	30	33	V
I_R	Reverse Leakage Current	Max. V_{RWM}		1	100	nA
V_{CL}	Clamping Voltage ^(3,4) (100ns Transmission Line Pulse)	$I_{TLP}=1\text{A}$		34	40	V
		$I_{TLP}=8\text{A}$		70	80	
	Clamping Voltage ⁽³⁾ (IEC61000-4-5 Surge 8/20 μs)	$I_{PP}=1\text{A}$		42	49	
R_{DNY}	Dynamic Resistance ^(3,4)	$I_{TLP}=1$ to 8A		5		Ω
C_J	Junction Capacitance	$V_{IO}=0\text{V}$, $f=1\text{MHz}$		0.4	0.7	pF

Notes:

3. These specifications are guaranteed by design and characterization.
4. Measurements performed using a 100ns Transmission Line Pulse (TLP) system.

Typical Performance Characteristics

Transmission Line Pulse
($t_p=0.2ns$, $t_p=100ns$)

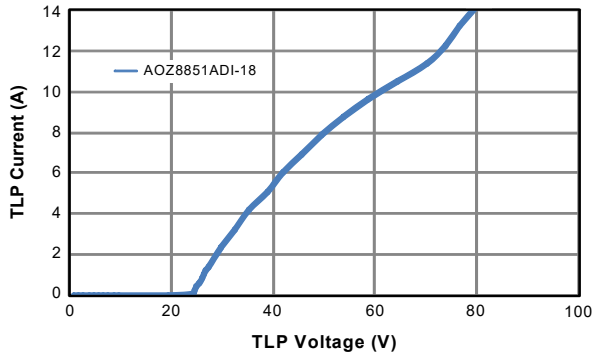

Typical Variation of CJ vs. VIN

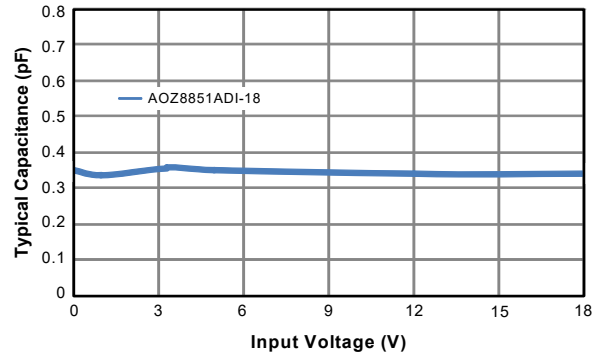

Transmission Line Pulse
($t_p=0.2ns$, $t_p=100ns$)

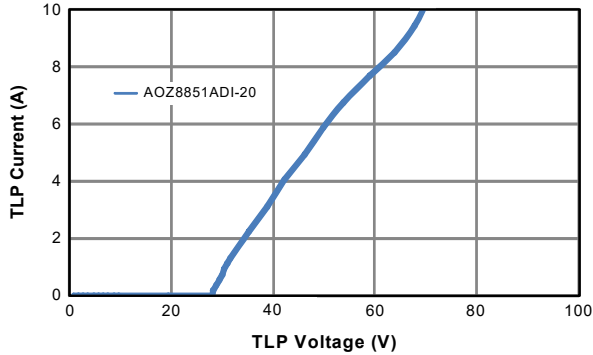

Typical Variation of CJ vs. VIN

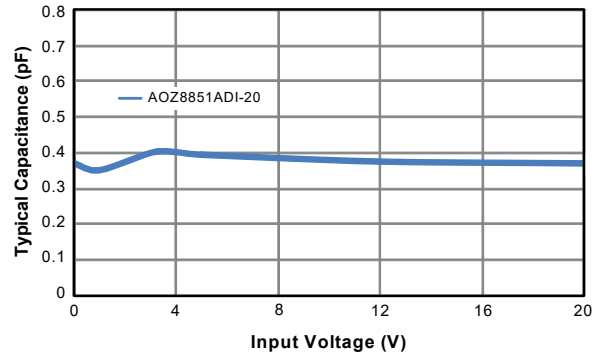

Transmission Line Pulse
($t_p=0.2ns$, $t_p=100ns$)

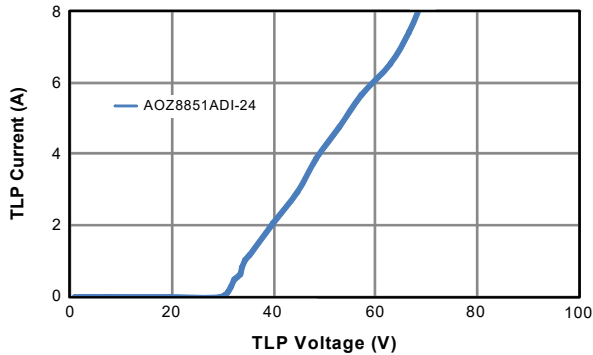

Typical Variation of CJ vs. VIN

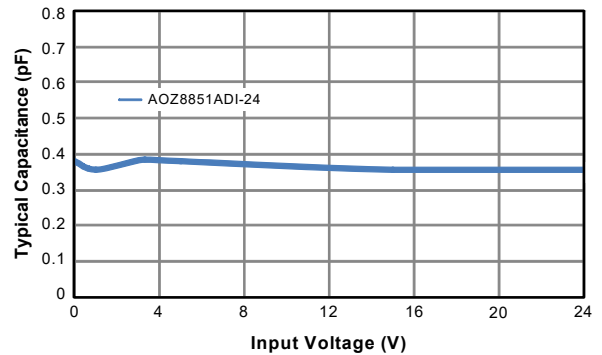

LEGAL DISCLAIMER

Applications or uses as critical components in life support devices or systems are not authorized. AOS does not assume any liability arising out of such applications or uses of its products. AOS reserves the right to make changes to product specifications without notice. It is the responsibility of the customer to evaluate suitability of the product for their intended application. Customer shall comply with applicable legal requirements, including all applicable export control rules, regulations and limitations.

AOS' products are provided subject to AOS' terms and conditions of sale which are set forth at:

http://www.aosmd.com/terms_and_conditions_of_sale

LIFE SUPPORT POLICY

ALPHA AND OMEGA SEMICONDUCTOR PRODUCTS ARE NOT AUTHORIZED FOR USE AS CRITICAL COMPONENTS IN LIFE SUPPORT DEVICES OR SYSTEMS.

As used herein:

1. Life support devices or systems are devices or systems which, (a) are intended for surgical implant into the body or (b) support or sustain life, and (c) whose failure to perform when properly used in accordance with instructions for use provided in the labeling, can be reasonably expected to result in a significant injury of the user.
2. A critical component in any component of a life support, device, or system whose failure to perform can be reasonably expected to cause the failure of the life support device or system, or to affect its safety or effectiveness.